

HYDAC INTERNATIONAL

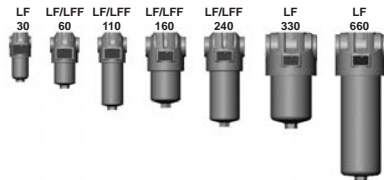

Inline Filter LF Inline Filter LFF for Reversible Oil Flow up to 500 l/min, up to 100 bar



1. TECHNICAL SPECIFICATIONS

1.1 FILTER HOUSING

Construction

The filter housings are designed in accordance with international regulations. They consist of a filter head and a screw-in filter bowl. LFF filters are suitable for flow in both directions.

Standard equipment:

- connection for a clogging indicator in filter head
- mounting holes in the filter head
- drain screw with pressure relief (LF 330 and above)

1.2 FILTER ELEMENTS

HYDAC filter elements are validated and their quality is constantly monitored according to the following standards:

- ISO 2941
- ISO 2942
- ISO 2943
- ISO 3724
- ISO 3968
- ISO 11170
- ISO 16889

Filter elements are available with the following pressure stability values:

Optimicron® (ON):	20 bar
Betamicron® (BH4HC):	210 bar
Optimicron® Pulse (ON/PS):	20 bar
Optimicron® Pulse (OH/PS):	210 bar
Wire mesh (W):	20 bar
Stainless steel fibre (V):	210 bar

1.3 FILTER SPECIFICATIONS

Nominal pressure	100 bar
Fatigue strength	At nominal pressure 10 ⁶ cycles from 0 to nominal pressure (For other pressures, see Point 1.8)
Temperature range	-30 °C to +100 °C
Material of filter head	Aluminium
Material of filter bowl	Aluminium
Type of clogging indicator	VM (differential pressure measurement up to 210 bar operating pressure)
Pressure setting of the clogging indicator	5 bar (others on request)
Bypass cracking pressure (optional)	6 bar (others on request)

1.4 SEALS

NBR (=Perbunan)

1.5 INSTALLATION

Inline filter with or without reversible oil flow

1.6 SPECIAL MODELS AND ACCESSORIES

- Bypass valve built into the head, separate from the main flow
- Oil drain screw up to LF/LFF 240
- Seals in FPM, EPDM
- Test and approval certificates

1.7 SPARE PARTS

See Original Spare Parts List

1.8 FATIGUE STRENGTH

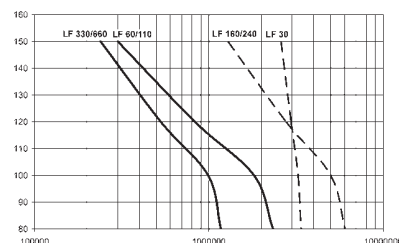

1.9 CERTIFICATES AND APPROVALS

On request

1.10 COMPATIBILITY WITH HYDRAULIC FLUIDS ISO 2943

- Hydraulic oils H to HLPD DIN 51524
- Lubrication oils DIN 51517, API, ACEA, DIN 51515, ISO 6743
- Compressor oils DIN 51506
- Biodegradable operating fluids VDMA 24568 HETG, HEEs, HEPG
- Fire-resistant fluids HFA, HFB, HFC and HFD
- Operating fluids with high water content (>50% water content) on request

1.11 IMPORTANT INFORMATION

- Filter housings must be earthed.
- When using electrical clogging indicators, the electrical power supply to the system must be switched off before removing the clogging indicator connector.

Symbol for hydraulic systems

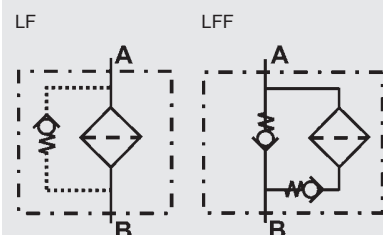

E 7.563.6/11.16

2. MODEL CODE (also order example)
LF ON 60 I C 10 D 1 . X /-L24
2.1 COMPLETE FILTER
Filter type

LF or LFF

Filter material

ON	Optimicron®	ON/PS	Optimicron® Pulse
BH/HC	Betamicron® (BH4HC)	OH/PS	Optimicron® Pulse
W	Stainl. st. wire mesh		
V	Stainless steel fibre		

Size of filter or element

 LF: 30, 60, 110, 160, 240, 330, 660
 LFF: 60, 110, 160, 240

Operating pressure

I = 100 bar

Type and size of connection

Type	Port	Filter size						
		30	60	110	160	240	330	660
B	G 1/2	•						
C	G 3/4		•	•				
E	G1 1/4				•	•		
F	G1 1/2						•	•

Filtration rating in µm

 ON: 1, 3, 5, 10, 15, 20 BH/HC, ON/PS, OH/PS, V: 3, 5, 10, 20
 W: 25, 50, 100, 200

Type of clogging indicator

Y	plastic blanking plug in indicator port] for other clogging indicators, see brochure no. 7.050../..
A	stainless steel blanking plug in indicator port	
B	visual	
C	electrical	
D	visual and electrical	

Type code

1

Modification number

X the latest version is always supplied

Supplementary details

B.	bypass cracking pressure (e.g. B6 = 6 bar); without details = without bypass valve	
L...	light with appropriate voltage (24V, 48V, 110V, 220V)] only for clogging indicators
LED	2 light emitting diodes up to 24 Volt] type "D"
SO184	pressure release/oil drain screw (standard for LF 330 and above)	
V	FPM seals	
W	suitable for HFA, HFC oil-water emulsions	
	(only necessary when using a clogging indicator or V or W elements)	

2.2 REPLACEMENT ELEMENT
0060 D 010 ON /-V
Size

0030, 0060, 0110, 0160, 0240, 0330, 0660

Type

D

Filtration rating in µm

 ON: 001, 003, 005, 010, 015, 020 BH4HC, ON/PS, OH/PS, V: 003, 005, 010, 020
 W: 025, 050, 100, 200

Filter material

ON, BH4HC, ON/PS, OH/PS, V, W

Supplementary details

V, W (for descriptions, see Point 2.1)

2.3 REPLACEMENT CLOGGING INDICATOR
VM 5 D . X /-L24
Type of indicator

VM Differential pressure indicator up to 210 bar operating pressure

Pressure setting

5	standard for LF filters 5 bar] others on request
8	standard for LFF filters 8 bar	

Type of clogging indicator

D (see Point 2.1)

Modification number

X the latest version is always supplied

Supplementary details

L..., LED, V, W (for descriptions, see Point 2.1)

3. FILTER CALCULATION / SIZING

The total pressure drop of a filter at a certain flow rate Q is the sum of the housing Δp and the element Δp and is calculated as follows:

$$\Delta p_{\text{total}} = \Delta p_{\text{housing}} + \Delta p_{\text{element}}$$

$$\Delta p_{\text{housing}} = \text{(see Point 3.1)}$$

$$\Delta p_{\text{element}} = Q \cdot \frac{SK^*}{1000} \cdot \frac{\text{viscosity}}{30}$$

(*see Point 3.2)

For ease of calculation, our Filter Sizing Program is available on request free of charge.

NEW: Sizing online at www.hydac.com

3.1 Δp -Q HOUSING CURVES BASED ON ISO 3968

The housing curves apply to mineral oil with a density of 0.86 kg/dm³ and a kinematic viscosity of 30 mm²/s. In this case, the differential pressure changes proportionally to the density.

LF 30

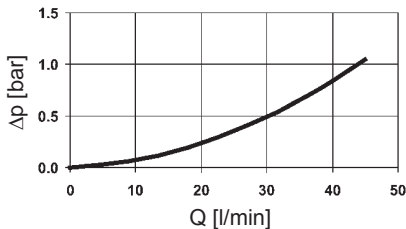

LF 60-110

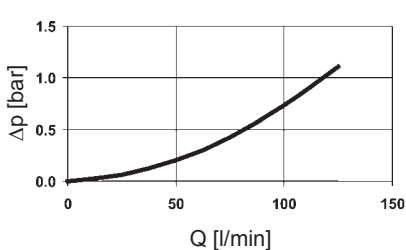

LF 160-240

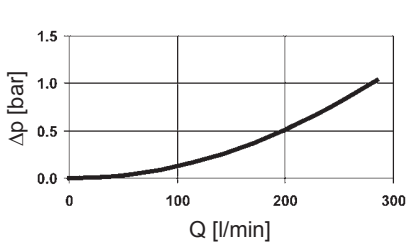

LF 330-660

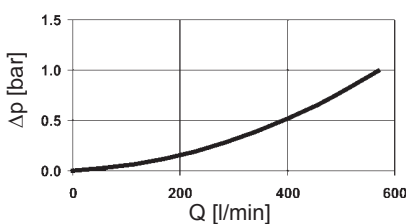

LFF Δp -Q housing curves on request!

3.2 GRADIENT COEFFICIENTS (SK) FOR FILTER ELEMENTS

The gradient coefficients in mbar/(l/min) apply to mineral oils with a kinematic viscosity of 30 mm²/s. The pressure drop changes proportionally to the change in viscosity.

LF/ LFF	ON					
	1 μm	3 μm	5 μm	10 μm	15 μm	20 μm
30	77.8	63.9	43.3	22.8	14.0	11.3
60	53.5	26.0	18.3	12.1	9.78	6.32
110	25.8	13.4	9.61	6.06	4.63	2.99
160	18.5	11.0	7.70	4.10	3.71	3.18
240	11.5	6.90	5.34	3.19	2.44	2.10
330	8.23	4.19	3.37	2.46	1.55	1.22
660	3.78	1.93	1.56	0.93	0.71	0.56

LF/ LFF	ON/PS				OH/PS			
	3 μm	5 μm	10 μm	20 μm	3 μm	5 μm	10 μm	20 μm
30	63.90	43.30	25.08	11.30	87.54	59.32	34.36	15.48
60	28.90	20.40	14.52	7.90	39.59	27.95	19.89	10.82
110	14.90	10.70	7.26	3.70	20.41	14.66	9.95	5.07
160	13.10	8.80	5.52	3.50	17.95	12.06	7.56	4.80
240	8.20	6.10	4.32	2.30	11.23	8.36	5.92	3.15
330	4.86	3.90	3.00	1.70	6.66	5.34	4.11	2.33
660	2.25	1.80	1.10	0.80	3.08	2.47	1.51	1.10

LF/ LFF	V				W	BH4HC			
	3 μm	5 μm	10 μm	20 μm		3 μm	5 μm	10 μm	20 μm
30	18.4	13.5	7.5	3.6	3.030	91.2	50.7	36.3	19.0
60	16.0	9.3	5.4	3.3	0.757	58.6	32.6	18.1	12.2
110	8.2	5.6	3.3	2.2	0.413	25.4	14.9	8.9	5.6
160	4.6	3.2	2.3	1.4	0.284	16.8	10.4	5.9	4.4
240	3.1	2.5	1.7	1.1	0.189	10.6	6.8	3.9	2.9
330	2.2	1.8	1.2	0.8	0.138	7.7	4.5	2.8	2.0
660	1.1	0.9	0.6	0.4	0.069	3.3	1.9	1.0	0.9

4. DIMENSIONS

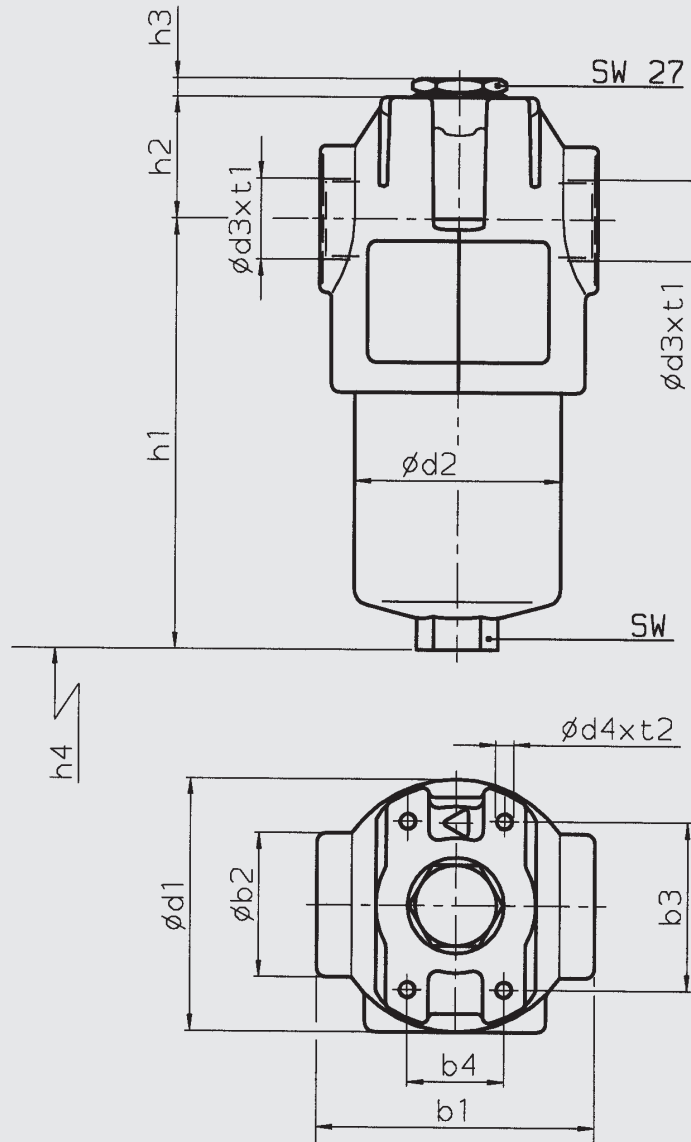

LF / LFF	b1	b2	b3	b4	d1	d2	d3	d4	h1	h2	h3	h4	SW	t1	t2	Weight including element [kg]	Volume of pressure chamber [l]
30	69	36	45	30	67	52	G $\frac{1}{2}$	M5	125.5	31	7	75	24	15	8	0.8	0.13
60	90	48	56	32	84	68	G $\frac{3}{4}$	M6	137.5	39	6	75	27	17	9	1.5	0.24
110	90	48	56	32	84	68	G $\frac{3}{4}$	M6	207.0	39	6	75	27	17	9	1.8	0.42
160	125	65	85	35	116	95	G1 $\frac{1}{4}$	M10	190.5	46	6	95	32	21	14	3.7	0.60
240	125	65	85	35	116	95	G1 $\frac{1}{4}$	M10	250.5	46	6	95	32	21	14	4.3	0.80
330	159	85	115	60	160	130	G1 $\frac{1}{2}$	M12	252.5	50	6	105	36	23	17	8.0	1.50
660	159	85	115	60	160	130	G1 $\frac{1}{2}$	M12	423.5	50	6	105	36	23	17	11.0	3.00

NOTE

The information in this brochure relates to the operating conditions and applications described.
 For applications or operating conditions not described, please contact the relevant technical department.
 Subject to technical modifications.

HYDAC Filtertechnik GmbH
 Industriegebiet
D-66280 Sulzbach/Saar
 Tel.: 0 68 97 / 509-01
 Fax: 0 68 97 / 509-300
 Internet: www.hydac.com
 E-Mail: filter@hydac.com