

Technical Information

Load Sensing Steering Units

OSP/C/F/D/L LS, OLS Priority Valves,
OSQ Flow Amplifiers

powersolutions.danfoss.com

Archivierung 10/2017

Revision history
Table of revisions

Date	Changed	Rev
June 2017	Overview regarding steering components; Literature reference table: Technical data chapter; Port thread versions; Dimensions for OSPC/OSPF 230; Specification table for non catalogue numbers of Danfoss Priority Valves; and Flow and pressure table	0701
July 2016	Updated text under OSPD LS: Steering unit load sensing dynamic with 2 rotary meters and with integrated valve functions	0601
April 2016	Updated to Engineering Tomorrow design	0503
February 2016	Update image OSPC LS/LSR and OSPF LS for OLS, OSPCX LS for OSQ	0502
September 2014	Various updates	EA
February 2014	Converted to Danfoss layout - DITA CMS	DA
August 2013	OSPQ deleted	CA
November 2009	Steering column deleted	BA
May 2006	First version	AA

Contents
A wide range of steering components

Conversion factors.....	6
Survey of literature with technical data on Danfoss steering components.....	6

LS Steering Units OSPB, OSPC, OSPF, OSPD, OSPL

Versions.....	7
OSPB LS: Steering unit with no valve functions.....	7
OSPC LS: Steering unit load sensing with integrated valve functions for in line priority valve OLS.....	8
OSPC LS: Steering unit load sensing with integrated valve functions for flange on priority valve OLSA.....	8
OSPC LSR: Steering unit load sensing dynamic with integrated valve functions.....	9
OSPF LS : Steering unit full drain load sensing dynamic and with integrated valve functions.....	9
OSPD LS: Steering unit load sensing dynamic with 2 rotary meters and with integrated valve functions.....	10
OSPL LS:.....	10
OSPBX LS, OSPCX LS and OSPLX LS: Steering units load sensing for flow amplifiers.....	12
Code numbers and weights.....	13
OSPB load sensing static non-reaction steering units.....	13
OSPB load sensing dynamic non-reaction steering units.....	13
OSPC load sensing static non-reaction steering unit.....	14
OSPC load sensing dynamic non-reaction steering units.....	14
OSPC load sensing dynamic reaction steering units.....	15
OSPF load sensing dynamic non-reaction steering units.....	15
OSPD load sensing non-reaction steering units.....	16
OSPL load sensing static non-reaction steering units.....	17
OSPL load sensing dynamic non-reaction steering units.....	17
OSPBX and OSPLX load sensing static steering units for OSQ static.....	18
OSPCX load sensing dynamic steering units for OSQ dynamic.....	18
Specification table for non catalogue numbers of LS Steering Units.....	20
Technical data.....	21
Displacement, flow and pressure: OSPB LS, OSPC LS, OSPC LSR.....	21
Displacement, flow and pressure: OSPF LS.....	23
Displacement, flow and pressure: OSPD LS.....	23
Displacement, flow and pressure: OSPL LS, OSPBX LS, OSPCX LS, OSPLX LS.....	24
Valve functions in OSPC, OSPF, OSPD and OSPL LS steering units.....	25
Pilot pressure relief valve; (P - T, Qp) characteristic.....	25
Shock valves.....	25
Suction valves.....	25
Check valves.....	26
Port thread versions for OSPB LS, OSPC LS/LSR, OSPF LS, OSPD LS/LSR, OSPL LS, OSPBX LS, OSPCX LS, OSPLX LS.....	27
Dimensions.....	29
OSPB LS for OLS, OSPBX LS for OSQ.....	29
OSPC LS/LSR and OSPF LS for OLS, OSPCX LS for OSQ.....	30
OSPD LS/LSR for OLS.....	32
OSPL LS for OLS and OSPLX LS for OSQ.....	33
OSPL 1200 LS for OLS.....	35

Valve Block OVPL

Versions.....	36
Code numbers and weight.....	37
Technical data.....	40
Common data.....	40
Valve functions.....	40
Shock valves.....	40
Suction valves.....	41
Check valve.....	41
Backpressure valve.....	41
Installation.....	42
Dimensions.....	43

Contents
Angle Block OVR

Version.....	45
Code numbers and weight.....	45
Installation.....	45
Dimensions.....	46

Priority Valves OLSA and OLS

Versions.....	47
System sizing.....	49
Code numbers and weights.....	50
OLS/OLSA static priority valves for load sensing static steering units.....	50
OLS/OLSA static priority valves for load sensing statics steering units.....	51
OLS/OLSA dynamic priority valves for load sensing dynamic steering units.....	51
OLS/OLSA dynamic priority valves for load sensing dynamic steering units.....	52
OLS dynamic priority valves for OSPF LS and OSPU LS dynamic steering units.....	53
Specification table for non catalogue numbers of Danfoss Priority Valves.....	55
Technical data.....	56
Max. pressure on connections.....	56
Pressure drop in priority valves.....	56
Pressure drop P-EF for static priority valves.....	56
Pressure drop P-EF for dynamic priority valves.....	58
Pressure drop P-EF for OLSP static priority valves.....	60
Pressure drop P-EF for OLSP dynamic priority valves.....	61
Pressure drop P-EF for OLS 320 static priority valves.....	61
Pressure drop P-EF for OLS 320 dynamic priority valves.....	62
OLS 160 and OLS 320, pilot pressure relief valve (P - T, Qp) characteristics.....	62
Dimensions.....	64

Flow Amplifiers OSQA, OSQB and OSQB/OLSQ

Versions.....	71
OSQA and OSQB static.....	71
OSQB dynamic with OLSQ priority valve for emergency steering.....	72
Code numbers and weights.....	72
OSQA and OSQB static flow amplifiers for load sensing static steering units.....	72
OSQB/OLSQ dynamic flow amplifier for load sensing dynamics steering units.....	72
Specification table for non catalogue numbers of Danfoss Flow Amplifier.....	74
Technical data.....	75
Flow and pressure.....	75
Total displacement of Steering System.....	75
Installation.....	75
Valve functions in the flow amplifiers.....	75
Priority valve.....	75
OSQ pilot pressure relief valve (HP - HT, Qp) characteristic.....	76
Back pressure valve.....	77
Shock valves.....	78
Suction valves.....	78
Priority valve OLSQ for emergency circuit in OSQB/OLSQ.....	78
Dimensions.....	80
OSQA.....	80
OSQB.....	82
OSQB with OLSQ.....	84

A wide range of steering components

hfa1391605590092

Danfoss is one of the largest producers in the world of steering components for hydrostatic steering systems on off-road vehicles. Danfoss offers steering solutions both at component and system levels. Our product range makes it possible to cover applications of all types, ranging from ordinary 2 wheel steering (also known as Ackermann steering) to articulated steering, automatic steering (for example, by sensor) and remote controlled steering via satellite. We can offer more than 1,800 different steering units and 250 different priority valves categorized in types, variants and sizes.

For hydrostatic steering systems, Danfoss offers:

- Mini steering units with displacements from 32 to 100 cm³/rev [1.95 to 6.10 in³/rev], flow up to 20 l/min [5.28 US gal/min], steering pressure up to 140 bar [2030 psi].
- Steering units with displacements from 40 to 1200 cm³/rev [2.44 to 73.2 in³/rev], flow up to 100 l/min [26.4 US gal/min], steering pressure up to 240 bar [3481 psi].
- Priority valves for rated flows at 40, 80, 120, 160 and 320 l/min [10.6, 21.1, 31.7, 42.3 and 84.5 US gal/min], pressure up to 350 bar [5076 psi].
- Pilot operated flow-amplifiers with amplification factors of 4, 5, 8, 10 or 20 for rated oil flows of 240 and 400 l/min [63.4 and 105.7 US gal/min], steering pressure up to 240 bar [3480 psi].
- Pilot operated steering valve with steering flow up to 100 l/min [26.4 US gal/min], steering pressure up to 250 bar [3625 psi] and with integrated priority valve for pump flow up to 120 l/min [31.7 US gal/min].

For electrohydraulic steering systems Danfoss offers:

- Pilot operated steering valves (pilot operated by hydrostatic steering unit or by electrical signal) with steering flows up to 100 l/min [26.4 US gal/min], steering pressure up to 250 bar [3625 psi].
- Steering units with integrated electrical operated steering valve with steering flow up to 50 l/min [13.2 US gal/min], steering pressure up to 210 bar [3045 psi].
- Electrical operated steering valve with steering flow up to 70 l/min [18.5 US gal/min], steering pressure up to 210 bar [3045 psi].

Characteristic features for steering units:

- Low steering torque: From 0.5 N·m to 3 N·m in normal steering situations
- Low noise level
- Low pressure drop

A wide range of steering components

- Many types available: Open center Non-reaction, Open center Reaction, Power Beyond, Closed center Non-reaction, Load Sensing, Load Sensing Reaction
- One or more built-in valve functions: relief valve, shock valves, suction valves, non-return valve in P-line and in LS-line
- Optional port connections (according to ISO, SAE or DIN standards)

Characteristic features for electrohydraulic steering systems with OSPE, EHPS, and EHi:

- Possibility of GPS, row sensor, variable steering ratio and joystick steering
- The possibility of manual steering even on very heavy vehicles
- EHPS: High steering pressure requiring smaller cylinders and flow
- EHPS: Low pilot pressure and flow giving extremely low noise in the cabin
- EHPS: Can be combined with Danfoss PVG 32 proportional valve

Conversion factors

1 N·m = [8.851 lbf·in]	1 l = [0.264 US gal]
1 N = [0.2248 lbf]	1 bar = [14.5 psi]
1 mm = [0.0394 in]	°F = [1.8°C + 32]
1 cm ³ = [0.061 in ³]	

Survey of literature with technical data on Danfoss steering components

Detailed data on all Danfoss steering components and accessories can be found in our steering component catalogues, which is divided in to the following individual sub catalogues:

General information	Steering components
Technical data on mini steering units	OSPM
Technical data on open center, and closed center steering units	OSPB, OSPC, and OSPD
Technical data on load sensing steering units, priority valves and flow amplifiers	OSPB, OSPC, OSPF, OSPD, OSPL, OSPBX, OSPLX, OVPL, OLS and OSQ
Technical data on load sensing steering unit with amplification	OSPU
Technical data on hydraulic and electrohydraulic pilot operated steering valves, electrical actuation modules and appropriate steering units.	EHPS, EHPS w. OLS 320, PVE for EHPS and OSPCX
Technical data on combined steering unit/ electrohydraulic steering valves and steering wheel sensors	OSPE
Technical data on electrohydraulic steering valves	EHi
Technical data on steering wheel sensors	SASA

For technical information on individual variants, please contact the Danfoss Sales Organization.

LS Steering Units OSPB, OSPC, OSPF, OSPD, OSPL

Versions

Load sensing

In load sensing steering systems both the steering system and the working hydraulics can be supplied with oil from the same pump, using a load sensing pump, also delivers the potential for energy saving.

Load sensing steering units have an extra connection for load sensing (LS), so that a load pressure signal can be directed via the steering unit to a Danfoss priority valve and/or an LS pump. The load sensing signal controls the oil flow from the priority valve (and/or the LS pump) to the steering unit. The LS connection is open to tank when the steering unit is in the neutral position.

Load sensing static

Load sensing static steering units require load sensing static priority valves and/or load sensing static variable displacement pumps. Load sensing static steering systems have no oil flow in the LS connection when the steering unit is in neutral position.

Load sensing dynamic

Load sensing dynamic steering units require load sensing dynamic priority valves and/or load sensing dynamic variable displacement pumps. Load sensing dynamic steering systems have a constant oil flow in the LS connection in the direction of the steering unit even when the steering unit is in neutral position.

Reaction

With reaction steering units any external forces acting on the steered wheels result in a corresponding movement of the steering wheel when the driver is not steering the vehicle.

Non-reaction

With non-reaction steering units there is no corresponding movement of the steering wheel when the driver is not steering the vehicle

OSPB LS: Steering unit with no valve functions

OSPB LS (OLS)
Load sensing static non-reaction and load sensing dynamic non-reaction



Top: Danfoss diagram; bottom: CETOP diagram

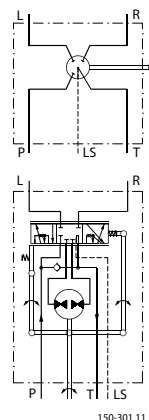

Technical Information

OSP/C/F/D/L LS Steering Units, OLS Priority Valves, OSQ Flow Amplifiers

LS Steering Units OSPB, OSPC, OSPF, OSPD, OSPL

OSPC LS: Steering unit load sensing with integrated valve functions for in line priority valve OLS

OSPC LS (OLS)
Load sensing dynamic non-reaction

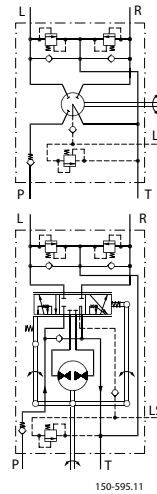

OSPC LS: Steering unit load sensing with integrated valve functions for flange on priority valve OLSA

OSPC LS (OLSA)
Load sensing dynamic non-reaction

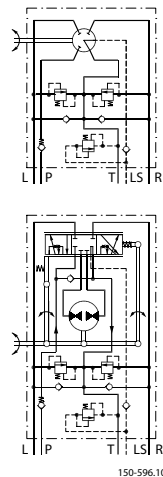

Technical Information

OSP/C/F/D/L LS Steering Units, OLS Priority Valves, OSQ Flow Amplifiers

LS Steering Units OSPB, OSPC, OSPF, OSPD, OSPL

OSPC LSR: Steering unit load sensing dynamic with integrated valve functions

OSPC LSR (OLS)
Load sensing dynamic reaction

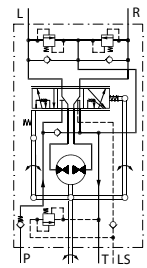
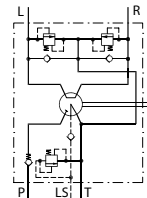

150-598.11

OSPF LS : Steering unit full drain load sensing dynamic and with integrated valve functions

OSPF LS (OLS)
Load sensing dynamic non-reaction

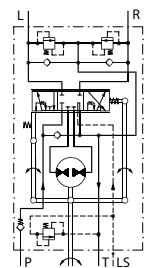
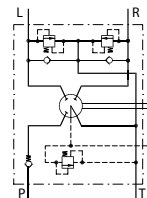

150-597.11

Technical Information

OSP/C/F/D/L LS Steering Units, OLS Priority Valves, OSQ Flow Amplifiers
LS Steering Units OSPB, OSPC, OSPF, OSPD, OSPL
OSPD LS: Steering unit load sensing dynamic with 2 rotary meters and with integrated valve functions

The OSPD has 2 rotary meters (gear wheel sets). Should the pump supply be lost, only one rotary meter will be active: OSPD displacement will be low for emergency steering (only one rotary meter active) for pressure P-T <3 bar. Displacement will be high for pressure P-T >5 bars: both rotary meters are active.

OSPD LS (OLS)
 Load sensing dynamic non-reaction



F300 612

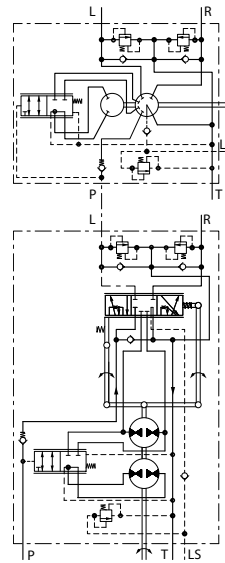

150-599.11

OSPL LS:

Steering unit load sensing for high steering flow, displacement larger than 500 cm³/rev [30.5 in³/rev].

OSPL LS (OLS) - Load sensing static non-reaction



F300 611

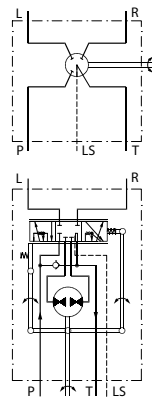

150-301.11

Technical Information

OSP/C/F/D/L LS Steering Units, OLS Priority Valves, OSQ Flow Amplifiers

LS Steering Units OSPB, OSPC, OSPF, OSPD, OSPL

OSPL LS (OLS) - Load sensing dynamic non-reaction

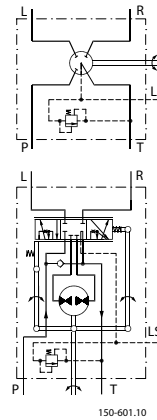

OSPL 1200 (OLS) Load sensing dynamic non-reaction

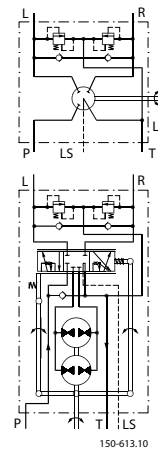

LS Steering Units OSPB, OSPC, OSPF, OSPD, OSPL
OSPBX LS, OSPCX LS and OSPLX LS: Steering units load sensing for flow amplifiers

OSPBX LS, OSPCX LS and OSPX LS are load sensing steering units with the L and the R connections open to tank when in neutral position. OSPBX LS, OSPCX LS and OSPX LS can only be used with Danfoss flow-amplifiers OSQA or OSQB. OSPBX LS, OSPCX LS and OSPX LS steering units must not be connected directly to the steering cylinder. OSPCX LS is for OSQ dynamic without pilot pressure relief valve.

OSPBX LS, OSPLX LS - Load sensing static

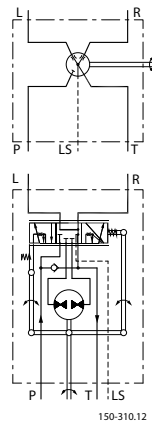

150-310.12

OSPCX LS - Load sensing dynamic

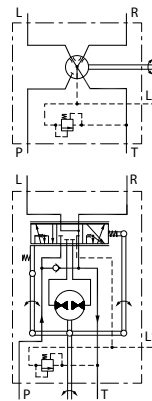

150-602.10

Technical Information

OSP/C/F/D/L LS Steering Units, OLS Priority Valves, OSQ Flow Amplifiers
LS Steering Units OSPB, OSPC, OSPF, OSPD, OSPL
Code numbers and weights
OSPB load sensing static non-reaction steering units

OSPB LS Static steering units have no valve functions.

 OSPB LS in the table below have all standard neutral setting springs, see [Specification Table for Non Catalogue Numbers of LS Steering Units](#)

Steering unit	Code Numbers		Weight kg [lb]
	Connections		
	European version for OLS G 1/2 G 1/4 - S ^{**})	US version for OLS 3/4-16 UNF - O ^{*)} 7/16-20 UNF - O ^{*)} + S ^{**})	
OSPB 50 LS	-	150G6085	5.2 [11.46]
OSPB 80 LS	-	150G6086	5.3 [11.68]
OSPB 100 LS	-	150G6087	5.4 [11.90]
OSPB 125 LS	-	150G6088	5.5 [12.13]
OSPB 160 LS	-	150G6089	5.6 [12.35]
OSPB 200 LS	150-0103	150G6090	5.8 [12.79]
OSPB 315 LS	150-0104	150-0116	6.2 [13.67]
OSPB 400 LS	150-0105	150-0117	7.0 [15.43]

^{*)} O-ring chamfer on port connections

^{**)} Spot face around port connection

Valve blocks OVP and OVR can be mounted on all of the OSPB steering units from the above table.

OSPB load sensing dynamic non-reaction steering units

OSPB LS Dynamic steering units have no valve functions.

 OSPB LS in the table below have all standard neutral setting springs, see [Specification Table for Non Catalogue Numbers of LS Steering Units](#)

Steering unit	Code Numbers	Weight kg [lb]
	Connections US version for OLS 3/4-16 UNF - O ^{*)} 7/16-20 UNF - O ^{*)} + S ^{**})	
OSPB 50 LS	150-8204	5.2 [11.46]
OSPB 80 LS	150-8205	5.3 [11.68]
OSPB 100 LS	150-8206	5.4 [11.90]
OSPB 125 LS	150-8207	5.5 [12.13]
OSPB 160 LS	150-8208	5.6 [12.35]
OSPB 200 LS	150-8209	5.8 [12.79]
OSPB 315 LS	150-8210	6.2 [13.67]
OSPB 400 LS	150-8211	7.0 [15.43]

^{*)} O-ring chamfer on port connections

^{**)} Spot face around port connection

Valve blocks OVP and OVR can be mounted on all of the OSPB steering units from the above table

LS Steering Units OSPB, OSPC, OSPF, OSPD, OSPL
OSPC load sensing static non-reaction steering unit

OSPC LS Static steering units in the table below incorporate all the following valve functions:

- check valve in P-port
- pilot pressure relief valve
- shock valves
- suction valves

OSPC LS in the table below have all standard neutral setting springs, see [Specification Table for Non Catalogue Numbers of LS Steering Units](#)

Steering unit	Code numbers			Valve settings		Weight kg [lb]
	Connections			Relief valve bar [psi]	Shock valve bar [psi]	
	European for OLS G 1/2 G 1/4 - S ^{**})	European and US version for OLSA	US version for OLS 3/4-16 UNF - O ^{*)} 7/16-20 UNF - O ^{*)} + S ^{**})			
OSPC 80 LS	150-1230	150-1188	150-1222	170 [2465]	225 [3263]	5.3 [11.68]
OSPC 100 LS	150-1231	150-1189	150-1221			5.4 [11.90]
OSPC 125 LS	150-1232	150-1190	150-1220			5.5 [12.13]
OSPC 160 LS	150-1233	150-1191	150-1219			5.6 [12.35]
OSPC 200 LS	150-1234	150-1192	150-1218			5.8 [12.79]
OSPC 315 LS	150-1235	-	150G6091			6.2 [13.67]
OSPC 400 LS	150-1240	-	-			7.0 [15.43]

^{*)} O-ring chamfer on port connections

^{**}) Spot face around port connections

If you require other port connections, valve combinations and/or other valve settings or other displacements, please fill in the order form in the [Specification Table for Non Catalogue Numbers of LS Steering Units](#) and contact the Danfoss Sales Organization.

OSPC load sensing dynamic non-reaction steering units

OSPC LS Dynamic steering units in the table below incorporate all the following valve functions:

- check valve in P-port
- pilot pressure relief valve
- shock valves
- suction valves
- check valve in LS-line for all OSPC LS Dynamic up to and including 200 cm³/rev

OSPC LS in the table below have all standard neutral setting springs, see [Specification Table for Non Catalogue Numbers of LS Steering Units](#)

LS Steering Units OSPB, OSPC, OSPF, OSPD, OSPL

Steering unit	Code numbers			Valve settings		Weight kg [lb]
	Connections			Relief valve bar [psi]	Shock valve bar [psi]	
	European version for OLS G 1/2 - S ^{**} G 1/4 - S ^{**})	European and US version for OLSA	US version for OLS 3/4-16 UNF - O ^{*)} 7/16-20 UNF - O ^{*)} +S ^{**})			
OSPC 50 LS	150-8233	150-8222	150-8215	140 [2030]	200 [2900]	5.2 [11.46]
OSPC 80 LS	150-8234	150-8223	150-8216	170 [2465]	225 [3263]	5.3 [11.68]
OSPC 100 LS	150-8235	150-8224	150-8217			5.4 [11.90]
OSPC 125 LS	150-8236	150-8225	150-8218			5.5 [12.13]
OSPC 160 LS	150-8237	150-8226	150-8219			5.6 [12.35]
OSPC 200 LS	150-8238	150-8227	150-8220			5.8 [12.79]
OSPC 315 LS	150-8239	-	150-8221			6.2 [13.67]
OSPC 400 LS	150-8240	-	-			7.0 [15.43]

^{**}) Spot face around port connections

^{*)} O-ring chamfer on port connections

If you require other port connections, valve combinations and/or other valve settings or other displacements please fill in the order form in the [Specification Table for Non Catalogue Numbers of LS Steering Units](#) and contact the Danfoss Sales Organization.

OSPC load sensing dynamic reaction steering units

OSPC LSR Dynamic steering units in the table below incorporate all the following valve functions:

- check valve in P-port
- pilot pressure relief valve
- shock valves
- suction valves
- check valve in LS-line

OSPC LSR in the table below have all standard neutral setting springs, see [Specification Table for Non Catalogue Numbers of LS Steering Units](#)

Steering unit	Code numbers	Valve settings		Weight kg [lb]
	Connections European version for OLS G 1/2 - S ^{**} G 1/4 - S ^{**})	Relief valve bar [psi]	Shock valve bar [psi]	
OSPC 80 LSR	150-8241	170 [2465]	225 [3263]	5.3 [11.68]
OSPC 200 LSR	150-8242			5.8 [12.79]

^{**}) Spot face around port connections (can not be used in connection with OVR angular block)

If you require other port connections, valve combinations, valve settings and/or other displacements, please fill in the order form in the [Specification Table for Non Catalogue Numbers of LS Steering Units](#) and contact the Danfoss Sales Organization.

OSPF load sensing dynamic non-reaction steering units

OSPF LS Dynamic steering units in the table below incorporate all the following valve functions:

LS Steering Units OSPB, OSPC, OSPF, OSPD, OSPL

- check valve in P-port
- pilot pressure relief valve
- shock valves
- suction valves

OSPF LS in the table below have all soft neutral setting springs, see [Specification Table for Non Catalogue Numbers of LS Steering Units](#)

Steering unit	Code numbers	Valve settings		Weight kg [lb]
	Connections European version for OLS G 1/2 - S** G 1/4 - S**	Relief valve bar [psi]	Shock valve bar [psi]	
OSPF 80 LS	150G5079	170 [2465]	225 [3263]	5.3 [11.68]
OSPF 100 LS	150G5080			5.4 [11.90]
OSPF 125 LS	150G5081			5.5 [12.13]
OSPF 160 LS	150G5082			5.6 [12.35]
OSPF 200 LS	150G5083			5.8 [12.79]
OSPF 315 LS	150G5084			6.2 [13.67]
OSPF 400 LS	150G5085			7.0 [15.43]

** Spot face around port connections (can not be used in connection with OVR angular block)

If you require other port connections, valve combinations, valve settings and/or other displacements, please fill in the order form in the [Specification Table for Non Catalogue Numbers of LS Steering Units](#) and contact the Danfoss Sales Organization.

OSPD load sensing non-reaction steering units

OSPD LS Dynamic steering units in the table below incorporate all the following valve functions:

- check valve in P-port
- pilot pressure relief valve
- shock valves
- suction valves
- check valve in LS-line

OSPD LS in the table below have all standard neutral setting springs, see [Specification Table for Non Catalogue Numbers of LS Steering Units](#)

Steering unit	Code numbers	Valve settings		Weight kg [lb]
	Connections European version G 1/2 - S** G 1/4 - S**	Relief valve bar [psi]	Shock valve bar [psi]	
OSPD 70/230 LS	11113141	170 [2465]	225 [3263]	7.7 [17.00]
OSPD 70/270 LS	11113142			7.9 [17.41]
OSPD 70/385 LS	11113143			8.4 [18.52]
OSPD 125/325 LS	11113146			8.1 [12.79]
OSPD 125/440 LS	11113147			8.6 [18.96]

** Spot face around port connections (can not be used in connection with OVR angular block)

If you require other port connections, valve combinations, valve settings and/or other displacements, please fill in the order form in the [Specification Table for Non Catalogue Numbers of LS Steering Units](#) and contact the Danfoss Sales Organization.

LS Steering Units OSPB, OSPC, OSPF, OSPD, OSPL
OSPL load sensing static non-reaction steering units

OSPL LS Static steering units have no valve functions.

OSPL LS in the three tables below have all strong neutral setting springs, see [Specification Table for Non Catalogue Numbers of LS Steering Units](#)

Steering unit	Code numbers			Weight kg [lb]
	Connections			
	European version for OLS G 1/2 G 1/4 - S ^{**})	US version for OLS 3/4-16 UNF - O ^{*)} * 7/16-20 UNF - O* + S ^{**})	US version for OLS and OVPL LS - port 7/16-20 UNF - O* + S ^{**})	
OSPL 520 LS	150-7169	150-7167	150-7168	8.1 [17.86]
OSPL 630 LS	150-7107	150-7164	150-7113	8.4 [18.52]
OSPL 800 LS	150-7108	150-7165	150-7114	8.8 [19.40]
OSPL 1000 LS	150-7110	150-7166	150-7115	10.0 [22.05]

^{*)} Spot face around port connection

^{*)} O-ring chamfer on port connections

OSPL load sensing dynamic non-reaction steering units

OSPL LS Dynamic steering units in the table below have no valve functions.

Steering unit	Code numbers	Weight kg [lb]
	Connections US version for OLS 3/4-16 UNF - O ^{*)} 7/16-20 UNF - O ^{*)} * + S ^{**})	
OSPL 520 LS	150-8243	8.1 [17.86]
OSPL 630 LS	150-8212	8.4 [18.52]
OSPL 800 LS	150-8213	8.8 [19.40]
OSPL 1000 LS	150-8214	10.0 [22.05]

^{*)} O-ring chamfer on port connections

^{**)} Spot face around port connection

OSPL LS Dynamic steering units in the table below incorporate all the following valve function:

- pilot pressure relief valve

Steering unit	Code numbers	Valve settings	Weight kg [lb]
	Connections European version for OLS and OVPL LS: G 1/4 - S ^{**})	Relief valve bar [psi]	
OSPL 520 LS	150-8244	170 [2465]	8.1 [17.86]
OSPL 1000 LS	150-8245		10.0 [22.05]

^{**)} Spot face around port connection

If you require other displacements or other valve setting, please fill in the order form in the [Specification Table for Non Catalogue Numbers of LS Steering Units](#) and contact the Danfoss Sales Organization.

OSPL 1200 LS Dynamic steering unit in the table below incorporate all the following valve function:

LS Steering Units OSPB, OSPC, OSPF, OSPD, OSPL

- shock valves
- suction valves

OSPL 1200 LS in the table below has strong neutral setting springs, see [Specification Table for Non Catalogue Numbers of LS Steering Units](#)

Steering unit	Code numbers	Valve settings	Weight kg [lb]
	Connections US version for OLS 3/4 - 16 UNF - O ^{*)} CF: 11/16 - 12 UN 7/16 - 20 UNF - O ^{*)} * + S ^{**)}	Shock valves bar [psi]	
OSPL 1200 LS	150-7175	280 [4061]	11 [24.25]

^{*)} O-ring chamfer on port connections

^{**)} Spot face around port connection

If you require other displacements or other valve setting, please fill in the order form in the [Specification Table for Non Catalogue Numbers of LS Steering Units](#) and contact the Danfoss Sales Organization.

OSPBX and OSPLX load sensing static steering units for OSQ static

OSPBX LS and OSPLX LS Static steering units in the table below have no valve functions.

OSPBX LS in the table below have all standard neutral setting springs, see [Specification Table for Non Catalogue Numbers of LS Steering Units](#)

OSPLX LS in the table below have all strong neutral setting springs, see [Specification Table for Non Catalogue Numbers of LS Steering Units](#)

Steering unit	Code numbers		Weight kg [lb]
	Connections		
	European version G 1/2 G 1/4 - S ^{**)}	US version 3/4-16 UNF - O ^{*)} 7/16-20 UNF - O ^{*)} * + S ^{**)}	
OSPBX 160 LS	150-1082	150-1078	5.6 [12.35]
OSPBX 200 LS	150-1083	150-1079	5.8 [12.79]
OSPBX 315 LS	150-1084	150-1080	6.2 [13.67]
OSPBX 400 LS	150-1085	150-1081	7.0 [15.43]
OSPLX 520 LS	150-7170	150-7173	8.1 [17.86]
OSPLX 630 LS	150-7171	150-7174	8.4 [18.52]
OSPLX 800 LS	150-7172	150-7155	8.8 [19.40]

^{**)} Spot face around port connection

^{*)} O-ring chamfer on port connections

OSPCX load sensing dynamic steering units for OSQ dynamic

OSPCX LS Dynamic steering unit in the table below incorporates the following valve function:

- pilot pressure relief valve

OSPCX LS in the table below has standard neutral setting springs, see [Specification Table for Non Catalogue Numbers of LS Steering Units](#)

Technical Information

OSPB/C/F/D/L LS Steering Units, OLS Priority Valves, OSQ Flow Amplifiers

LS Steering Units OSPB, OSPC, OSPF, OSPD, OSPL

Steering unit	Code numbers	Valve settings	Weight kg [lb]
	Connections European version for OLS and OVPL G ½ - S ^{**} G ¼ - S ^{**}	Relief valve bar [psi]	
OSPCX 160 LS	150-8188	200 [2900]	5,6 [12.35]

^{**}) Spot face around port connection

If you require other displacements or other valve setting, please fill in the order form in the [Specification Table for Non Catalogue Numbers of LS Steering Units](#) and contact the Danfoss Sales Organization.

Technical Information

OSPB/C/F/D/L LS Steering Units, OLS Priority Valves, OSQ Flow Amplifiers
LS Steering Units OSPB, OSPC, OSPF, OSPD, OSPL
Specification table for non catalogue numbers of LS Steering Units

Fill in your company data and place x's in the table where appropriate, then send to your Danfoss Sales Organization.

Your company	Name		Vehicle			Potential pcs/year				Completed by		Date		
Steering unit type	OSPC		OSPF		OSPD		OSPL		OSPLX		OSPCX			
Reaction type	LS (Non-reaction)						LSR (Reaction: only OSPC, OSPD)							
Load Sensing type	Static (Only OSPC, OSPL, OSPLX, OSPCX)						Dynamic							
DP, cm ³ /rev OSPC LS OSPF LS	40	50	60	70	80	100	125	160	185	200	230	250	315	400
DP, cm ³ /rev OSPC LSR	40	50	60	70	80	100	125	160	185	200				
DP, cm ³ /rev OSPD LS	60/185	60/220	60/260	70/195	70/230	70/270	70/385	100/200	100/260	100/300	125/285	125/325	125/440	
DP, cm ³ /rev OSPD LSR	60/185		60/220		70/195		70/230		100/200					
DP, cm ³ /rev OSPL, OSPLX	520		630		800		1000		1200 (only OSPL)					
DP, cm ³ /rev OSPCX	160		200		250		315		400					
Port threads OSPC, OSPF	G1/2		G1/2- S**		M18 × 1.5 - O* + S**		3/4-16 UNF - O*		for OLSA (only OSPC)					
Port threads OSPD	G1/2- S**				M18 × 1.5 - O* + S**				3/4-16 UNF - O*					
Port threads OSPL, OSPLX	G1/2		3/4-16 UNF - O*		For OPVL and without RV (LS = 7/16 - 20 UNF)				For OVPL and with RV (LS = G 1/4)					
Relief valve*** bar	70	80	90	100	110	120	140	170	190	200	210	no relief valve		
Shock valves bar	160		180		200		225		240		280		no shock valves	
Suction valves	Yes							No						
Check valve in LS	Yes (Only for OSPC dynamic and OSPD)							No (Only for OSPC, OSPF and OSPL)						
Neutral setting springs	Soft: 0.5 - 1.8 Nm in normal steering situations				Standard: 0.8 - 3 Nm in normal steering situations				Strong: 1.5 - 4 Nm in normal steering situations					
Unit black painted	Yes							No						

Technical Information

OSPB/C/F/D/L LS Steering Units, OLS Priority Valves, OSQ Flow Amplifiers
LS Steering Units OSPB, OSPC, OSPF, OSPD, OSPL

DP = Displacement, RV = Pilot pressure relief valve.

O*: O-ring chamfer on port connections.

S**: Spot face around port connections (can not be used in connection with OVR angular block).

RV*** see [Technical data](#) for limitation in maximum pressure depending on displacements.

Types not mentioned with port connections in the table above, are only available in the version(s) stated in the code number tables.

An alternative way to specify a variant is to state an existing code number and add the modifications, you would like to have implemented in the basic steering unit.

Code number of basic steering unit: _____

Requested modifications: _____

Technical data

Common data, refer to *General Steering Components Technical Information*, **BC00000096**.

Displacement, flow and pressure: OSPB LS, OSPC LS, OSPC LSR

OSPB LS, OSPC LS, OSPC LSR

Steering unit	Displacement cm ³ /rev [in ³ /rev]	Rated oil flow* l/min [US gal/min]	Max. pressure, bar (psi)		
			System pressure** P-T port pressure	T, absolute port pressure	L-T/R-T port pressure
OSPC 40 LS Static	40 [2.44]	4 [1.06]	140 [2030]	40 [580]	280 [4061]
OSPB/OSPC 50 LS Static	50 [3.05]	5 [1.32]			
OSPC 60 LS Static	60 [3.66]	6 [1.58]			
OSPC 70 LS Static	70 [4.27]	7 [1.85]	175 [2538]	175 [2538]	
OSPB/OSPC 80 LS Static	80 [4.88]	8 [2.11]			
OSPB/OSPC 100 LS Static	100 [6.10]	10 [2.64]			
OSPB/OSPC 125 LS Static	125 [7.63]	13 [3.43]			
OSPB/OSPC 160 LS Static	160 [9.76]	16 [4.23]			
OSPC 185 LS Static	185 [11.29]	19 [5.02]			
OSPB/OSPC 200 LS Static	200 [12.20]	20 [5.28]			
OSPC 230 LS Static	230 [14.03]	23 [6.07]			
OSPC 250 LS Static	250 [15.25]	25 [6.60]			
OSPB/OSPC 315 LS Static	315 [19.22]	32 [8.45]			
OSPB/OSPC 400 LS Static	400 [24.41]	40 [10.57]			

LS Steering Units OSPB, OSPC, OSPF, OSPD, OSPL
OSPB LS, OSPC LS, OSPCLSR (continued)

Steering unit	Displacement cm ³ /rev [in ³ /rev]	Rated oil flow* l/min [US gal/min]	Max. pressure, bar (psi)					
			System pressure** P-T port pressure	T, absolute port pressure	L-T/R-T port pressure			
OSPC 40 LS Dynamic	40 [2.44]	4 [1.06]	140 [2030]	40 [580]	280 [4061]			
OSPB/OSPC 50 LS Dynamic	50 [3.05]	5 [1.32]						
OSPC 60 LS Dynamic	60 [3.66]	6 [1.58]						
OSPC 70 LS Dynamic	70 [4.27]	7 [1.85]	175 [2538]	40 [580]	280 [4061]			
OSPB/OSPC 80 LS Dynamic	80 [4.88]	8 [2.11]						
OSPB/OSPC 100 LS Dynamic	100 [6.10]	10 [2.64]						
OSPB/OSPC 125 LS Dynamic	125 [7.63]	13 [3.43]	210 [3045]	40 [580]	280 [4061]			
OSPB/OSPC 160 LS Dynamic	160 [9.76]	16 [4.23]						
OSPC 185 LS Dynamic	185 [11.29]	19 [5.02]						
OSPB/OSPC 200 LS Dynamic	200 [12.20]	20 [5.28]						
OSPC 230 LS Dynamic	230 [14.03]	23 [6.07]						
OSPC 250 LS Dynamic	250 [15.25]	25 [6.60]						
OSPB/OSPC 315 LS Dynamic	315 [19.22]	32 [8.45]						
OSPB/OSPC 400 LS Dynamic	400 [24.41]	40 [10.57]						
OSPC 40 LSR Dynamic	40 [2.44]	4 [1.06]				140 [2030]	40 [580]	280 [4061]
OSPC 50 LSR Dynamic	50 [3.05]	5 [1.32]						
OSPC 60 LSR Dynamic	60 [3.66]	6 [1.58]						
OSPC 70 LSR Dynamic	70 [4.27]	7 [1.85]	175 [2538]	40 [580]	280 [4061]			
OSPC 80 LSR Dynamic	80 [4.88]	8 [2.11]						
SPC 100 LSR Dynamic	100 [6.10]	10 [2.64]						
OSPC 125 LSR Dynamic	125 [7.63]	13 [3.43]	210 [3045]	40 [580]	280 [4061]			
OSPC 160 LSR Dynamic	160 [9.76]	16 [4.23]						
OSPC 185 LSR Dynamic	185 [11.29]	19 [5.02]						
OSPC 200 LSR Dynamic	200 [12.20]	20 [5.28]						

* Rated flow at 100 rpm.

** Any OSPB/C LS Static can withstand 175 bar in maximum system pressure. However, OSPB/C with small gear wheel set and high pressure will have relatively high slippage values.

LS Steering Units OSPB, OSPC, OSPF, OSPD, OSPL
Displacement, flow and pressure: OSPF LS

Steering unit	Displacement cm ³ /rev [in ³ /rev]	Rated oil flow* l/min [US gal/min]	Max. pressure, bar (psi)		
			System pressure** P-T port pressure	T, absolute port pressure	L-T/R-T port pressure
OSPF 50 LS Dynamic	50 [3.05]	5 [1.32]	140 [2030]	40 [580]	280 [4061]
OSPF 60 LS Dynamic	60 [3.66]	6 [1.58]			
OSPF 70 LS Dynamic	70 [4.27]	7 [1.85]			
OSPF 80 LS Dynamic	80 [4.88]	8 [2.11]	175 [2538]		
OSPF 100 LS Dynamic	100 [6.10]	10 [2.64]			
OSPF 125 LS Dynamic	125 [7.63]	13 [3.43]			
OSPF 160 LS Dynamic	160 [9.76]	16 [4.23]	210 [3045]		
OSPF 185 LS Dynamic	185 [11.29]	19 [5.02]			
OSPF 200 LS Dynamic	200 [12.20]	20 [5.28]			
OSPF 230 LS Dynamic	230 [14.03]	23 [6.07]			
OSPF 250 LS Dynamic	250 [15.25]	25 [6.60]			
OSPF 315 LS Dynamic	315 [19.22]	32 [8.45]			
OSPF 400 LS Dynamic	400 [24.41]	40 [10.57]			

* Rated flow at 100 rpm.

** Any OSPB/C/F LS Dynamic can withstand 210 bar in max. system pressure. However OSPB/C/F w. small gear wheel set and high pressure will have relatively high slippage values.

Displacement, flow and pressure: OSPD LS

OSPD steering units in the table below are all Load Sensing Dynamic type.

Steering unit	Displacement manual steer mode cm ³ /rev [in ³ /rev]	Displacement normal steer mode cm ³ /rev [in ³ /rev]	Rated oil flow* l/min [US gal/min]	Max. pressure, bar (psi)		
				System Pressure P-T port pressure	T, absolute port pressure	L-T/R-T port pressure
OSPD 60/185 LS	60 [3.66]	185 [11.29]	19 [5.02]	210 [3045]	40 [580]	280 [4061]
OSPD 60/220 LS	60 [3.66]	220 [13.42]	22 [5.81]			
OSPD 60/260 LS	60 [3.66]	260 [15.87]	26 [6.87]			
OSPD 70/195 LS	70 [4.27]	195 [11.90]	20 [5.28]			
OSPD 70/230 LS	70 [4.27]	230 [14.03]	23 [6.07]			
OSPD 70/270 LS	70 [4.27]	270 [16.48]	27 [7.13]			
OSPD 70/385 LS	70 [4.27]	385 [23.49]	39 [10.30]			
OSPD 100/200 LS	100 [6.10]	200 [12.20]	20 [5.28]			
OSPD 100/260 LS	100 [6.10]	260 [15.87]	26 [6.87]			
OSPD 100/300 LS	100 [6.10]	300 [18.31]	30 [7.93]			
OSPD 125/285 LS	125 [7.63]	285 [17.39]	29 [7.66]			
OSPD 125/325 LS	125 [7.63]	325 [19.83]	33 [8.72]			
OSPD 125/440 LS	125 [7.63]	440 [26.85]	44 [11.62]			

LS Steering Units OSPB, OSPC, OSPF, OSPD, OSPL

Steering unit	Displacement manual steer mode cm ³ /rev [in ³ /rev]	Displacement normal steer mode cm ³ /rev [in ³ /rev]	Rated oil flow* l/min [US gal/min]	Max. pressure, bar (psi)		
				System Pressure P-T port pressure	T, absolute port pressure	L-T/R-T port pressure
OSPD 60/185 LSR	60 [3.66]	185 [11.29]	19 [5.02]	210 [3045]	40 [580]	280 [4061]
OSPD 60/220 LSR	60 [3.66]	220 [13.42]	22 [5.81]			
OSPD 70/195 LSR	70 [4.27]	195 [11.90]	20 [5.28]			
OSPD 100/200 LSR	100 [6.10]	200 [12.20]	20 [5.28]			

* Rated flow at 100 rpm.

Displacement, flow and pressure: OSPL LS, OSPBX LS, OSPCX LS, OSPLX LS

Steering unit	Displacement cm ³ /rev [in ³ /rev]	Rated oil flow* l/min [US gal/min]	Max. pressure, bar (psi)		
			System pressure P-T port pressure	T, absolute port pressure	L-R port pressure
OSPL 520 LS Static	520 [31.73]	52 [13.74]	240 [3480]	40 [580]	280 [4061]
OSPL 630 LS Static	630 [38.44]	63 [16.64]			
OSPL 800 LS Static	800 [48.82]	100 [26.40]			
OSPL 1000 LS Static	1000 [61.02]	100 [26.40]			
OSPL 520 LS Dynamic	520 [31.73]	52 [13.74]	240 [3080]	40 [580]	280 [4061]
OSPL 630 LS Dynamic	630 [38.44]	63 [16.64]			
OSPL 800 LS Dynamic	800 [48.82]	100 [26.40]			
OSPL 1000 LS Dynamic	1000 [61.02]	100 [26.40]			
OSPL 1200** Dynamic	1200 [73.22]	100 [26.40]			
OSPBX 160 LS Static	160 [9.76]	16 [4.23]	210 [3045]	40 [580]	280 [4061]
OSPBX 200 LS Static	200 [12.20]	20 [5.28]			
OSPBX 250 LS Static	250 [15.25]	25 [6.60]			
OSPBX 315 LS Static	315 [19.22]	32 [8.45]			
OSPBX 400 LS Static	400 [24.41]	40 [10.57]			
OSPCX 160 LS Dynamic	160 [9.76]	16 [4.23]	210 [3045]	40 [580]	280 [4061]
OSPCX 200 LS Dynamic	200 [12.20]	20 [5.28]			
OSPCX 250 LS Dynamic	250 [15.25]	25 [6.60]			
OSPCX 315 LS Dynamic	315 [19.22]	32 [8.45]			
OSPCX 400 LS Dynamic	400 [24.41]	40 [10.57]			
OSPLX 520 LS Static	520 [31.73]	52 [13.74]	240 [3480]	40 [580]	280 [4061]
OSPLX 630 LS Static	630 [38.44]	63 [16.64]			
OSPLX 800 LS Static	630 [38.44]	100 [26.40]			

* Rated flow at 100 rpm.

** OSPL 1200 max speed at 100l/min [26.4 US gal/min] 83 rpm.

LS Steering Units OSPB, OSPC, OSPF, OSPD, OSPL
Valve functions in OSPC, OSPF, OSPD and OSPL LS steering units
Pilot pressure relief valve; (P - T, Q_p) characteristic

The pilot pressure relief valve protects the steering unit against excessive pressure. The pilot pressure relief valve in the OSPC LS, OSPF LS, OSPD LS and OSPL LS steering unit together with the priority valve limit the maximum steering pressure P-T. The pilot pressure relief valve is set at an oil flow to the priority valve of 25 l/min [6.60 US gal/min].

For OSPC, OSPD and OSPL load sensing dynamic steering units, the setting values are valid at a dynamic flow of 0.6 l/min [0.16 US gal/min].

For OSPF load sensing dynamic steering units, the setting values are valid at a dynamic flow of 1.1 l/min [0.29 US gal/min].

Setting tolerance:

<= 170 bar [2465 psi]: rated value +5 bar [72.5 psi].

> 170 bar [2465 psi]: rated value +10 bar [145 psi].

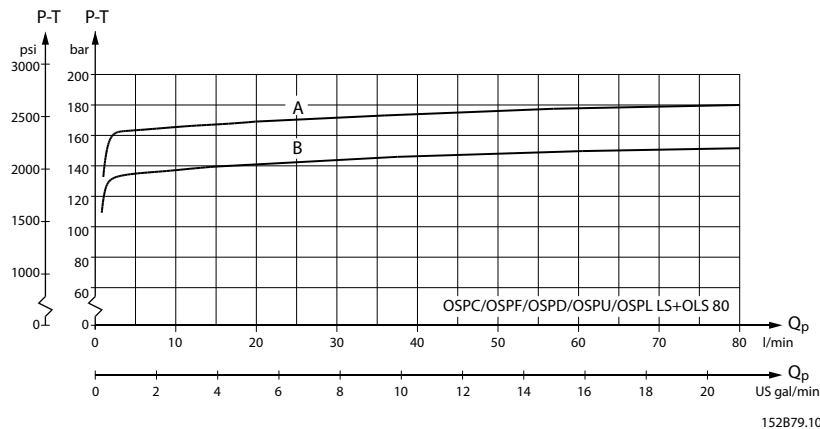

A = 170 + 5 bar [2465+ 73 psi]

- 0 - 0

B = 140 + 5 bar [2030 + 73 psi]

- 0 - 0

Shock valves

The shock valves protect the steering unit and reduce external forces on the steering cylinder by limiting the pressure difference from L to T and from R to T.

The shock valves are set at 3 l/min [0.792 US gal/min]

At higher flow pressure peaks may occur.

The shock valves are of the direct acting type, so they react very quickly.

Setting tolerance: rated value +20 bar [290 psi].

Suction valves

The suction valves allow oil suction to avoid cavitation in the steering cylinder. To provide correct suction, a back pressure valve must be fitted in the tank line from the steering unit.

Technical Information

OSP/C/F/D/L LS Steering Units, OLS Priority Valves, OSQ Flow Amplifiers
LS Steering Units OSPB, OSPC, OSPF, OSPD, OSPL

Generally Danfoss recommend a back pressure of 2 bar [29 psi], but on vehicles with strong self straightening tendencies and on articulated steered vehicles, we recommend 5-10 bar [72.5 - 145 psi]. For further advice, please contact the Danfoss Sales Organization.

A connection which incorporates a check valve must be established to allow oil flow to by-pass the back pressure valve (and filter) from the tank to steering unit. See diagram examples in sub catalogue "General Steering Components" page 37 - 39.

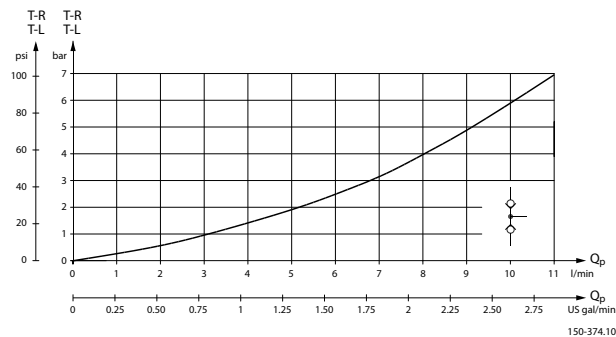
Check valves

The check valve in the P connection of the steering unit protects the driver against steering wheel jerks. The check valve prevents oil from flowing backwards into the pump line when steering against a high pressure on the cylinder side. The pressure drop across the check valve is indicated on the following graph, which assumes the use of port adapters with 11 mm [0.43 in] minimum bore.

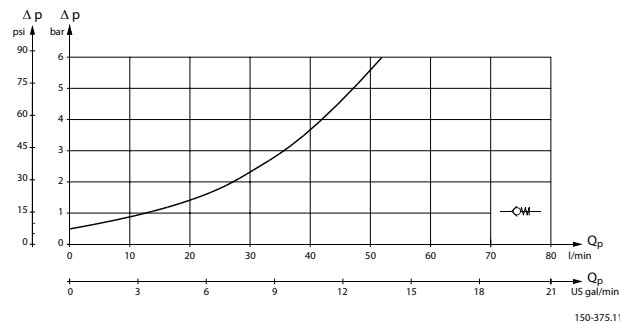

The check valve in the LS line of OSPC LS and OSPD LS dynamic steering units also protects the driver against steering wheel jerks. The check valve prevents oil from flowing backwards into the LS line to the priority valve when steering against a high pressure on the cylinder side.

In OSPF LS oil cannot flow backwards into the LS line, look in sub catalogue: "General Steering Components" page 26.

Technical Information

OSP/C/F/D/L LS Steering Units, OLS Priority Valves, OSQ Flow Amplifiers

LS Steering Units OSPB, OSPC, OSPF, OSPD, OSPL

Port thread versions for OSPB LS, OSPC LS/LSR, OSPF LS, OSPD LS/LSR, OSPL LS, OSPBX LS, OSPCX LS, OSPLX LS

A: G port w. spot face (LS in OSPB and OSPL with no valves)
K: DIN 3852-2 - G 1/4

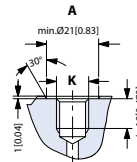

150-603.10-A

B: G port w. spot face (LS in OSPC/F/D/Q and OSPL with valves)
L: DIN 3852-2 - G 1/4

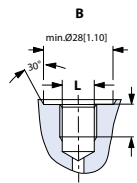

150-603.10-B

C: G ports (P, T, L, R)
M: DIN 3852-2 - G 1/2

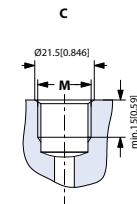

150-603.10-C

D: G ports w. spot face (P, T, L, R)
N: DIN 3852-2 - G 1/2

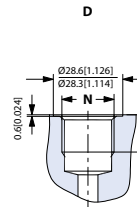

150-603.10-D

E: Metric port w. spot face and O-ring chamfer (LS)
O: ISO 6149-1 - M12 x 1.5

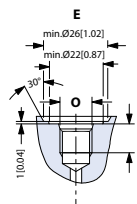

150-603.10-E

F: Metric ports w. spot face and O-ring chamfer (P, T, L, R)
P: ISO 6149-1 - M18 x 1.5

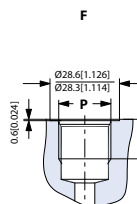

150-603.10-F

Technical Information

OSP/C/F/D/L LS Steering Units, OLS Priority Valves, OSQ Flow Amplifiers

LS Steering Units OSPB, OSPC, OSPF, OSPD, OSPL

G: UNF port w. O-ring chamfer (LS in OSPB and OSPL with no valves)

Q: ISO 11926-1 - 7/16-20UNF O-ring boss port

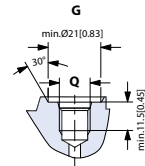

150-603.10-G

H: UNF ports w. O-ring chamfer (LS in OSPC/ F/D and OSPL with valves)

R: ISO 11926-1 - 7/16-20 UNF O-ring boss port

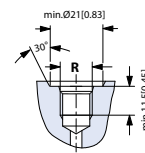

150-603.10-H

I: UNF ports w. O-ring chamfer (P, T, L, R)

S: ISO 11926-1 - 3/4-16UNF O-ring boss port

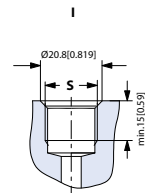

150-603.10-I

Technical Information

OSP/C/F/D/L LS Steering Units, OLS Priority Valves, OSQ Flow Amplifiers
LS Steering Units OSPB, OSPC, OSPF, OSPD, OSPL
Dimensions
OSPB LS for OLS, OSPBX LS for OSQ
Dimensions for OSPB LS for OLS, OSPBX LS for OSQ

Type	L ₁ mm [in]	L ₂ mm [in]
OSPB 50	126 [4.96]	6.5 [0.26]
OSPB 80	129 [5.08]	10.4 [0.41]
OSPB 100	132 [5.20]	13.0 [0.51]
OSPB 125	135 [5.31]	16.2 [0.64]
OSPB/OSPBX 160	140 [5.51]	20.8 [0.82]
OSPB/OSPBX 200	145 [5.71]	26.0 [1.02]
OSPB/OSPBX 250	151 [5.94]	32.5 [1.28]
OSPB/OSPBX 315	160 [6.30]	40.9 [1.61]
OSPB/OSPBX 400	171 [6.73]	52.0 [2.05]

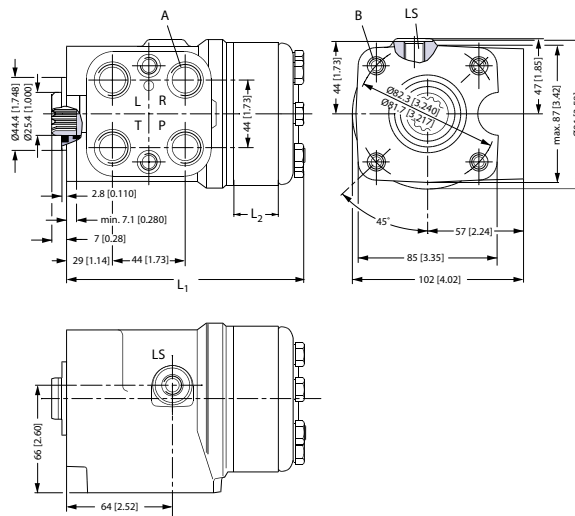
Dimensions for OSPB LS for OLS, OSPBX LS for OSQ

150-590.11

European version:

A: G 1/2; 15 mm [0.59 in] deep

B: M10 × 1.5, 16 mm [0.63 in] deep

LS: G ¼ with spot face, 11 mm [0.43 in] deep

US version:

A: 3/4 - 16 UNF O-ring boss; 15 mm [0.59 in] deep

B: 3/8 - 16 UNC, 16 mm [0.63 in] deep

LS: G 7/16 - 20 UNF O-ring boss, 11.5 mm [0.45 in] deep

Technical Information

OSP/C/F/D/L LS Steering Units, OLS Priority Valves, OSQ Flow Amplifiers

LS Steering Units OSPB, OSPC, OSPF, OSPD, OSPL

OSPC LS/LSR and OSPF LS for OLS, OSPCX LS for OSQ

Type	L ₁ mm [in]	L ₂ mm [in]
OSPC 40	126 [4.96]	6.5 [0.26]
OSPC/OSPF 50	126 [4.96]	6.5 [0.26]
OSPC/OSPF 60	128 [5.04]	9.1 [0.36]
OSPC/OSPF 70	128 [5.04]	9.1 [0.36]
OSPC/OSPF 80	129 [5.08]	10.4 [0.41]
OSPC/OSPF 100	132 [5.20]	13.0 [0.51]
OSPC/OSPF 125	135 [5.31]	16.2 [0.64]
OSPC/OSPF OSPCX 160	140 [5.51]	20.8 [0.82]
OSPC/OSPF 185	143 [5.63]	24.0 [0.94]
OSPC/OSPF OSPCX 200	145 [5.71]	26.0 [1.02]
OSPC/OSPF 230	149 [5.87]	29.9 [1.18]
OSPC/OSPF OSPCX 250	151 [5.94]	32.5 [1.28]
OSPC/OSPF OSPCX 315	160 [6.30]	40.9 [1.61]
OSPC/OSPF/OSPCX 400	171 [6.73]	52.0 [2.05]

Technical Information

OSP/C/F/D/L LS Steering Units, OLS Priority Valves, OSQ Flow Amplifiers

LS Steering Units OSPB, OSPC, OSPF, OSPD, OSPL

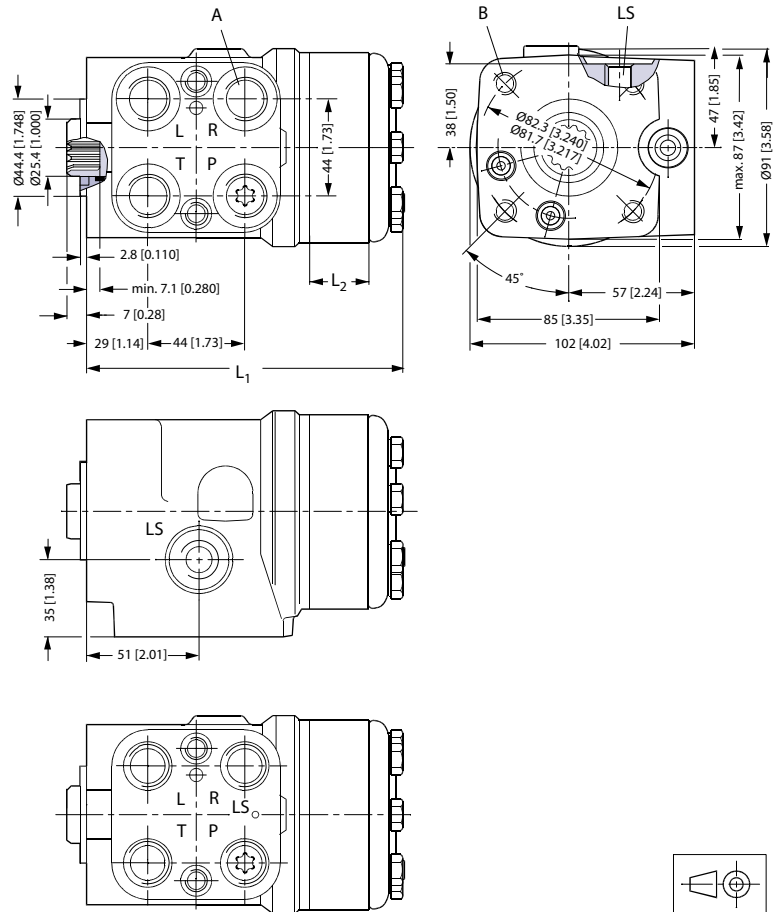

150-591.11

European version:

A: G 1/2 or G 1/2 w. spot face
or M18 x 1.5 ISO 6149,
15 mm [0.59 in] deep

B: M10 x 1.5, 16 mm [0.63 in] deep

LS: G 1/4 w. spot face
or M12 x 1.5 ISO 6149,
11.5 mm [0.45 in] deep

US version:

A: 3/4-16 UNF O-ring boss,
15 mm (0.59 in) deep

B: 3/8 - 16 UNC or M10 x 1.5, 16 mm [0.63 in] deep

LS: 7/16 - 20 UNF O-ring boss,
11.5 mm [0.45 in] deep

LS Steering Units OSPB, OSPC, OSPF, OSPD, OSPL
OSPD LS/LSR for OLS

Type	L ₁ mm [in]	L ₂ mm [in]	L ₃ mm [in]
OSPD 60/185	191 [7.52]	9.1 [0.36]	16.2 [0.64]
OSPD 60/220	195 [7.68]	9.1 [0.36]	20.8 [0.82]
OSPD 70/195	190 [7.48]	9.1 [0.36]	16.2 [0.65]
OSPD 70/230	195 [7.70]	9.1 [0.36]	20.8 [0.82]
OSPD 70/270	200 [7.87]	9.1 [0.36]	26.0 [1.02]
OSPD 70/385	215 [8.46]	9.1 [0.36]	40.9 [1.61]
OSPD 100/200	191 [7.52]	13.0 [0.51]	13.0 [0.51]
OSPD 100/260	199 [7.83]	13.0 [0.51]	20.8 [0.82]
OSPD 100/300	204 [8.03]	13.0 [0.51]	26.0 [1.02]
OSPD 125/285	202 [7.95]	16.2 [0.64]	20.8 [0.82]
OSPD 125/325	207 [8.15]	16.2 [0.64]	26.0 [1.02]
OSPD 125/440	222 [8.74]	16.2 [0.64]	40.9 [1.61]

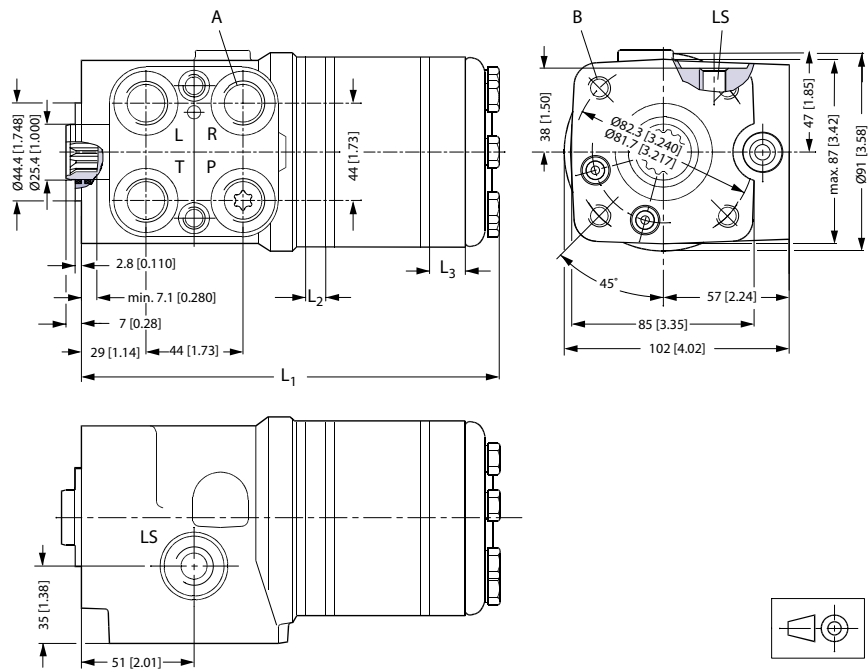
European version:

A: G 1/2 w. spot-face or M18 x 1.5 ISO 6149 15 mm [0.59 in] deep

B: M10 x 1.5, 16 mm [0.63 in] deep

LS: G 1/4 w. spot face or M 12 x 1.5 ISO 6149 11.5 mm [0.45 in] deep

US version:

A: 3/4 - 16 UNF O-ring boss; 15 mm [0.59 in] deep

B: M 10 x 1.5, 16 mm [0.63 in] deep,

LS: 7/16 - 20 UNF o-ring boss, 11.5 mm [0.45 in] deep

Technical Information

OSP/C/F/D/L LS Steering Units, OLS Priority Valves, OSQ Flow Amplifiers
LS Steering Units OSPB, OSPC, OSPF, OSPD, OSPL
OSPL LS for OLS and OSPLX LS for OSQ

Type	L ₁ mm [in]	L ₂ mm [in]
OSPL/OSPLX 520	197 [7.76]	67.8 [2.67]
OSPL/OSPLX 630	211 [8.31]	82.0 [3.23]
OSPL/OSPLX 800	233 [9.17]	104.0 [4.09]
OSPL 1000	263 [10.35]	134.0 [5.27]

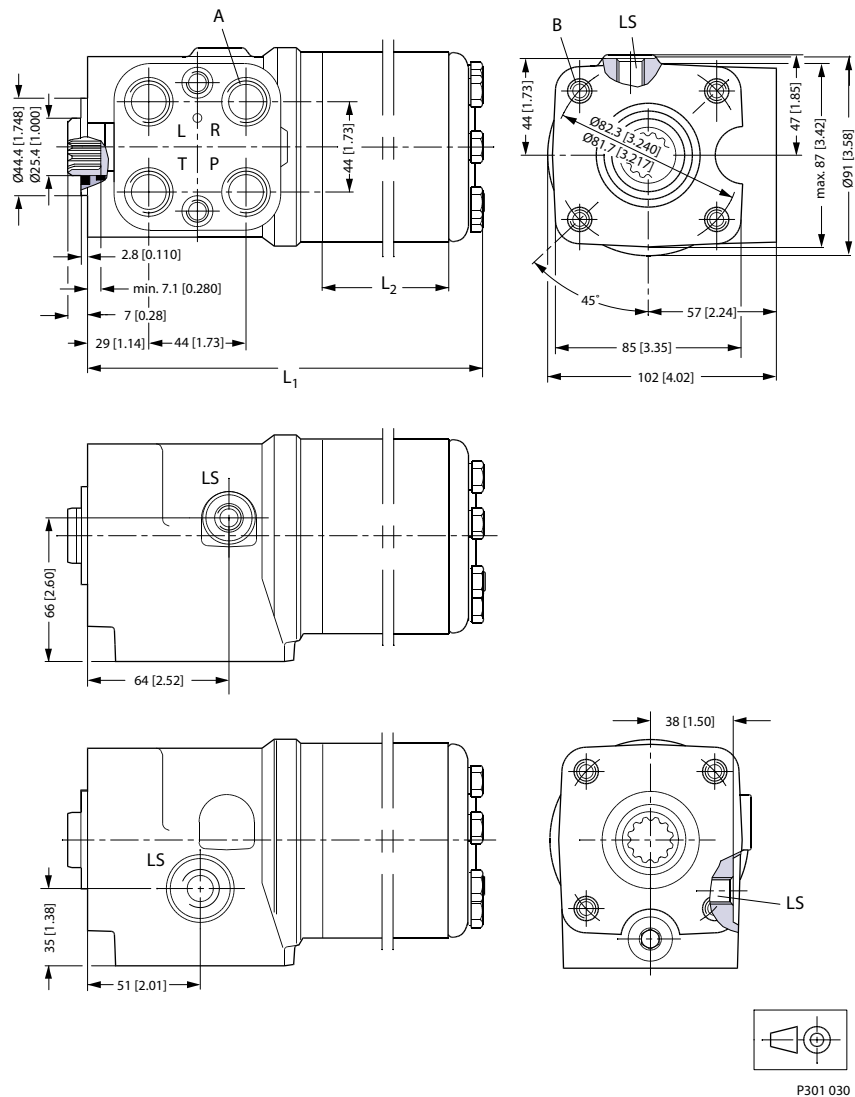
OSPL LS with pilot pressure relief valve:
European version:
US version:

Technical Information

OSPB/C/F/D/L LS Steering Units, OLS Priority Valves, OSQ Flow Amplifiers

LS Steering Units OSPB, OSPC, OSPF, OSPD, OSPL

A: G 1/2; 15 mm [0.59 in] deep

B: M10 x 1.5, 16 mm [0.63 in] deep

LS: G 1/4 w. spot face, 11.5 mm [0.45 in] deep

European version:

A: for OVPL

B: M10 x 1.5, 16 mm [0.63 in] deep

LS: G 1/4 w. spot face, 11.5 mm [0.45 in] deep

A: 3/4-16 UNF O-ring boss, 15 mm [0.59 in] deep or for OVPL

B: M10 x 1.5, 16 mm [0.63 in] deep

LS: 7/16-20 UNF O-ring boss, 11.5 mm [0.45 in] deep

Technical Information

OSP/C/F/D/L LS Steering Units, OLS Priority Valves, OSQ Flow Amplifiers
LS Steering Units OSPB, OSPC, OSPF, OSPD, OSPL
OSPL 1200 LS for OLS

Type	L ₁ mm [in]	L ₂ mm [in]	L ₃ mm [in]
OSPL 1200 LS	288 [10.34]	104 [4.09]	52 [2.05]

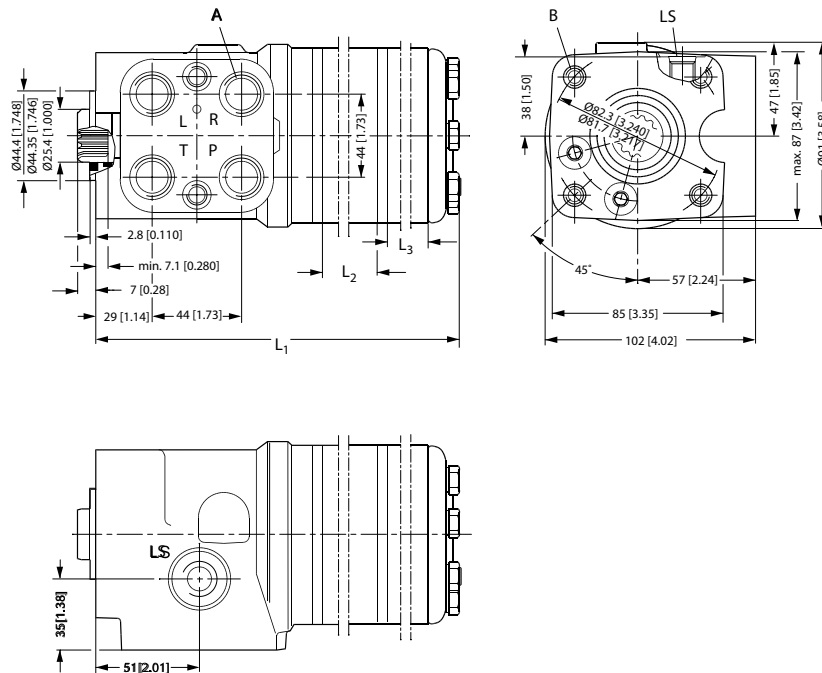

150-612.10

A: 3/4 - 16 UNF O-ring boss, 15 mm [0.59 in] deep

B: M10 x 1.5, 16 mm [0.63 in] deep

 LS: 7/16 - 20 UNF O-ring boss 11.5 mm [0.45 in] deep
 OSPL 1200 LS for OLS

Technical Information

OSP/C/F/D/L LS Steering Units, OLS Priority Valves, OSQ Flow Amplifiers

Valve Block OVPL

OVPL valve blocks can be flanged onto Danfoss steering units type OSPL, which are prepared for OVPL mounting.

Versions

OVPL valve blocks contain shock valves, suction valves, check valve and back-pressure valve. OVPL valve blocks are available with 4, 5 or 7 connections. OVPL with 7 connections, which means that 2 steering cylinders can be connected directly to the valve block.

OVPL, 7 ports

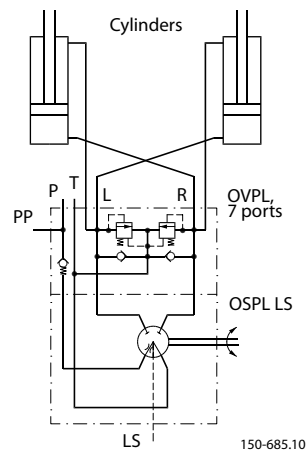

Technical Information

OSP/C/F/D/L LS Steering Units, OLS Priority Valves, OSQ Flow Amplifiers
Valve Block OVPL
Code numbers and weight

OVPL in the table below have all the following valve functions incorporated:

- Check valve in P-port
- Shock valves
- Suction valves

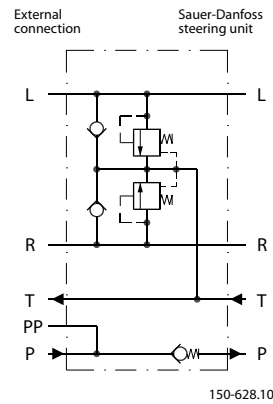
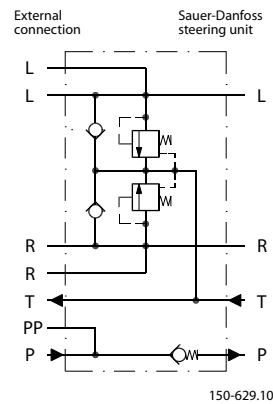
OVPL, 5 ports

OVPL, 7 ports

Valve block	Code numbers	Number of ports	Valve settings	Weight
	Connections European version P, T, L, R: G 1/2-S** PP: G 1/4-S**		Shock valve bar [psi]	kg [lb]
OVPL 24	152-1117	5	240 [3480]	2.0 [4.41]
OVPL 28	152-1114	5	280 [4061]	2.0 [4.41]
OVPL 28	152-1116	7	280 [4061]	2.0 [4.41]

** Spot face around port connections

OVPL in the table below has the following valve functions incorporated:

- Check valve in P-port
- Shock valves
- Suction valves
- Backpressure valve, with by-pass to reduce stand-by pressure in neutral position.

Technical Information

OSP/C/F/D/L LS Steering Units, OLS Priority Valves, OSQ Flow Amplifiers

Valve Block OVPL

OVPL, 5 ports and backpressure valve with by-pass

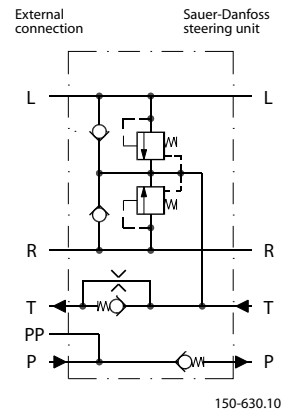

Valve block	Code numbers	Number of ports	Valve settings	Weight
	Connections European version P, T, L, R: G 1/2-S** PP: G 1/4-S**		Shock valve bar [psi]	kg [lb]
OVPL 24	152-1120	5	240 [3480]	2.0 [4.41]
OVPL 28	152-1130	5	280 [4061]	2.0 [4.41]

** Spot face around port connections

OVPL in the table below have all the following valve functions incorporated:

- Check valve in P-port
- Shock valves
- Suction valves
- Backpressure valve, without by-pass.

OVPL, 5 ports and backpressure valve

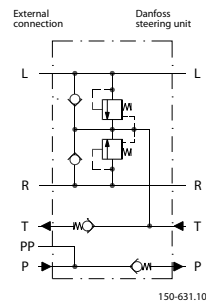

Technical Information

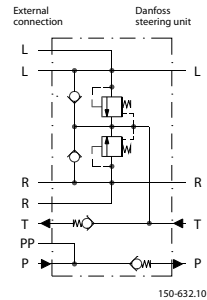
OSP/C/F/D/L LS Steering Units, OLS Priority Valves, OSQ Flow Amplifiers
Valve Block OVPL
OVPL, 7 ports and backpressure valve

Valve block	Code numbers	Number of ports	Valve settings	Weight
	Connections European version P, T, L, R: G 1/2 - S** PP: G 1/4 - S**		Shock valve bar [psi]	kg [lb]
OVPL 24	152-1132	5	240 [3480]	2.0 [4.41]
OVPL 28	152-1115	7	280 [4061]	2.0 [4.41]

** Spot face around port connections

OVPL in the table below has following valve functions incorporated:

- Check valve in P-port
- Shock valves
- Suction valves

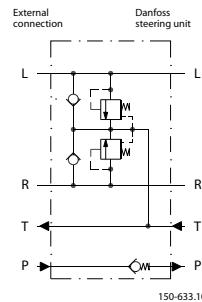
OVPL, 4 ports

Valve block	Code numbers	Number of ports	Valve settings	Weight
	Connections US version 3/4 - 16 UNF O* + S**		Shock valve bar [psi]	kg [lb]
OVPL 28	152-1133	4	280 [4061]	2.0 [4.41]

* O-ring chamfer on port connections

** Spot face around port connections

OVPL in the table below has the following valve functions incorporated:

- Check valve in P-port
- Shock valves
- Suction valves
- Backpressure valve with by-pass to reduce stand-by pressure in neutral position.

Technical Information

OSP/C/F/D/L LS Steering Units, OLS Priority Valves, OSQ Flow Amplifiers
Valve Block OVPL

OVPL, 4 ports and backpressure valve with by-pass

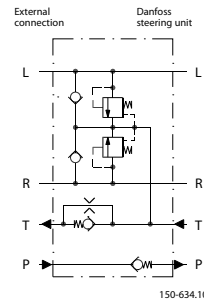

Valve block	Code numbers	Number of ports	Valve settings	Weight
	Connections US version 3/4 - 16 UNF O* + S**		Shock valve bar [psi]	kg [lb]
OVPL 28	152-1136	4	280 [4061]	2.0 [4.41]

* O-ring chamfer on port connections

** Spot face around port connections

Technical data
Common data

 Common data, refer to *General Steering Components Technical Information*, **BC00000096**.

Valve functions

The data below come from measurements on a representative sample of valve blocks from production.

 An oil with a viscosity of 21 mm²/s [SUS] at 50°C [122°F] was used during measuring.

Valve block	Max. Oil flow l/min [US gal/min]	Max. pressure on connections		
		P, PP bar [psi]	T bar [psi]	L, R bar [psi]
OVPL 24	100 [26.42]	190 [2756]	15 [218]	240 [3480]
OVPL 28	100 [26.42]	225 [3263]	15 [218]	280 [4061]

Shock valves

The shock valves protect the valve block and steering unit and limit maximum external forces on the steering cylinder. The shock valves in the valve block limit the maximum pressure drop from L to T and from R to T.

The shock valves are set at 10 l/min. [2.64 US gal/min].

The shock valves are of the direct acting type, so they react very quickly.

Setting tolerance: rated value +/- 10 bar [145 psi], ex. 240 [3480 psi] +/- 10 bar [145 psi].

Valve Block OVPL
Suction valves

The suction valves ensure oil suction to avoid cavitations in the steering cylinder. To provide correct suction, a back pressure valve must be fitted in the tank line from the steering unit.

The capacity of the suction valves can be increased by building in a back pressure in the valve block.

The curve below shows pressure drop across a suction valve

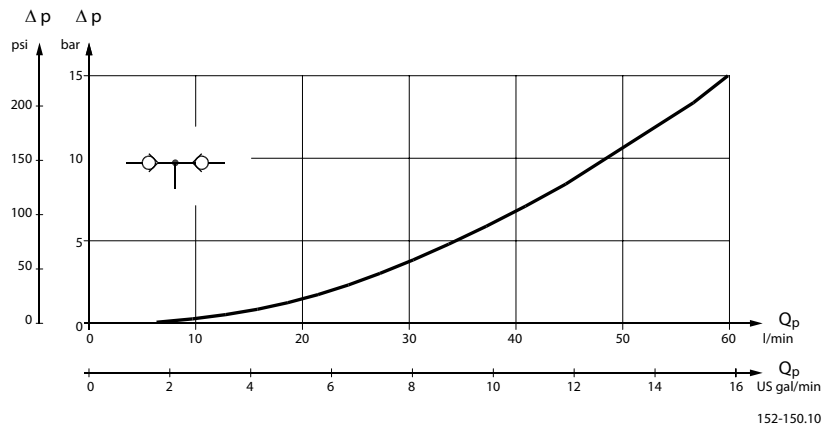
Check valve

The check valve protects the driver against steering wheel jerks. The check valve prevents oil from flowing backwards into the pump line when steering against a high pressure on the cylinder side.

The check valve is built into the P connection of the valve block.

The curve below shows pressure drop across the check valve in p-connection

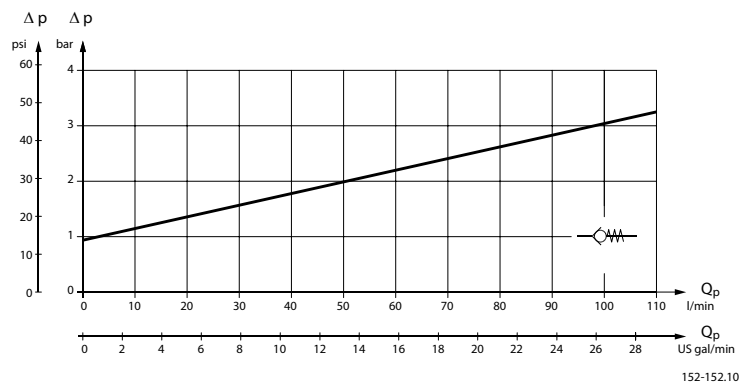
Backpressure valve

A backpressure valve increases the capacity of the suction valves.

The curve below shows pressure drop for backpressure valve without by-pass.

Technical Information

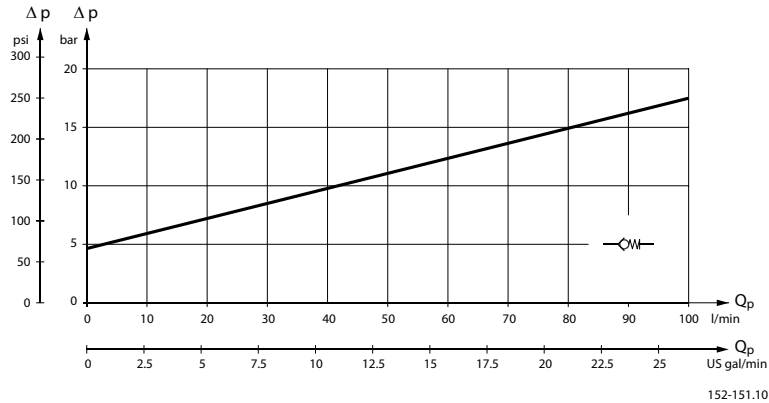
OSP/C/F/D/L LS Steering Units, OLS Priority Valves, OSQ Flow Amplifiers
Valve Block OVPL

The curve below shows pressure drop for backpressure valve with by-pass.

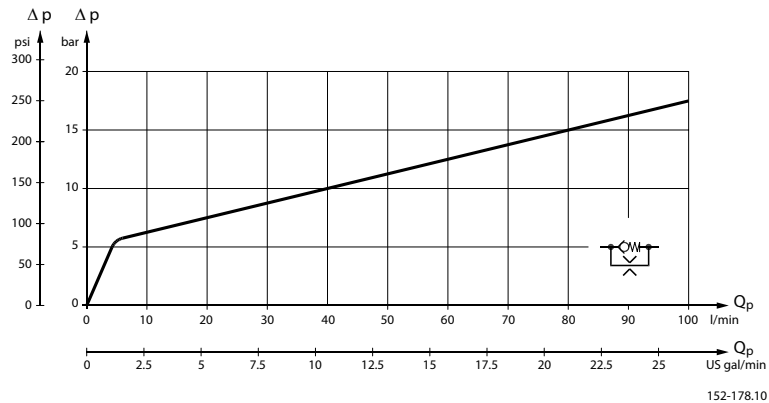
Installation

Connection P in the valve block must be placed over the connection P in the steering unit, so OVPL is provided with a positioning pin to fit the positioning hole in the steering unit.

The valve block is supplied inclusive of 2 mounting screws and 4 O-rings for building onto the steering unit.

Tightening torque $65 \pm 5 \text{ N}\cdot\text{m}$ [$575 \pm 44 \text{ lbf}\cdot\text{in}$]. It is only allowed to mount OVPL blocks on steering units with a flat port flange, no spot face is allowed.

Technical Information

OSP/C/F/D/L LS Steering Units, OLS Priority Valves, OSQ Flow Amplifiers

Valve Block OVPL

Dimensions

OVPL, 5 ports

European version:

P, T, L and R:

G 1/2 w. spot face,

15 mm [0.59 in] deep

PP: G 1/4, w. spot face,

11,5 mm [0.45 in] deep

X: 30,2 +0,2

Y: 21,3 +/- 0,2

OVPL, 4 ports (no PP)

US version:

P, T, L and R:

3/4-16 UNF O-ring boss

15 mm [0.59 in] deep

X: 30.2 +0.2

B: Positioning pin premounted in OVPL

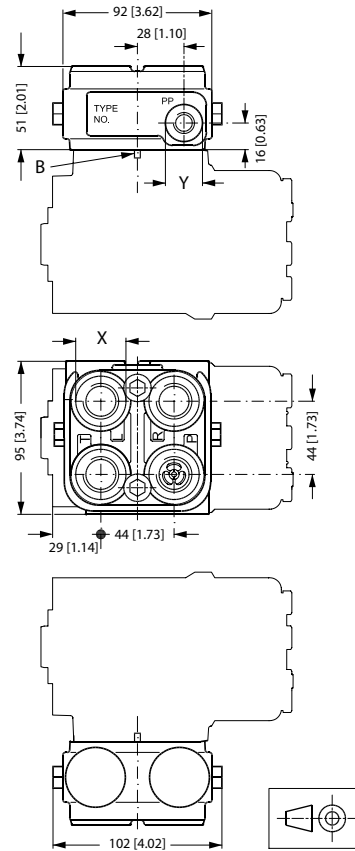

152-149.10

Technical Information

OSP/C/F/D/L LS Steering Units, OLS Priority Valves, OSQ Flow Amplifiers

Valve Block OVPL

OVPL, 7 ports

European version:

P, T, 2xL and 2xR:

G 1/2 w. spot face,

15 mm [0.59 in] deep

PP: G 1/4, w. spot face,

11.5 mm [0.45 in] deep

X: 30.2 +0.2

Y: 21.3 +/- 0.2

B: Positioning pin premounted in OVPL

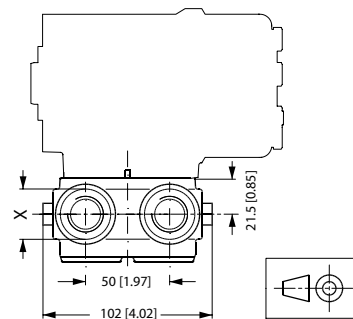
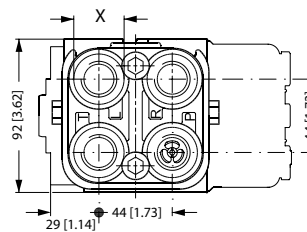
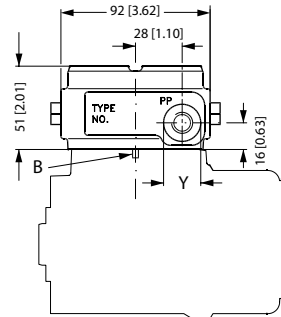

152-148.10

Technical Information

OSPB/C/F/D/L LS Steering Units, OLS Priority Valves, OSQ Flow Amplifiers
Angle Block OVR

OVR angle blocks are especially designed for applications in which pipes and/or hoses must run parallel with the steering column axis, and where space is limited.

The valve block can be flanged onto Danfoss steering unit OSPB, OSPC, OSPD, OSPF, OSPQ and OSPL, which have no spot face around the ports.

Use the angle block makes angle and swivel connections and pipe bends unnecessary.

The OVR connections are positioned away from the steering wheel. (see [Dimensions](#) on page 46)

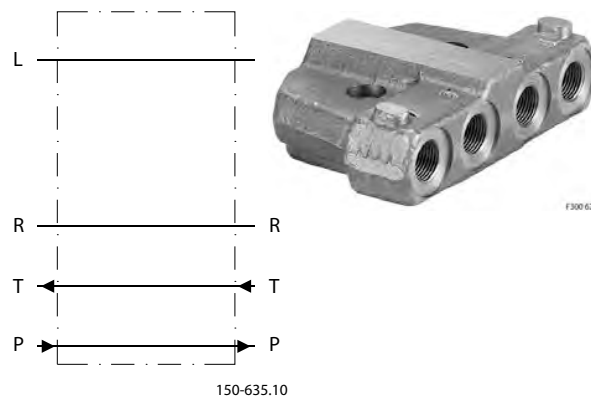
Version
OVR

Code numbers and weight

OVR in the table below has no valve functions incorporated.

Angle block	Code numbers	Weight
	Connections European version P, T, L, R: G 1/2 S**	kg [lb]
OVR	152-0201	2.0 [4.41]

S** : Spot face around port connections

Installation

The valve block is supplied inclusive of 2 mounting screws and 4 O-rings for building onto the steering unit.

Tightening torque 65 ± 5 N·m [575 ± 44.3 lbf·in]. OVR blocks may only be mounted on steering units with a flat port flange, (no spot facing).

For OVR blocks with other thread ore kind of valves mounted, please contact the Danfoss Sales organization.

Technical Information

OSP/C/F/D/L LS Steering Units, OLS Priority Valves, OSQ Flow Amplifiers

Angle Block OVR

Dimensions

OVR

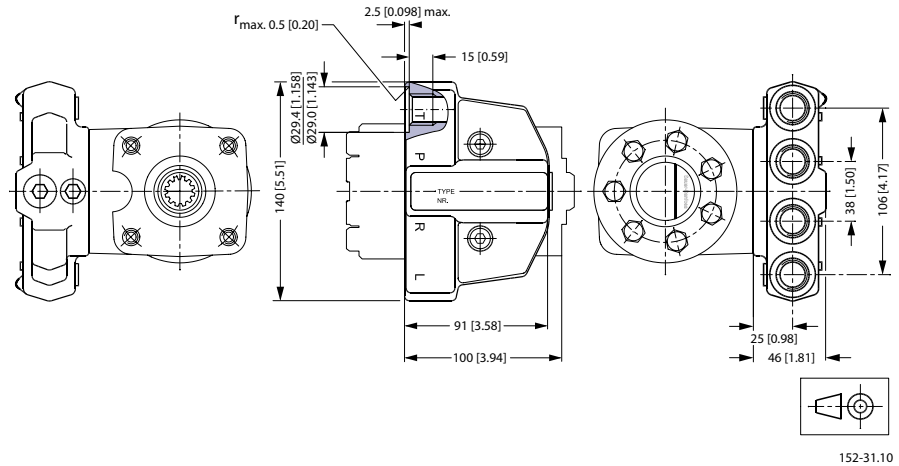

European version:

G 1/2, 15 mm [0.59 in] deep

P, T, L and R:

Technical Information

OSP/C/F/D/L LS Steering Units, OLS Priority Valves, OSQ Flow Amplifiers

Priority Valves OLSA and OLS

Versions

Danfoss priority valves are used in steering systems with load sensing steering units. In such systems steering always has first priority

Load sensing static priority valves

Load sensing static steering units require load sensing static priority valves. Load sensing static steering systems have no oil flow in the LS connection when the steering unit is in neutral position.

Load sensing dynamic priority valves

Load sensing dynamic steering units require load sensing dynamic priority valves. Load sensing dynamic steering systems have a constant oil flow in the LS connection from the priority valve to the steering unit even when the steering unit is in neutral position.

Ports:

P = pump,

CF = controlled flow (priority oil flow),

EF = excess flow,

L = left,

R = right,

T = tank,

LS = load sensing,

PP = pilot pressure

OLSA 40/80

The OLSA 40 and OLSA 80 "flange on" priority valves are used in load sensing steering systems, built onto OSPC LS (OLSA) steering units.

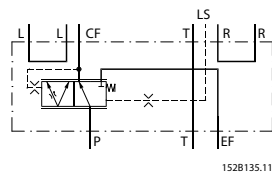

F300 625

OLSA static

152B135.11

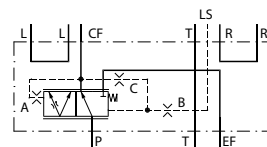
'OLSA dynamic

152B170.11

A: PP-damping orifice
 B: LS-orifice

Technical Information

OSP/C/F/D/L LS Steering Units, OLS Priority Valves, OSQ Flow Amplifiers
Priority Valves OLSA and OLS

C: Dynamic-orifice

The OLS 40, OLS 80 and OLS 120 "in line" priority valves are used in load sensing steering systems together with OSPB LS, OSPC LS, OSPF LS, OSPD LS, OSPU LS and OSPL LS steering units.

OLS 40/80

F300 624

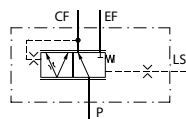

152B134.10

OLS static

OLS 120

F300 623

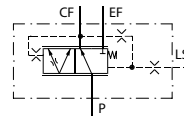

152B171.10

OLS dynamic

The OLS 160 "in line" priority valve is used in load sensing steering systems together with OSPB LS, OSPC LS, OSPF LS, OSPD LS, OSPU LS and OSPL LS steering units.

OLS 160

F300 622

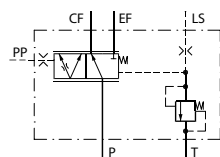

152B137.11

OLS static

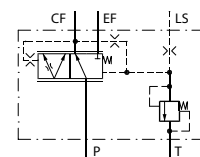

152B172.11

OLS dynamic

OLS 160 is also available without pilot pressure relief valve.

Priority Valves OLSA and OLS

The priority valve OLSP 80 is to be used in connection with e.g. Danfoss gear pumps type SNP and steering units type OSPB LS, OSPC LS, OSPF LS, OSPD LS and OSPU LS in load sensing steering systems, where maximum oil flow does not exceed 80 l/min [21.7 US gal/min].

OLSP 80 priority valves are to be flanged on gear pumps with outlet ports square flange type 35 (35 mm pitch diameter of 4x M6 bolt holes for fixing the priority valve on pump).

320 l/min [84.5 USgal/min].

OLS 320



F301 470

EHPS steering valve has built in priority valve, but for max. pump flow 120 l/min [31.7 USgal/min] In systems with EHPS and pump flow between 120 l/min [31.7 USgal/min] and 320 l/min [84.5 USgal/min] a combination of EHPS and OLS 320 gives a good compact solution to reduce hosing and installation cost compared with stand alone components. For further details of this OLS 320: look in *EHPS Steering Valve with PVE Electrical Actuation Module and OSPCX CN Steering Wheel Technical Information*, **BC00000101**.

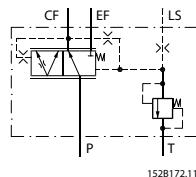

1528172.11



F301 471

System sizing

The steering system pump is sized so that satisfactory performance is achieved for both steering and working hydraulics - even at idle.

Before selecting a priority valve, consider

Priority Valves OLSA and OLS

- the type of steering unit (LS static, LS dynamic or OSPF LS dynamic)
- the displacement of the steering unit
- the pump flow
- the application's requirement for energy optimization, initial steering response time and stability, as these all govern the selection for control spring pressure
- whether the priority valve should have internal PP (Pilot Pressure) or external PP-connection depends on the pressure drop in the pump line between the priority valve's CF-port (Controlled Flow) and the steering unit's P-port. With normal hose and tube dimensions and less than 5 m distance between priority valve and steering unit, the immediate choice is normally a priority valve with internal PP.

The following survey lists the code numbers of the priority valves that are the most frequently used in connection with the above Danfoss steering unit types. All priority valves in the code number tables, except OLS 160 static, have internal PP connection. OLS 160 static in the code number table all have external PP connection.

Code numbers and weights
OLS/OLSA static priority valves for load sensing static steering units
OLSA 40 static and OLSA 80 static

Priority valve	Code Numbers		Control spring pressure bar [psi]	Weight kg [lb]
	Connections			
	European version T, R, L: G 3/8 P, EF: G 1/2	US version T, R, L: 9/16 - 18 UNF P, EF: 7/8 - 14 UNF		
OLSA 40	152B0001	-	4 [58]	2.1 [4.63]
OLSA 40	152B0002	152B0122	7 [101.5]	2.1 [4.63]
OLSA 40	152B0003	152B0124	10 [145]	2.1 [4.63]
OLSA 80	152B0016	152B0019	4 [58]	2.1 [4.63]
OLSA 80	152B0017	152B0020	7 [101.5]	2.1 [4.63]
OLSA80	152B0015	152B0125	10 [145]	2.1 [4.63]

OLS 40 static and OLS 80 static

Priority valve	Code Numbers		Control spring pressure bar [psi]	Weight kg [lb]
	Connections			
	European version LS: G 1/4 P, EF, CF: G 1/2	US version LS: 7/16 - 20 UNF CF: 3/4 - 16 UNF P, EF: 7/8 - 14 UNF		
OLS 40	152B0231	152B0237	4 [58]	1.0 [2.2]
OLS 40	152B0232	152B0238	7 [101.5]	1.0 [2.2]
OLS 40	152B0233	152B0253	10 [145]	1.0 [2.2]
OLS 80	152B0261	152B0267	4 [58]	1.0 [2.2]
OLS 80	152B0262	152B0268	7 [101.5]	1.0 [2.2]
OLS 80	152B0263	152B0280	10 [145]	1.0 [2.2]

Priority Valves OLSA and OLS
OLS/OLSA static priority valves for load sensing static steering units
OLS 120 static

Priority valve	Code Numbers		Control spring pressure bar [psi]	Weight kg [lb]
	Connections			
	European version LS: G 1/4 CF: G 1/2 P, EF: G 3/4	US version LS: 7/16 -20 UNF CF: 3/4 - 16 UNF P, EF: 1 1/16 - 12 UNF		
OLS 120	152B2232	152B2238	7 [101.5]	2.1 [4.63]
OLS 120	152B2233	152B2239	10 [145]	2.1 [4.63]

OLS 160 static

Priority valve	Code numbers		Control spring pressure bar [psi]	Pilot pressure relief valve bar [psi]	Weight kg [lb]
	Connections				
	European version LS, PP, T: G 1/4 CF: G 1/2 P, EF: G 3/4	US version LS, PP, T: 7/16 -20 UNF CF: 3/4 - 16 UNF P, EF: 1 1/16 - 12 UNF			
OLS 160	152B1005	152B1085	7 [101.5]	170 [2465]	4.4 [9.7]
OLS 160	152B1006	152B1086	10 [145]	170 [2465]	4.4 [9.7]

OLS/OLSA dynamic priority valves for load sensing dynamic steering units
OLSA 40 dynamic and OLSA 80 dynamic for OSPC LS dynamic

Priority valve	Code numbers		Control spring pressure bar [psi]	Weight kg [lb]
	Connections			
	European version T,R,L: G 3/8 P/EF: G 1/2	US version T,R,L: 9/16 - 18 UNF P/EF: 7/8 - 14 UNF		
OLSA 40	152B8001	-	4 [58]	2.1 [4.63]
OLSA 40	152B8041	152B8042	7 [101.5]	2.1 [4.63]
OLSA 40	152B8046	152B8043	10 [145]	2.1 [4.63]
OLSA 80	152B8047	-	4 [58]	2.1 [4.63]
OLSA 80	152B8048	152B8044	7 [101.5]	2.1 [4.63]
OLSA 80	152B8049	152B8045	10 [145]	2.1 [4.63]

Priority Valves OLSA and OLS
OLS/OLSA dynamic priority valves for load sensing dynamic steering units
OLS 40 dynamic and OLS 80 dynamic for OSPB, OSPC, OSPD and OSPL LS dynamic

Priority valve	Code numbers		Control spring pressure bar [psi]	Weight kg [lb]
	Connections			
	European version LS: G 1/4 P, EF, CF: G 1/2	US version LS: 7/16 - 20 UNF CF: 3/4 - 16 UNF P, EF: 7/8 - 14 UNF		
OLS 40	152B8231	-	4 [58]	1.0 [2.20]
OLS 40	152B8232	152B8253	7 [101.5]	1.0 [2.20]
OLS 40	152B8233	152B8254	10 [145]	1.0 [2.20]
OLS 80	152B8261	-	4 [58]	1.0 [2.20]
OLS 80	152B8256	152B8268	7 [101.5]	1.0 [2.20]
OLS 80	152B8257	152B8260	10 [145]	1.0 [2.20]

OLS 80 dynamic with low pressure drop (P-EF) spool for OSPB, OSPC, OSPD and OSPL LS dynamic

Priority valve	Code numbers		Control spring pressure bar [psi]	Weight kg [lb]
	Connections			
	European version LS: G 1/4 P, EF, CF: G 1/2			
OLS 80	152B8259		7 [101.5]	1.0 [2.20]

OLS 120 dynamic for OSPB, OSPC, OSPD and OSPL LS dynamic

Priority valve	Code numbers		Control spring pressure bar [psi]	Weight kg [lb]
	Connections			
	European version LS: G 1/4 CF: G 1/2 P, EF: G 3/4	US version LS: 7/16 - 20 UNF CF: 3/4 - 16 UNF P, EF: 1 1/16 - 12 UNF		
OLS 120	152B8132	152B8143	7 [101.5]	2.1 [4.63]
OLS 120	152B8133	152B8144	10 [145]	2.1 [4.63]

OLS 160 dynamic for OSPB, OSPC, OSPD and OSPL LS dynamic

Priority valve	Code numbers		Control spring pressure bar [psi]	Pilot pressure relief valve bar [psi]	Weight kg [lb]
	Connections				
	European version LS, T: G 1/4 CF: G 1/2 P, EF: G 3/4	US version LS, T: 1/16 - 20 UNF CF: 3/4 - 16 UNF P, EF: 1 1/16 - 12 UNF			
OLS 160	152B8159	152B8154	7 [101.5]	170 [2465]	4.4 [9.7]
OLS 160	152B8160	152B8155	10 [145]	170 [2465]	4.4 [9.7]
OLS 160	152B8105	-	12 [174]	170 [2465]	4.4 [9.7]
OLS 160	152B8161	152B8156	7 [101.5]	210 [3045]	4.4 [9.7]
OLS 160	152B8162	152B8157	10 [145]	210 [3045]	4.4 [9.7]

Priority Valves OLSA and OLS
OLS dynamic priority valves for OSPF LS and OSPU LS dynamic steering units
OLS 40 dynamic and OLS 80 dynamic

Priority valve	Code numbers	Control spring pressure bar [psi]	Weight kg [lb]
	Connections		
	European version LS: G 1/4 P, EF, CF: G 1/2		
OLS 40	152B8031	10 [145]	1.0 [2.20]
OLS 80	152B8258	7 [101.5]	1.0 [2.20]

OLS 120 dynamic

Priority valve	Code numbers	Control spring pressure bar [psi]	Weight kg [lb]
	Connections		
	European version LS: G 1/4, CF: G 1/2 P, EF, CF: G 3/4		
OLS 120	152B8147	7 [101.5]	2.1 [4.63]

OLS 160 dynamic

Priority valve	Code numbers	Control spring pressure bar [psi]	Pilot pressure relief valve bar [psi]	Weight kg [lb]
	Connections			
	European version LS: G 1/4, CF: G 1/2 P, EF, CF: G 3/4			
OLS 160	152B8158	7 [101.5]	none	4.4 [9.7]
OLS 160	152B8113	10 [145]	none	4.4 [9.7]

OLSP static and dynamic

Priority valve	Code numbers	Control spring pressure bar [psi]	Weight kg [lb]
	Connections		
	European version LS: G 3/8 CF: G 3/8 EF: G 1/2		
OLSP 80 static	152B5002	4 [58]	1.0 [2.2]
OLSP 80 dynamic	152B5200	7 [101.5]	1.0 [2.2]
OLSP 80 dynamic for OSPF and OSPU	152B5201	7 [101.5]	1.0 [2.2]

Priority Valves OLSA and OLS

OLS 320 dynamic in-line/stand alone with pilot pressure relief valve, black painted

Priority valve	Code numbers	Control spring pressure bar [psi]	Pilot pressure relief valve bar [psi]	Weight kg [lb]
	Connections			
	European version LS, T: G $\frac{3}{4}$ CF: G $\frac{1}{2}$ P, EF: G 1			
OLS 320	11006593	7 [101.5]	170 [2465]	5.9 [13.0]

OLS 320 dynamic in-line/stand alone without pilot pressure relief valve, black painted

Priority valve	Code numbers	Control spring pressure bar [psi]	Weight kg [lb]
	Connections		
	US version LS: 7/16 - 20 UNF CF: 11/16 - 12 UN P, EF: 15/16 - 12 UN		
OLS 320	11007475	10 [145]	5.9 [13.0]

OLS 320 for EHPS: look in *EHPS Steering Valve with PVE Electrical Actuation Module and OSP/CX CN Steering Wheel Technical Information*, **BC00000101**

If you require other port connections, other control spring pressure and/or other PP connection, go to the survey under *System sizing* on page 49, and tick off the desired specifications, then consult the Danfoss Sales Organization.

Technical Information

OSP/C/F/D/L LS Steering Units, OLS Priority Valves, OSQ Flow Amplifiers
Priority Valves OLSA and OLS
Specification table for non catalogue numbers of Danfoss Priority Valves

Your company	Name	Vehicle	Potential, pcs/year	Completed by	Date							
Your application	Pump flow to OLS/OLSA at idle, l/min [USgal/min]			Pump flow to OLS/OLSA at max. engine speed, l/min [USgal/min]								
Priority valve type	OLSA 40	OLSA 80	OLS 40	OLS 80	OLS 120	OLS 160	OLSP 80	OLS 320 in-line				
Load sensing type	Static		Dynamic		Dynamic for OSPF and OSPU steering unit							
Spool type	Standard		Low pressure drop, P-EF (only OLS/OLSA 80 dynamic)			No CF cut-off (only for OLS 320 for flanging on EHPS)						
Control spring, bar	4 (only OLS 80, 120, 160, OLSP 80)		5.5 (only OLS/OLSA 40/80)		7		10		12 (only OLS 160) 16 (only OLS 160)			
PP connection	Internal				External (not OLSP)							
Ports, OLSA	G: P, EF: G $\frac{1}{2}$ - S** T, L, R: G $\frac{3}{8}$ - S**		Metric 1: P, EF, T, L, R: M18 • 1.5 - O*** + S**		Metric 2: P, EF: M22 • 1.5 - O*** + S** T, L, R: M18 • 1.5 - O*** + S**		UNF: P, EF: 7/8 - 14 UNF - O*** T, L, R: 9/16 - 18 UNF - O***					
Ports, OLS 40/80	P, EF, CF: G $\frac{1}{2}$ - S** G: LS: G $\frac{1}{2}$ - S**		P, EF: M22 • 1.5 - O*** + S** Metric: CF: M18 • 1.5 - O*** + S** LS: M12 • 1.5 - O*** + S**		P, EF: 7/8 - 14 UNF - O*** UNF: CF: 3/4 - 16 UNF - O*** LS: 7/16 - 20 UNF - O***							
Ports, OLS 120	P, EF: G $\frac{3}{4}$ - S** G: CF: G $\frac{1}{2}$ - S** LS, PP: G $\frac{1}{4}$ - S**		P, EF: M27 • 2 - O*** + S** Metric: CF: M18 • 1.5 - O*** + S** LS: M12 • 1.5 - O*** + S**		P, EF: 11/16 - 14 UNF - O*** UNF: CF: 3/4 - 16 UNF - O*** LS: 7/16 - 20 UNF - O***							
Ports, OLS 160	P, EF: G $\frac{3}{4}$ - S** G 1: CF: G $\frac{1}{2}$ - S** LS, PP, T: G $\frac{1}{4}$ - S**		P, EF: G1 - S** G 2: CF: G $\frac{3}{4}$ - S** LS, PP, T: G $\frac{1}{4}$ - S**		P, EF: 11/16 - 12 UN - O*** UNF 1: CF: 3/4 - 16 UNF - O*** LS, PP, T: 7/16 - 20 UNF - O***		P, EF: 15/16 - 12 UN - O*** UNF 2: CF: 7/8 - 14 UNF - O*** LS, PP, T: 7/16 - 20 UNF - O***					
Ports, OLSP 80 (P: square flange 35)	EF: G $\frac{1}{2}$ - S** G: CF: G $\frac{3}{8}$ - S** LS: G $\frac{1}{4}$ - S**		EF: M22 • 1.5 - S** Metric: CF: M18 • 1.5 - S** LS: M12 • 1.5 - S**		EF: 7/8 - 14 UNF - O*** UNF: CF: 3/4 - 16 UNF - O*** LS: 7/16 - 20 UNF - O***							
Ports, OLS 320 in-line	P, EF: G1 - S** G: CF: G $\frac{1}{2}$ - S** LS, PP: G $\frac{1}{4}$ - S**		P, EF: 1 5/16 - 12 UN - O*** UNF 1: CF: 3/4 - 16 UNF - O*** LS, PP, T: 7/16 - 20 UNF - O***		P, EF: 1 5/16 - 12 UN - O*** UNF 2: CF: 1 1/16 - 12 UNF - O*** LS, PP, T: 7/16 - 20 UNF - O***							
RV-bar OLS 160 OLS 320	80	90	100	110	120	140	170	190	200	210	Other settings	No relief valve
Unit black painted	Yes									No		

Ports: PP-port only exists when external PP connection is used. T-port only exists for OLS 160 and OLS 320 with integrated pilot pressure relief valve (RV)

O*: O-ring chamfer on port connections

Technical Information

OSPB/C/F/D/L LS Steering Units, OLS Priority Valves, OSQ Flow Amplifiers
Priority Valves OLSA and OLS

S**: Spot face around port connections

An alternative way to specify a variant is to state an existing code number and add the modifications, you would like to have implemented in the basic steering unit.

Code number of basic steering unit: _____

Requested modifications: _____

Technical data
Max. pressure on connections

Priority valve	Rated flow to P-connection l/min [US gal/min]	Max. pressure on connections					
		P, EF	CF	L, R	LS	T	PP
		bar [psi]	bar [psi]	bar [psi]	bar [psi]	bar [psi]	bar [psi]
OLSA 40	40 [10.57]	250 [3625]	240 [3480]	280 [4061]	240 [3480]	20 [290]	--
OLSA 80	80 [21.13]	250 [3625]	240 [3480]	280 [4061]	240 [3480]	20 [290]	--
OLS 40	40 [10.57]	250 [3625]	240 [3480]	--	240 [3480]	--	210 [3045]
OLS 80	80 [21.13]	250 [3625]	240 [3480]	--	240 [3480]	--	210 [3045]
OLS 120	120 [31.70]	250 [3625]	240 [3480]	--	240 [3480]	--	210 [3045]
OLS 160	160 [42.27]	350 [5076]	240 [3480]	--	240 [3480]	15 [217]	210 [3045]
OLSP 80	80 [21.13]	280 [4061]	240 [3480]	--	240 [3480]	--	--
OLS 320	320 [84.54]	300 [4351]	280 [4061]	--	280 [4061]	40 [580]	280 [4061]

Pressure drop in priority valves

 This data comes from measurements on a representative sample of priority valves from production. Oil with viscosity of 21 mm²/s at 50 °C [102 SUS at 122 °F] was used during measuring. Measurement made when pressure on the LS connection is zero (steering unit in neutral position). The minimum curves apply when the pressure on the EF connection is higher than the actual control spring pressure. The curves for control spring pressure of 4, 7, 10 or 12 bar [58, 101, 145 or 174 psi] apply when pressure on the EF connection is zero.

Pressure drop P-EF for static priority valves

OLSA/OLS 40

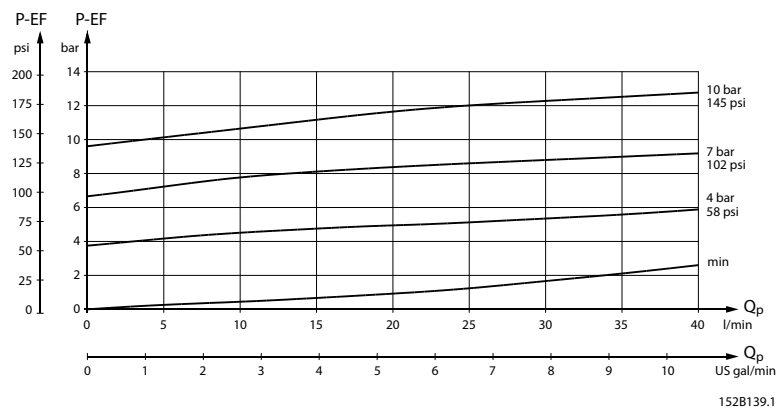

Technical Information

OSP/C/F/D/L LS Steering Units, OLS Priority Valves, OSQ Flow Amplifiers

Priority Valves OLSA and OLS

OLSA/OLS 80

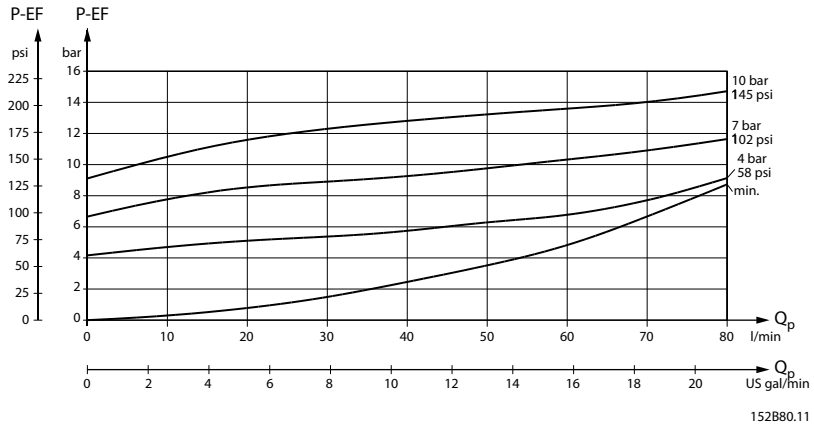

OLS 120

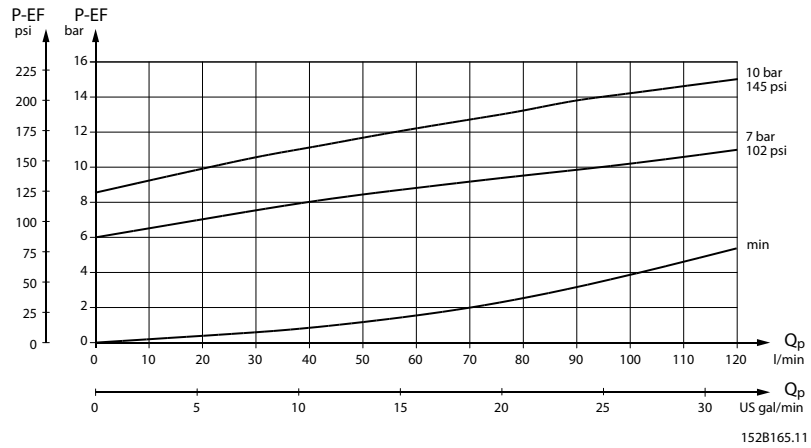

Technical Information

OSP/C/F/D/L LS Steering Units, OLS Priority Valves, OSQ Flow Amplifiers

Priority Valves OLSA and OLS

OLS 160

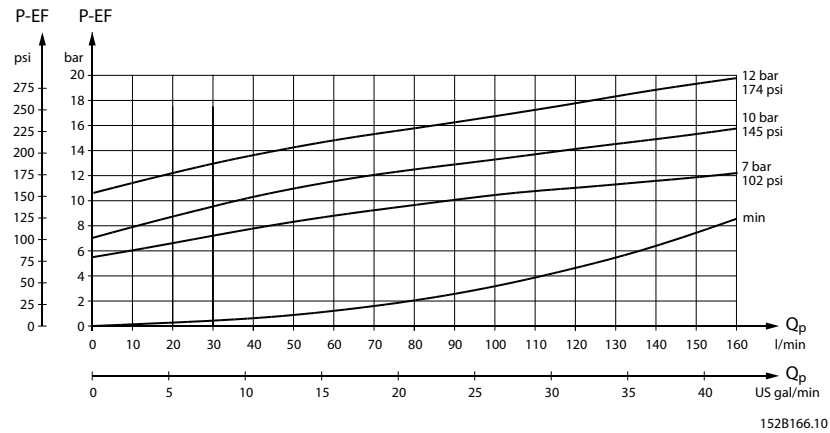

Pressure drop P-EF for dynamic priority valves

OLSA/OLS 40

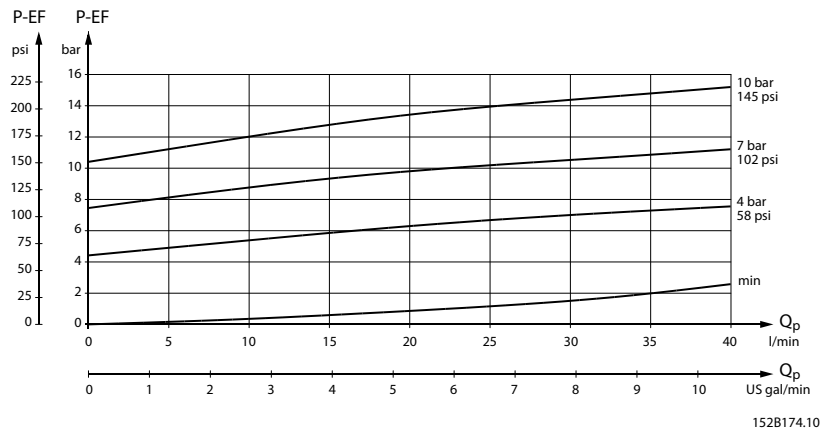

Technical Information

OSPB/C/F/D/L LS Steering Units, OLS Priority Valves, OSQ Flow Amplifiers

Priority Valves OLSA and OLS

OLSA/OLS 80

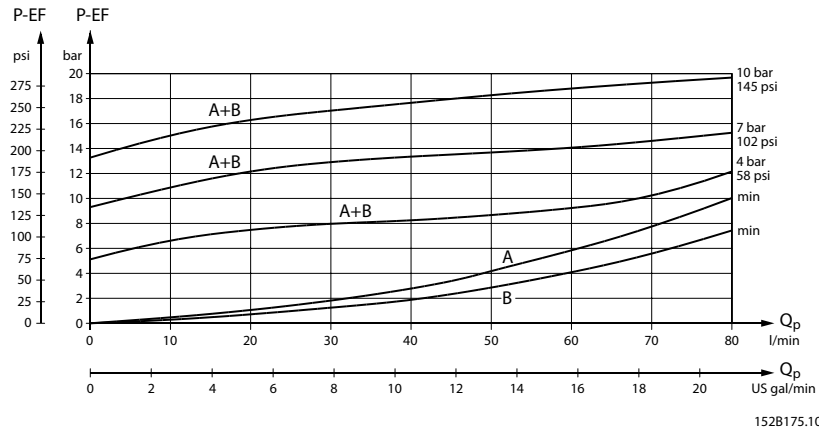

A: OLS/OLSA 80 Dynamic for OSPB, OSPC, OSPF, OSPD, OSPQ, OSPL LS Dynamic

B: OLS/OLSA 80 Dynamic with low pressure drop (P-EF) spool for OSPB, OSPC, OSPD, OSPQ, OSPL LS Dynamic

OLS 120

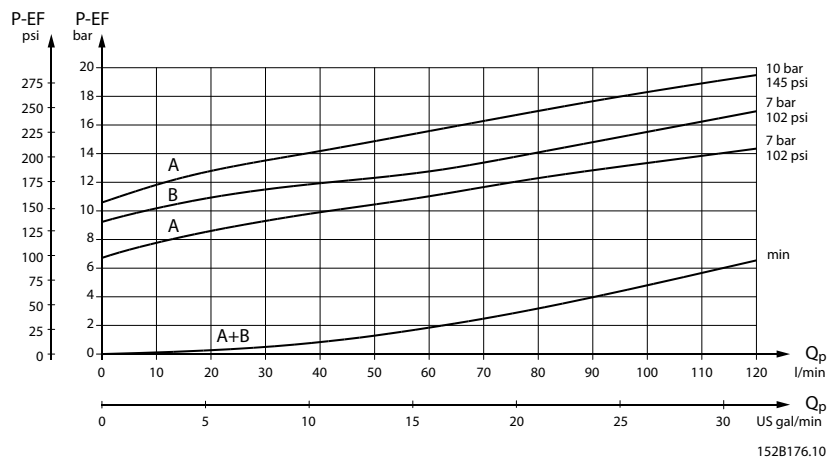

A: OLS 120 Dynamic for OSPB, OSPC, OSPD, OSPQ, OSPL LS Dynamic

B: OLS 120 Dynamic for OSPF LS Dynamic and for OSPU LS Dynamic

Technical Information

OSP/C/F/D/L LS Steering Units, OLS Priority Valves, OSQ Flow Amplifiers

Priority Valves OLSA and OLS

OLS 160

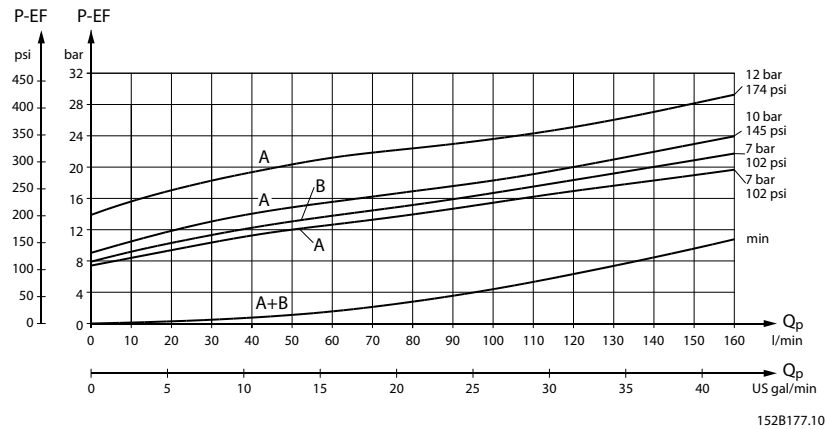

A: OLS 160 Dynamic for OSPB, OSPC, OSPD, OSPL LS Dynamic

B: OLS 160 Dynamic for OSPF LS and for OSPU LS Dynamic

Pressure drop P-EF for OLSP static priority valves

OLSP 80

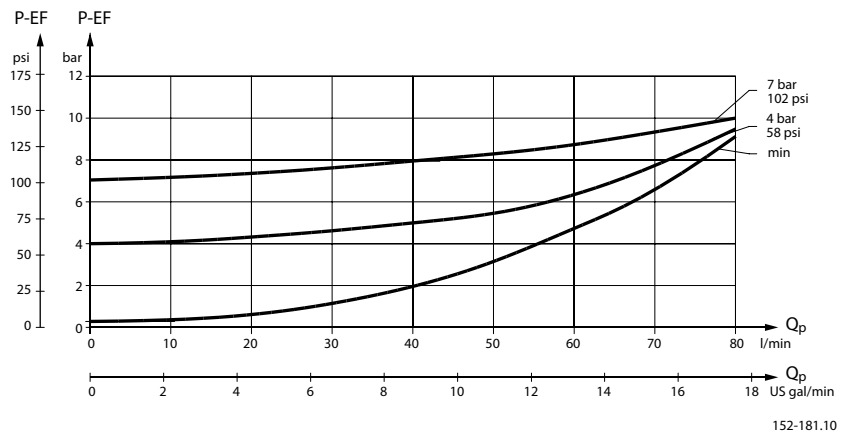

Technical Information

OSP/C/F/D/L LS Steering Units, OLS Priority Valves, OSQ Flow Amplifiers

Priority Valves OLSA and OLS

Pressure drop P-EF for OLSP dynamic priority valves

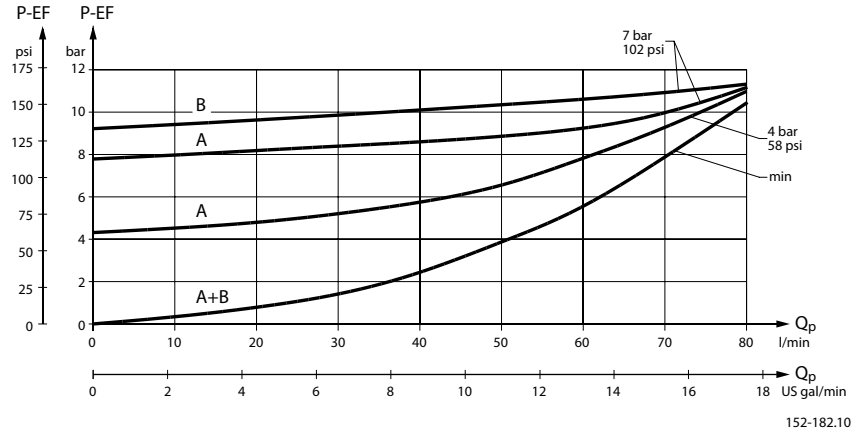

A: OLSP 80 Dynamic for OSPB, OSPC, OSPD, OSPL LS Dynamic

B: OLSP 80 Dynamic for OSPF LS and for OSPU LS Dynamic

Pressure drop P-EF for OLS 320 static priority valves

OLS 320

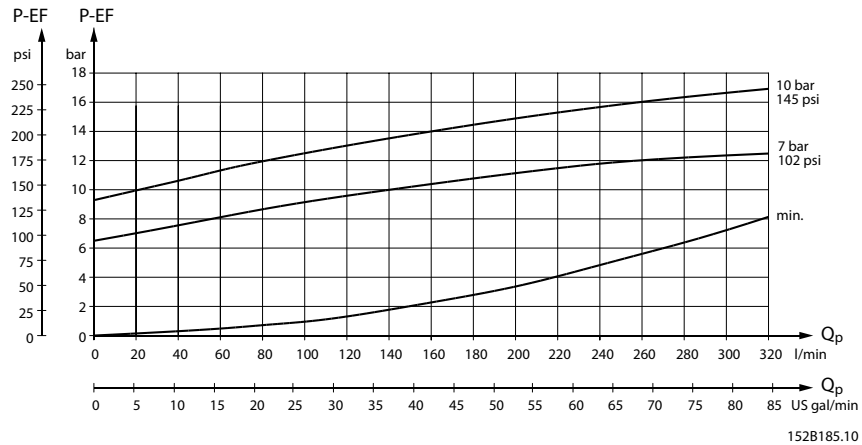

Priority Valves OLSA and OLS
Pressure drop P-EF for OLS 320 dynamic priority valves

OLS 320

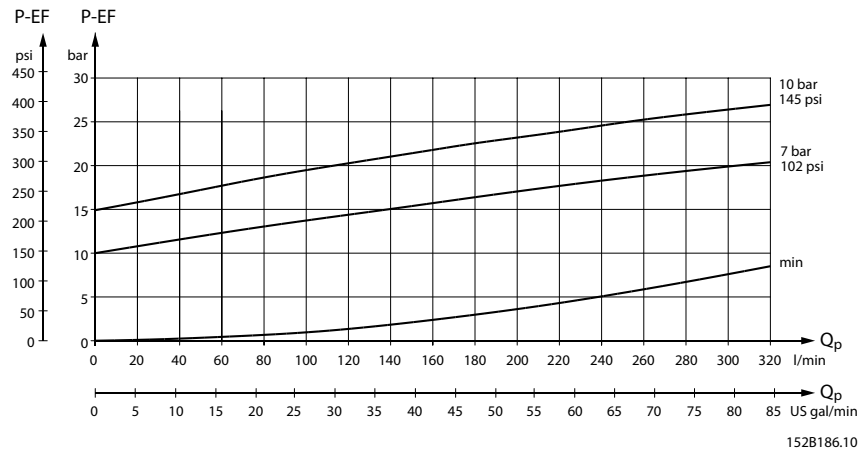
OLS 160 and OLS 320, pilot pressure relief valve (P - T, Q_p) characteristics

OLS 160 and OLS 320 with pilot pressure relief valves are used in connection with Danfoss steering units without pilot pressure relief valve, normally steering unit type OSPL. The pilot pressure relief valve protects the steering unit against excessive pressure. The pilot pressure relief valve in OLS 160/320 operates with the priority valve spool in the OLS 160/320 to limit the maximum steering pressure P-T measured across the steering unit ports.

OLS 160: The pilot pressure relief valve is set when an oil flow of 80 l/min [21 US gal/min] is supplied to OLS 160.

OLS 320: The pilot pressure relief valve is set when an oil flow of 40 l/min [11 US gal/min] is supplied to OLS 320.

OLS 160 and OLS 320: Setting tolerance: rated value +10 bar [145 psi]

OLS 160

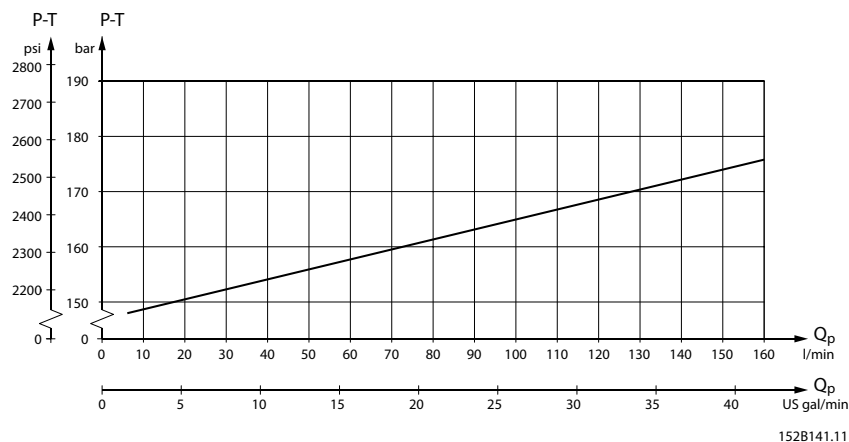

Technical Information

OSP/C/F/D/L LS Steering Units, OLS Priority Valves, OSQ Flow Amplifiers
Priority Valves OLSA and OLS

OLS 320

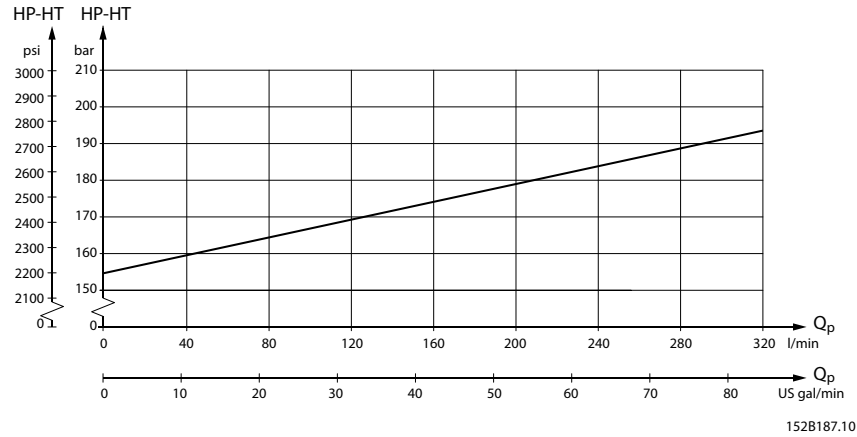

Technical Information

OSP/C/F/D/L LS Steering Units, OLS Priority Valves, OSQ Flow Amplifiers

Priority Valves OLSA and OLS

Dimensions

OLSA

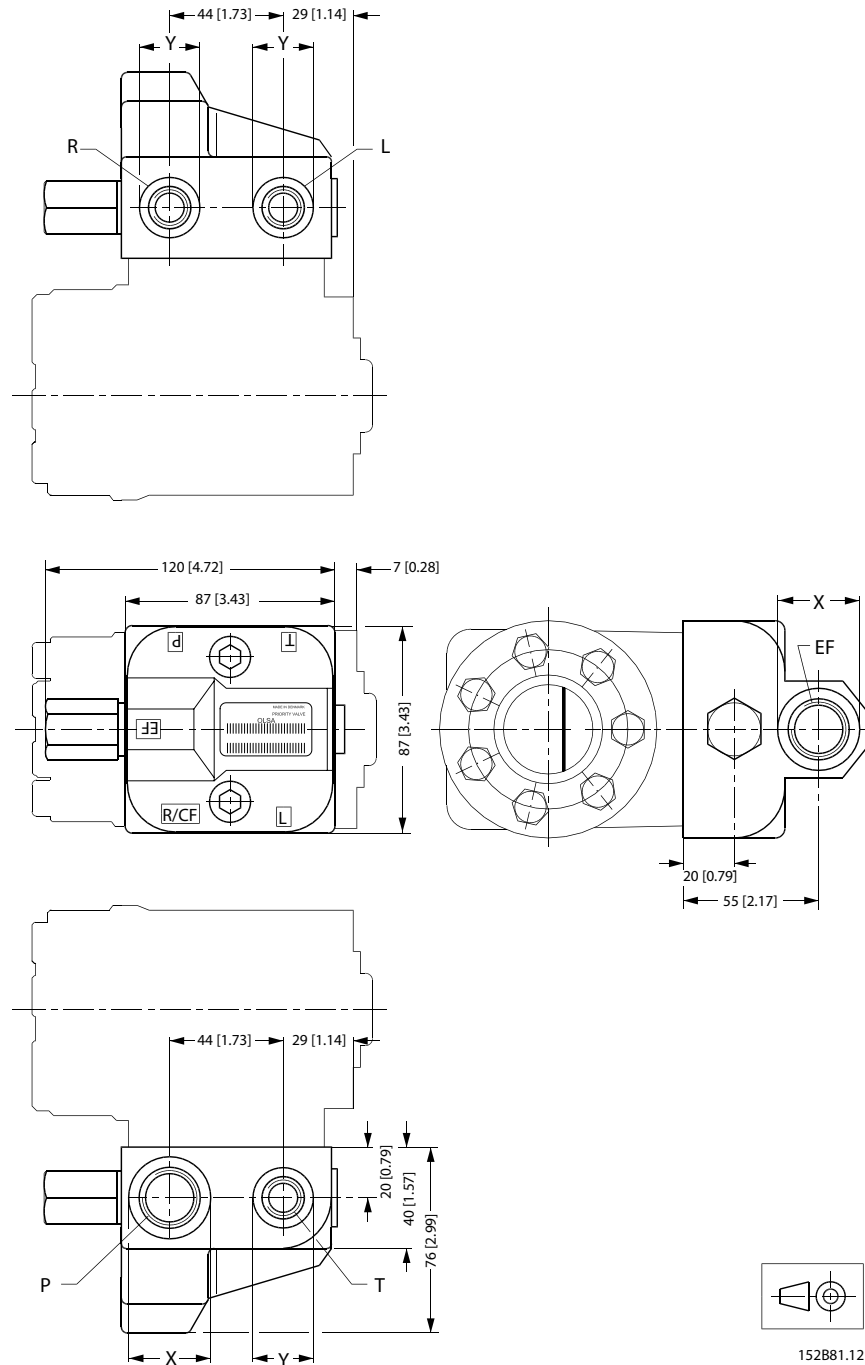

152881.12

Technical Information

OSP/C/F/D/L LS Steering Units, OLS Priority Valves, OSQ Flow Amplifiers

Priority Valves OLSA and OLS

European version:

P, EF:
G 1/2 w. spot face
14 mm [0.55 in] deep
x = 34 mm [1.34 in],
max. 1.5 mm [0.06 in] deep or M18 x 1.5 ISO 6149
14.5 mm [0.57 in] deep
x = 29 mm [1.14 in],
max. 1.5 mm [0.06 in] deep or M22 x 1.5 ISO 6149,
15.5 mm [0.61 in] deep
x = 34 mm [1.34 in],
max. 1.5 mm [0.06 in] deep

T, L, R:
G 3/8 w. spot face
12 mm [0.47 in] deep
y = 34 mm [1.34 in],
max. 1.5 mm [0.06 in] deep or M18 x 1.5 ISO 6149,
15 mm [0.59 in] deep
y = 29 mm [1.14 in],
max. 1.5 mm [0.06 in] deep

US version:

P, EF:
7/8-14 UNF O-ring boss
16.7 mm [0.66 in] deep
x = 34 mm [1.34 in],
max. 1.5 mm [0.06 in] deep

T, L, R:
9/16 - 18 UNF O-ring boss
12.7 mm [0.50 in] deep
y = 25 mm [0.98 in],
max. 1.5 mm [0.06 in] deep

OLS 40, OLS 80

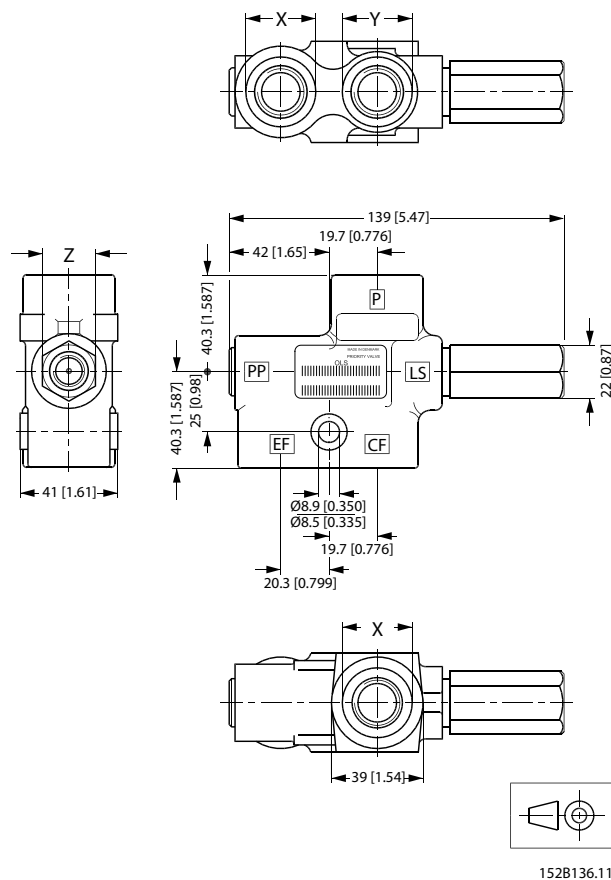

European version:

US version:

Technical Information

OSP/C/F/D/L LS Steering Units, OLS Priority Valves, OSQ Flow Amplifiers

Priority Valves OLSA and OLS

P, EF:
G 1/2 w. spot face
15 mm [0.59 in] deep
x = 29 mm [1.14 in],
max. 1.5 mm [0.06 in] deep
or M22 x 1.5 ISO 6149
15 mm [0.59 in] deep,
x = 34 mm [1.34 in],
max. 1 mm [0.04 in] deep

CF:
G 1/2 w. spot face
14 mm [0.55 in] deep
y = 29 mm [1.14 in],
max. 1.5 mm [0.06 in] deep or M18 x 1,5 ISO 6149
12 mm [0.47 in] deep,
y = 29 mm [1.14 in],
max. 1 mm [0.04 in] deep

LS:
G 1/4 w. spot face
12.5 mm [0.49 in] deep
z = 21 mm [0.83 in],
max. 1 mm [0.04 in] deep or M12 x 1,5 ISO 6149
12,5 mm [0.49 in] deep,
z = 22 mm [0.86 in]
0 mm deep

P, EF:
7/8 - 14 UNF O-ring boss
15 mm [0.59 in] deep
x = 34 mm [1.14 in],
max. 1.3 [0.05] deep

CF:
3/4-16 UNF O-ring boss
14.3 mm [0.56 in] deep
y = 30 mm [1.18 in],
max. 1.3 mm [0.05 in] deep

LS:
7/16-20 UNF O-ring boss
12.5 mm [0.49 in] deep
z = 21 mm [0.83 in],
max. 1 mm [0.04 in] deep

Priority Valves OLSA and OLS

OLS 120

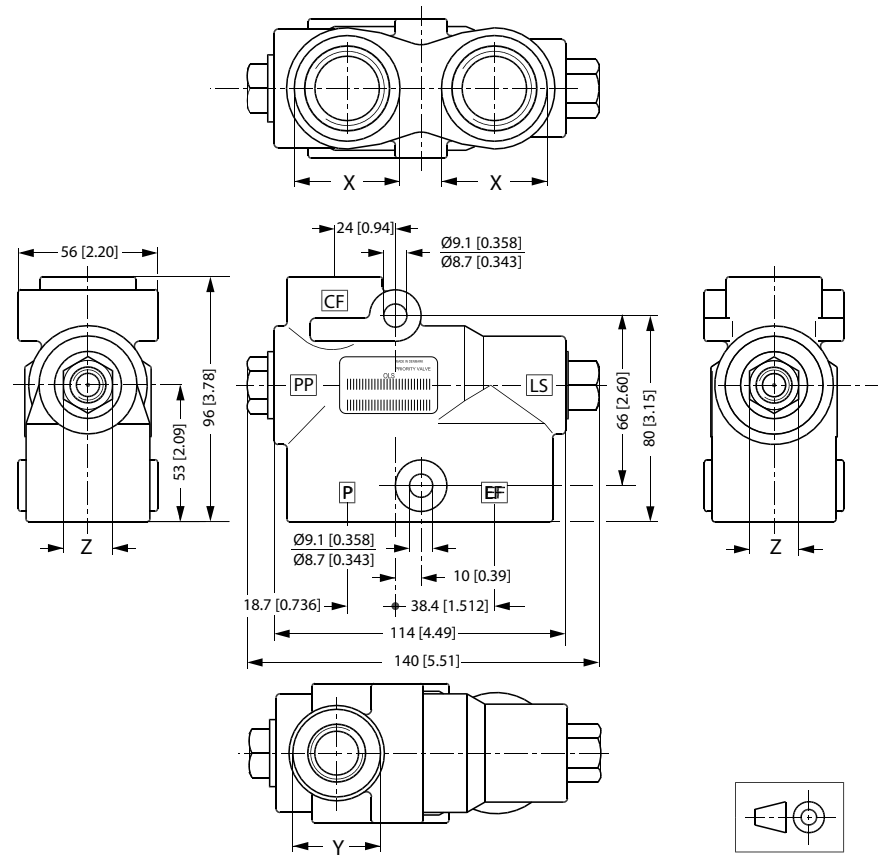

152B173.11

European version:

P, EF:
 G 3/4 w. spot face
 x = 42 mm [1.65 in],
 max. 2.5 mm [0.10 in] deep or M27 x 2 ISO 6149
 x = 40 mm [1.57 in],
 max. 2.5 mm [0.10 in] deep

CF:
 G 1/2 w. spot face
 y = 34 mm [1.34 in],
 max. 2.5 mm [0.10 in] deep or M18 x 1.5 ISO 6149
 y = 29 mm [1.14 in],
 max. 2.5 mm [0.10 in] deep

LS, PP:
 G 1/4 w. spot face
 12 mm [0.47 in] deep
 z = 19 mm [0.75 in]
 0 mm deep
 or M12 x 1,5 ISO 6149
 11,5 mm [0.45 in] deep,
 z = 19 mm [0.75 in]
 0 mm deep

US version:

P, EF:
 1 1/16 - 12 UN O-ring boss
 x = 41 mm [1.61 in],
 max. 1.5 mm [0.06 in] deep

CF:
 3/4 - 16 UNF O-ring boss
 y = 30 mm [1.18 in],
 max. 1.5 mm [0.06 in] deep

LS, PP:
 7/16 - 20 UNF O-ring boss
 11.5 mm [0.45 in] deep
 z = 19 mm [0.75 in] 0 mm deep

Technical Information

OSPB/C/F/D/L LS Steering Units, OLS Priority Valves, OSQ Flow Amplifiers
Priority Valves OLSA and OLS

OLS 160

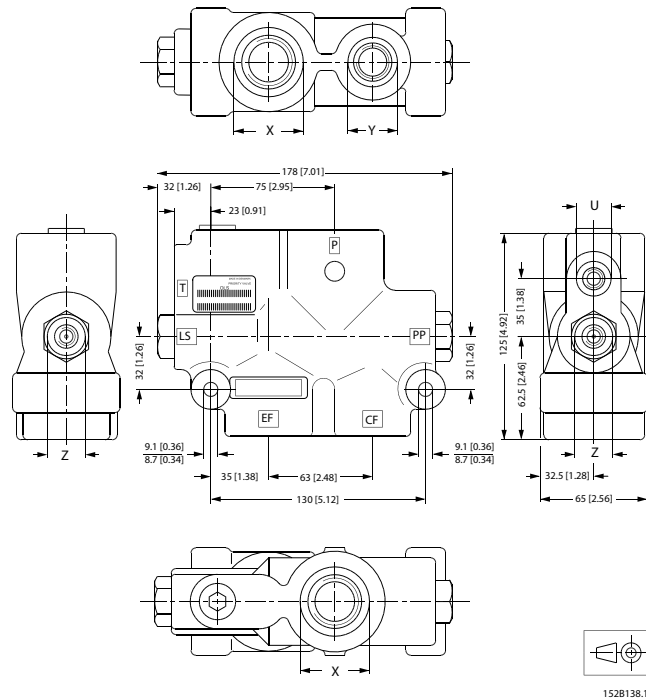
European version:

P, EF:
 G 3/4 w. spot face
 x = 42 mm [1.65 in],
 max. 2.5 mm [0.10 in] deep or G 1 w. spot face
 x = 47 mm [1.85 in],
 max. 2.5 mm [0.10 in] deep

CF:
 G 1/2 w. spot face
 y = 34 mm [1.34 in],
 max. 2.5 mm [0.10 in] deep or G 3/4 w. spot face
 y = 38 mm [1.50 in],
 max. 2.5 mm [0.10 in] deep

LS, PP, T:
 G 1/4 w. spot face
 12 mm [0.47 in] deep
 z = 22.8 mm [0.89 in],
 max. 1 mm [0.04 in] deep
 u = 25 mm [0.98 in]
 max. 1.5 mm [0.06 in] deep

US version:

P, EF:
 1 1/16-12 UNF O-ring boss
 x = 41 mm [1.61 in],
 max. 2.5 mm [0.10 in] deep or 1 5/16 - 12 UNF O-ring boss
 x = 49 mm [1.93 in],
 max. 2.5 mm [0.10 in] deep

CF:
 3/4-16 UNF O-ring boss
 y = 32 mm [1.26 in],
 max. 2.5 mm [0.10 in] deep
 7/8 - 14 UNF O-ring boss
 y = 30 mm [1.18 in],
 max. 2.5 mm [0.10 in] deep

LS, PP, T:
 7/16 - 20 UNF O-ring boss
 11.5 mm [0.45 in] deep
 z = 22,8 mm [0.89 in],
 max. 1.5 mm [0.06 in] deep
 u = 21 mm [0.83 in],
 max. 1.6 mm [0.06 in] deep

Technical Information

OSP/C/F/D/L LS Steering Units, OLS Priority Valves, OSQ Flow Amplifiers

Priority Valves OLSA and OLS

OLSP 80

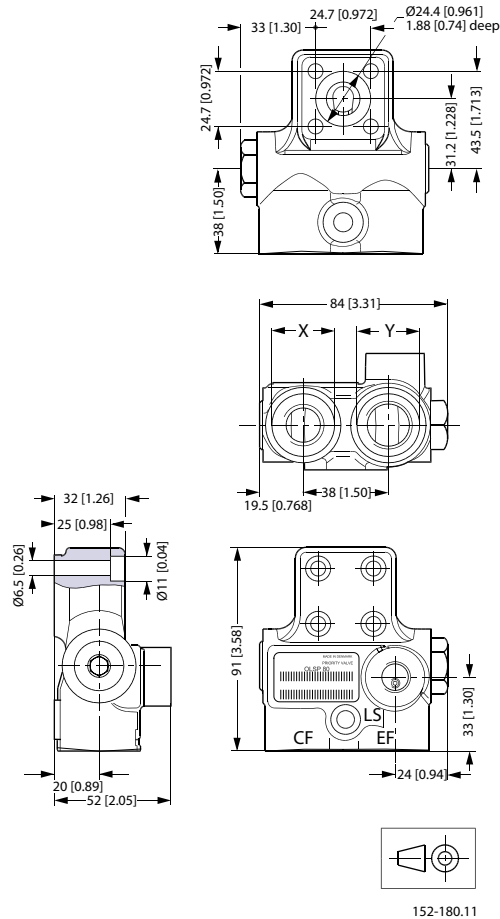

European version:

CF:
G 3/8 w. spot face
15 mm [0.59 in] deep
x = ø28, max. 1.5 mm [0.06 in] deep or M18 • 1.5 ISO 6149
15 mm [0.59 in] deep
y = ø29, max. 1.5 mm [0.06 in]

EF:
G 1/2 w. spot face
15 mm [0.59 in] deep
y = ø34, max. 1.5 mm [0.06 in] or M22 • 1.5 ISO 6149 15 mm [0.59 in] deep
x = ø34, max. 1.5 mm [0.06 in]

LS:
G 1/4 w. spot face
12.5 mm [0.49 in] deep or M12 • 1.5 ISO 6149 12.5 mm [0.49 in] deep

US version:

CF:
3/4-16 UNF O-ring boss
15 mm [0.59 in] deep
x = ø29 [1.14 in]
max. 1.5 mm [0.06 in] deep

EF:
7/8 - 14 UNF O-ring boss
16.7 mm [0.66 in] deep
y = ø34 [1.34 in]
max. 1.5 mm [0.06 in] deep

LS:
7/16 - 20 UNF O-ring boss
12.5 mm [0.49 in] deep

Technical Information

OSP/C/F/D/L LS Steering Units, OLS Priority Valves, OSQ Flow Amplifiers

Priority Valves OLSA and OLS

OLS 320 in-line

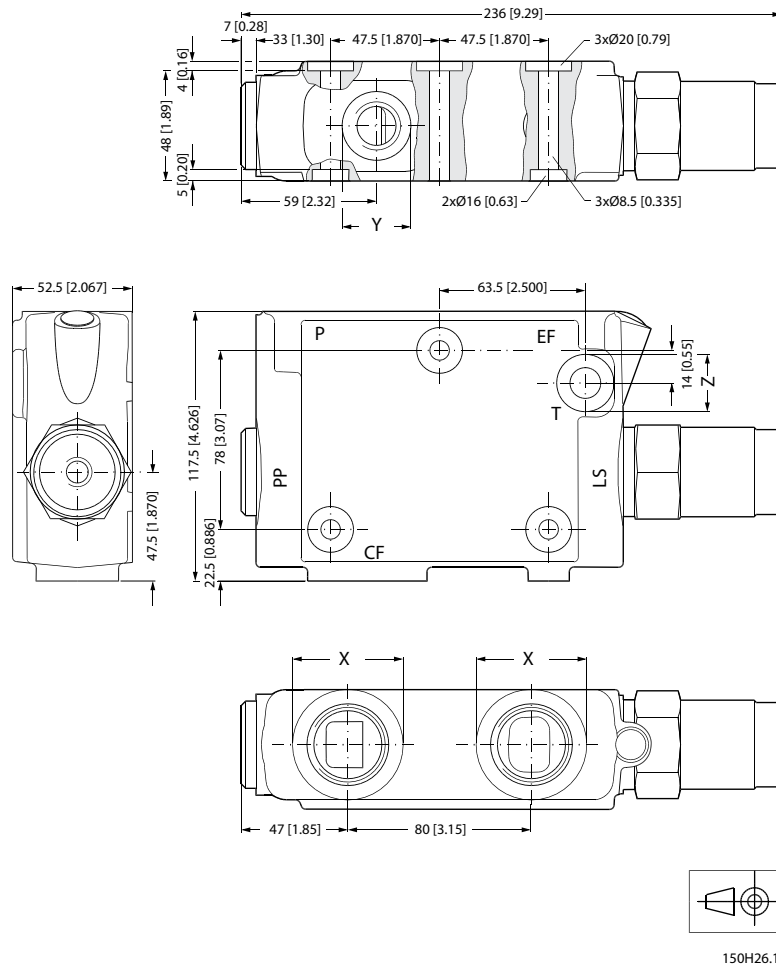

European version:

P, EF:
G 1 w. spot face
x = $\varnothing 47$ mm [1.85 in]
max 1 mm [0.04 in] deep

CF:
G 1/2 w. spot face
y = $\varnothing 34$ mm [1.34 in]
max 2.5 mm [0.10 in] deep

LS, PP:
G 1/4 w. spot face

T:
G 1/4 w. spot face
z = $\varnothing 25$ mm [0.98 in]
max 1.5 mm [0.06 in] deep

US version:

P, EF:
1 5/16-12 UN O-ring boss
x = $\varnothing 49$ mm [1.93 in]
max 0.2 mm [0.01 in] deep

CF:
1 1/16-12 UN O-ring boss
y = $\varnothing 41$ mm [1.61 in]
max 0.2 mm [0.01 in] deep or 3/4-16UNF O-ring boss
y = $\varnothing 30$ mm [1.18 in]
max 0.2 mm [0.01 in] deep

LS, PP, T:
7/16-20 UNF O-ring boss

Technical Information

OSP/C/F/D/L LS Steering Units, OLS Priority Valves, OSQ Flow Amplifiers

Flow Amplifiers OSQA, OSQB and OSQB/OLSQ

Versions

OSQA and OSQB static

Flow amplifier OSQ is used in steering systems of large vehicles and vessels that need high oil flow for their steering. A steering system of this nature consists of a steering unit and a flow amplifier.



OSQA static

OSQB static

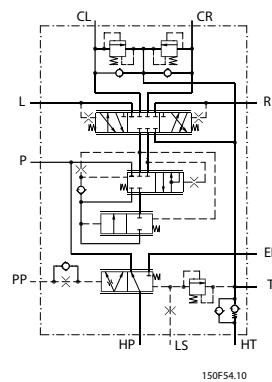
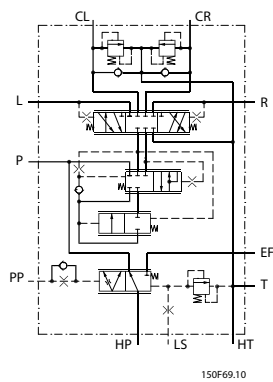
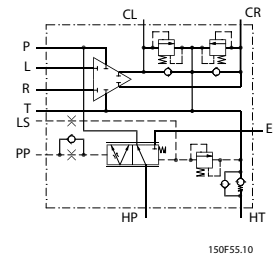
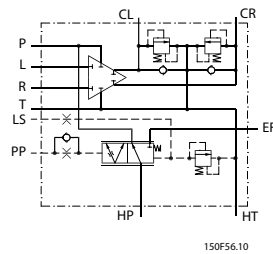

Technical Information

OSPB/C/F/D/L LS Steering Units, OLS Priority Valves, OSQ Flow Amplifiers
Flow Amplifiers OSQA, OSQB and OSQB/OLSQ
OSQB dynamic with OLSQ priority valve for emergency steering

F301 256

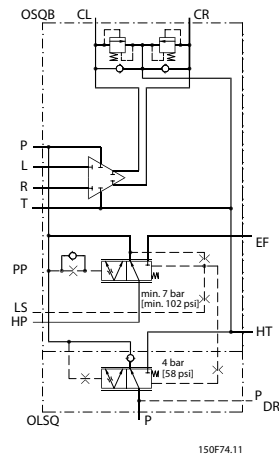

150F74.11

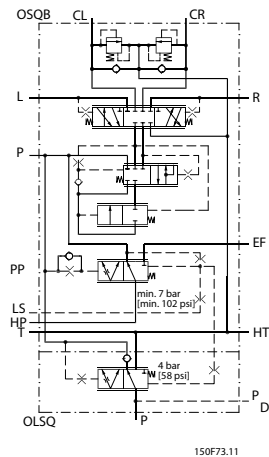

150F73.11

Code numbers and weights
OSQA and OSQB static flow amplifiers for load sensing static steering units

These flow amplifiers have to be used in connection with steering units type OSPBX LS or OSPLX LS.

Flow amplifier	Code numbers		Setting pressures		Control spring pressure bar [psi]	Weight kg [lb]
	Connections: see <i>Dimensions</i> on page 80		Pilot pressure relief valve bar [psi]	Shock valves bar [psi]		
	European version	US version				
OSQA 4	150F0040	150F0043	170 [2465]	230 [3335]	7 [101]	29 [64]
OSQA 5	150F0041	150F0044	170 [2465]	230 [3335]	7 [101]	29 [64]
OSQA 8	150F0042	150F0045	170 [2465]	230 [3335]	7 [101]	29 [64]
OSQB 4	150F0030	150F0053	170 [2465]	230 [3335]	7 [101]	29 [64]
OSQB 5	150F0031	150F0054	170 [2465]	230 [3335]	7 [101]	29 [64]
OSQB 8	150F0032	150F0055	170 [2465]	230 [3335]	7 [101]	29 [64]
OSQB 10	-	150F0094	170 [2465]	260 [3770]	7 [101]	29 [64]

OSQB/OLSQ dynamic flow amplifier for load sensing dynamics steering units

OSQB with OLSQ has no pilot pressure relief valve.

Technical Information

OSP/B/C/F/D/L LS Steering Units, OLS Priority Valves, OSQ Flow Amplifiers

Flow Amplifiers OSQA, OSQB and OSQB/OLSQ

This flow amplifier has to be used in connection with steering unit type OSP/CX LS, which has incorporated pilot pressure relief valve

Flow amplifier	Code numbers	Setting pressures	Control spring pressure bar [psi]	Weight kg [lb]
	Connections see <i>Dimensions</i> on page 80 European version	Shockvalves bar [psi]		
OSQB 8/OLSQ	150F8010	260 [3770 psi]	7 [101.5]	32 [70.6]

If you require other amplification factors, other valve settings or other control spring pressures, please fill in the order form under *Specification table for non catalogue numbers of Danfoss Priority Valves* on page 55 and contact the Danfoss Sales Organization.

Technical Information

OSP/C/F/D/L LS Steering Units, OLS Priority Valves, OSQ Flow Amplifiers
Flow Amplifiers OSQA, OSQB and OSQB/OLSQ
Specification table for non catalogue numbers of Danfoss Flow Amplifier

Fill in your company data and place x's in the table where appropriate, then send to your Danfoss Sales Organization

Your company	Name	Vehicle	Potential pcs/year	Completed by	Date	
Your application	Pump flow to OSQ at idle, l/min [US gal/min]			Pump flow to OSQ at max engine speed, l/min [US gal/min]		
Flow amplifier type	OSQA	OSQB	OSQB/OLSQ			
Amplification factor	4	5	8	9.1	16.5	
Load sensing type	Static		Dynamic			
Control spring bar	7 [101]		10 [145]		16 [232]	
PP-connection	Internal			External		
Ports, OSQA	G: European version HP, EF, HT, CL, CL: G 3/4 P, T, L, R: G 1/2 PP, LS: G 1/4		UNF: US version HP, EF, HT, CL, CR: 1 1/16 - 12 UN P, T, L, R: 3/4 - 16 UNF PP, LS: 7/16 - 20 UNF			
Ports, OSQB	G: European version HP, EF: 1 1/4 in SAE flange HT, CL, CR: 1 in SAE flange P, T, L, R: G 1/2 PP, LS: G 1/4		UNF: US version HP, EF: 1 1/4 in SAE flange HT, CL, CR: 1 in SAE flange P, T, L, R: 3/4 - 16 UNF PP, LS: 7/16 - 20 UNF			
Ports, OSQB/OLSQ	G: (European version) HP, EF: 1 1/4 in SAE flange HT, CL, CR: 1 in SAE flange POSQ, POLSQ, T, L, R: G 1/2 PP, LS: G 1/4					
Pilot pressure relief valve bar [psi]	100 [1450]	120 [1740]	140 [2030]	170 [2465]	210 [3045]	No relief valve (only OSQB/OLSQ)
Shock valves, bar [psi]	165 [2393]	200 [2900]	230 [3335]	260 [3770]	270 [3916]	
Back pressure valve	Yes (Only OSQB)			No		
Unit black painted	Yes			No		

An alternative way to specify a variant is to state an existing code number and add the modifications, you would like to have implemented in the basic flow amplifier.

Code number of basic flow amplifier: _____

Requested modifications:

Technical Information

OSP/C/F/D/L LS Steering Units, OLS Priority Valves, OSQ Flow Amplifiers
Flow Amplifiers OSQA, OSQB and OSQB/OLSQ
Technical data
Flow and pressure

Flow amplifier	Rated flow to HP-connection l/min [US gal/min]	Max. pressure on connections			
		HP, EF, CL CR bar [psi]	LS, PP, P, L, R bar [psi]	HT bar [psi]	T bar [psi]
OSQA	240 [63.4]	280 [4061]	240 [3480]	15 [217.5]	15 [217.5]
OSQB	400 [106]	280 [4061]	240 [3480]	10 [145]	15 [217.5]

Total displacement of Steering System

Flow amplifier	Amplification factor	Steering unit							
		OSP BX/OSPCX LS				OSPLX LS			
		160 cm ³ /rev [in ³ /rev]	200 cm ³ /rev [in ³ /rev]	315 cm ³ /rev [in ³ /rev]	400 cm ³ /rev [in ³ /rev]	520 cm ³ /rev [in ³ /rev]	630 cm ³ /rev [in ³ /rev]	800 cm ³ /rev [in ³ /rev]	
OSQA 4	4	640 [39]	800 [49]	1260 [77]	1600 [98]	2080 [127]			
OSQA 5	5	800 [49]	1000 [61]	1575 [96]	2000 [122]				
OSQA 8	8	1280 [78]	1600 [98]						
OSQA 10	9.1	1456 [89]							
OSQB 4	4					2080 [127]	2520 [154]	3200 [195]	
OSQB 5	5				2000 [122]	2600 [159]	3150 [192]	4000 [244]	
OSQB 8	8			2520 [154]	3200 [195]	4160 [254]			
OSQB 10	9.1		1820 [111]	2865 [175]	3640 [222]				
OSQB 20	16.5	2640 [161]	3300 [201]						

Installation

The flow amplifier has to be mounted on a flat surface.

Mounting screw	Tightening torque, Nm [lbf.in]
M 10 x 1.5	30 ±5 [265 ±44]
3/8 - 16 UNC	40 ±5 [354 ±44]
7/16 - 14 UNC	55 ±5 [487 ±44]

Tightening torque for fittings: Look in sub catalogue "General Steering Components" page 36.

Valve functions in the flow amplifiers

 The data below come from measurements on a representative sample of flow amplifiers from production. Oil with viscosity of 21 mm²/s [102 SUS] at 50 °C [122 °C] was used during measuring.

Priority valve

The priority valve is used in load sensing systems where the same pump supplies oil to both the steering system and working hydraulics. The steering system always has first priority. Measurements were made when the pressure on the LS connection is zero (steering unit is in neutral position). The minimum curves apply when the pressure on the EF connection is higher than the actual control spring pressure. The curves for control spring pressure of 7 bar [101.5 psi] apply when the pressure on the EF connection is zero

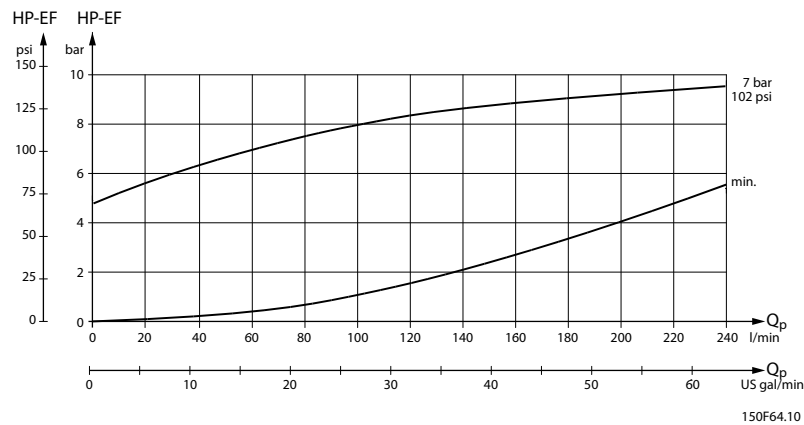
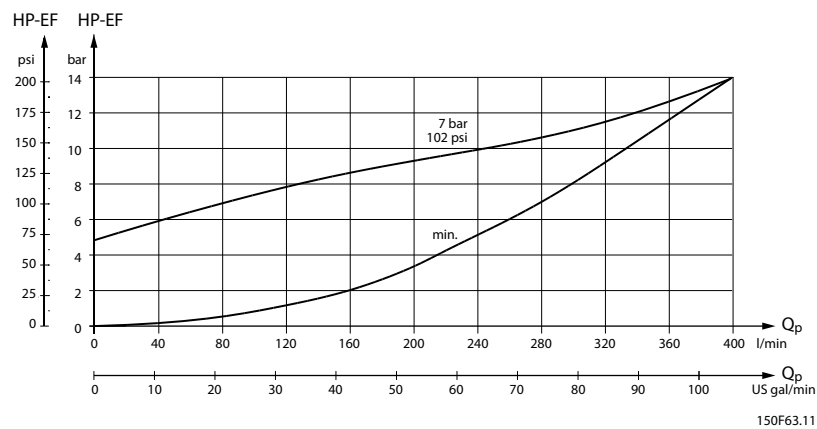
Flow Amplifiers OSQA, OSQB and OSQB/OLSQ
OSQA

OSQB

OSQ pilot pressure relief valve (HP - HT, Qp) characteristic

The pilot pressure relief valve protects the steering valve against excessive pressure. The pilot pressure relief valve together with the priority valve limit the maximum steering pressure HP-HT.

The pilot pressure relief valve in OSQ is set with an oil flow of 140 l/min [37 US gal/min] supplied to the HP connection.

For OSQA the setting values are valid for pump flow 140 l/min [37 US gal/min].

For OSQB the setting values are valid for pump flow 240 l/min [63 US gal/min]: the setting is done at 140 l/min [37 US gal/min], but compensated to match 240 l/min [63 US gal/min].

Setting tolerance: rated value +10 bar [+145 psi]. The curves below are valid for rated settings 170 bar [2466 psi].

Technical Information

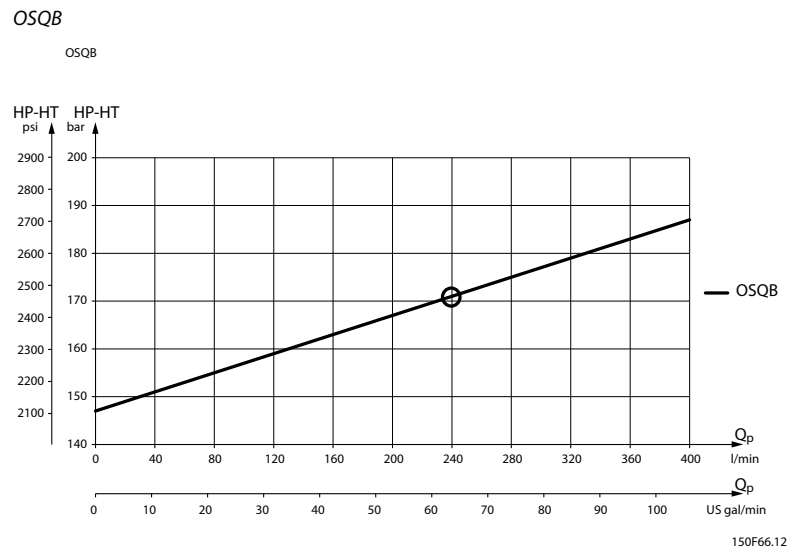
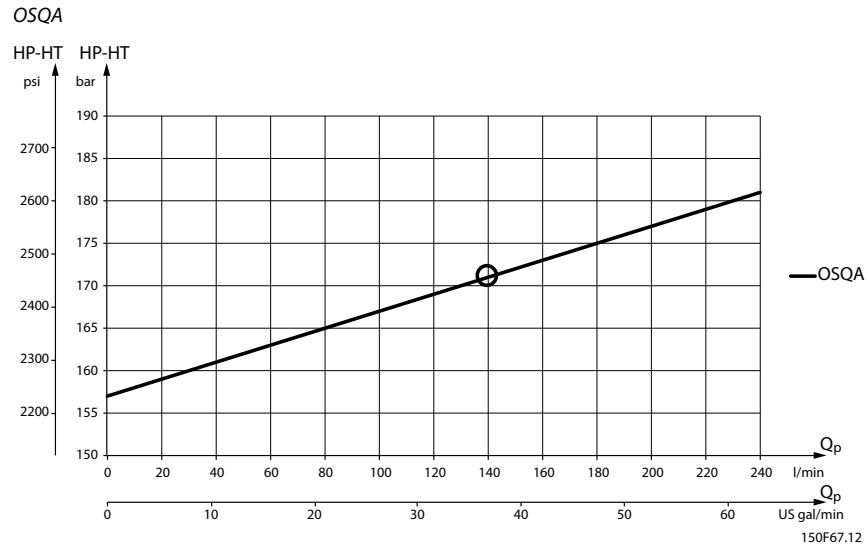
OSP/C/F/D/L LS Steering Units, OLS Priority Valves, OSQ Flow Amplifiers
Flow Amplifiers OSQA, OSQB and OSQB/OLSQ

Back pressure valve

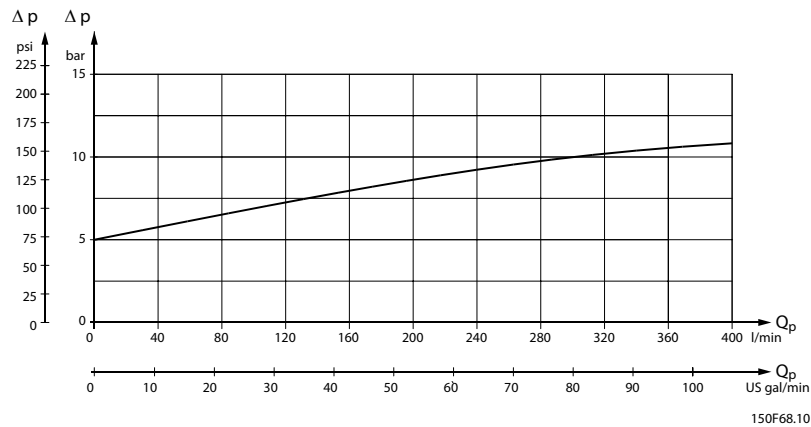
The back pressure valve in (OSQB only) increases the capacity of the suction valves. The pressure drop shown applies to the back pressure valve only.

Flow Amplifiers OSQA, OSQB and OSQB/OLSQ

Shock valves

The shock valves protect the flow amplifier against shock from external forces on the steering cylinders. The shock valves in OSQA and OSQB limit the maximum pressure drop from CL to HT and from CR to HT. The shock valves are set at 10 l/min [2.64 US gal/min].

Setting tolerance: rated value +20 bar [290 psi].

Suction valves

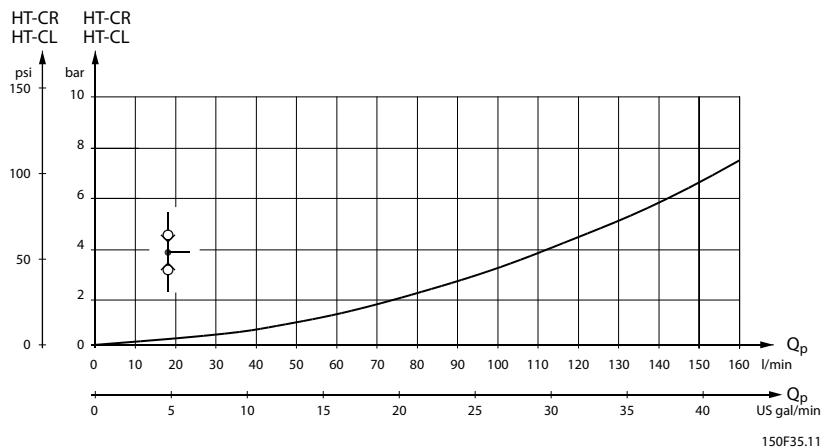
The suction valves ensure oil suction on the side of the steering cylinder pistons where in unfavorable conditions cavitation might occur. The capacity of the suction valves is increased in OSQB by the built-in back pressure valve.

Priority valve OLSQ for emergency circuit in OSQB/OLSQ

When under normal steering conditions the stand-by pressure in the main circuit (minimum 7 bar [101.5 psi] priority valve spring in OSQ) overrules the spring pressure in OLSQ (4 bar [58 psi] spring), OLSQ's priority valve will pass oil from the emergency steering pump across OLSQ's P-connection to the flow amplifier's HT tank connection.

Technical Information

OSP/C/F/D/L LS Steering Units, OLS Priority Valves, OSQ Flow Amplifiers

Flow Amplifiers OSQA, OSQB and OSQB/OLSQ

If the oil supply from the main pump should fail, the stand-by pressure of OSQ's priority valve in the main pump circuit disappears and relocates the spool in OLSQ to enable the oil from the emergency steering pump to enter the pump circuit in the OSQ.

The curve shows the pressure drop from OLSQ's P-connection to OSQ's HT-connection with an active main pump and neutral positioned steering. The curve solely applies to OSQs without any back pressure valve in the tank line.

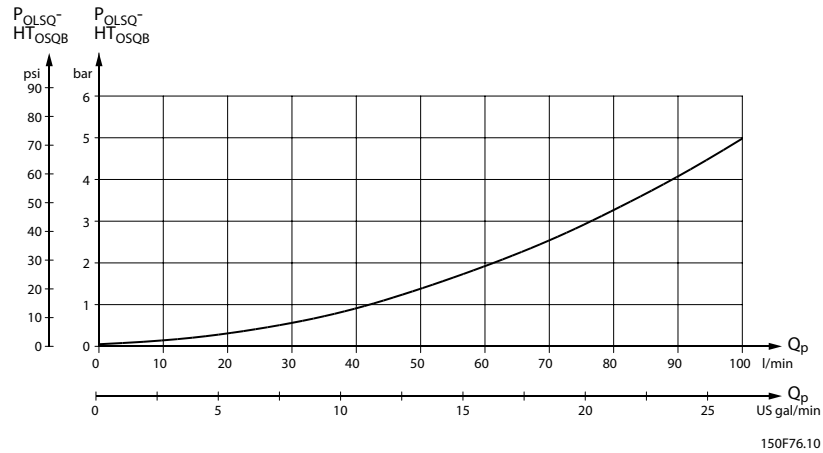

Technical Information

OSP/C/F/D/L LS Steering Units, OLS Priority Valves, OSQ Flow Amplifiers

Flow Amplifiers OSQA, OSQB and OSQB/OLSQ

Dimensions

OSQA

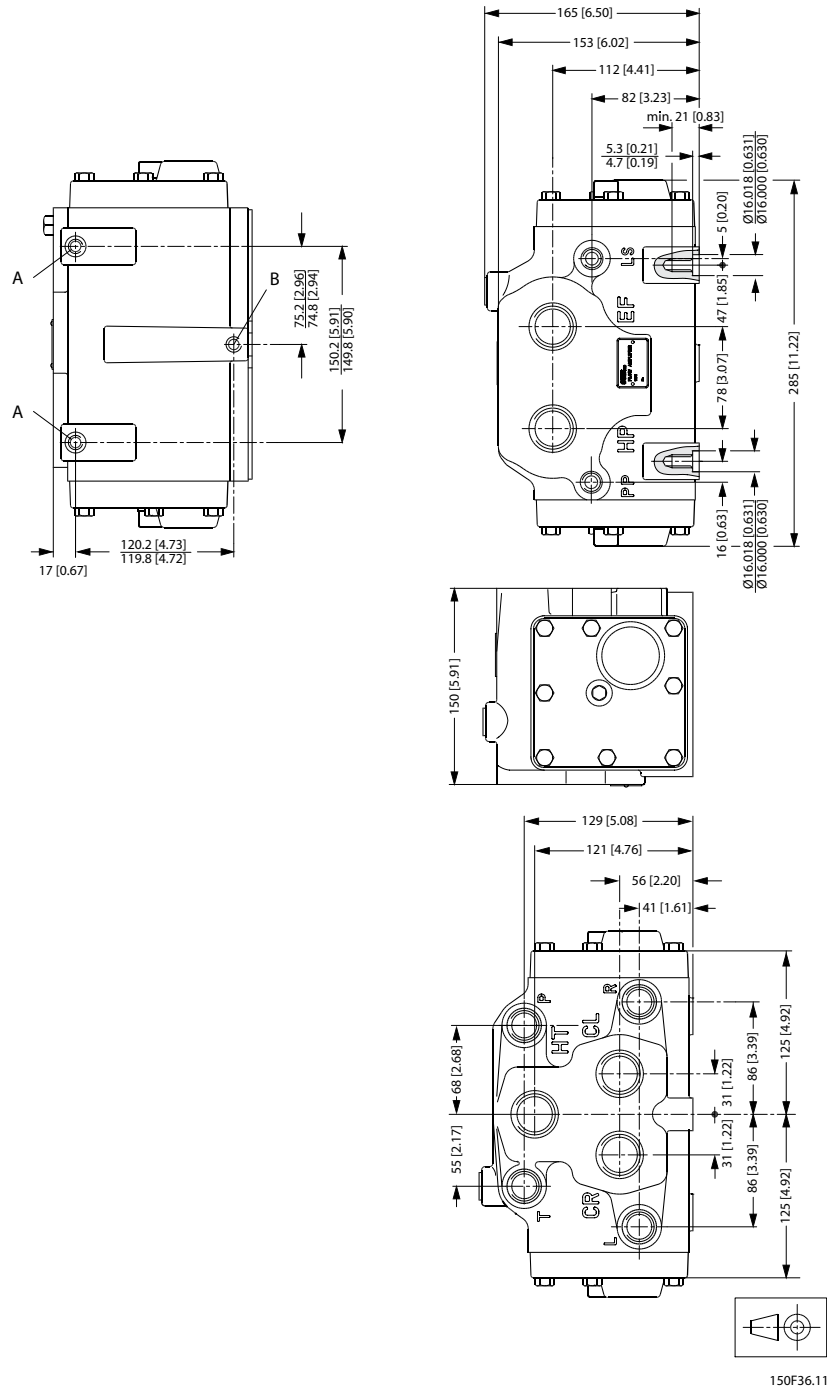

Technical Information

OSP/C/F/D/L LS Steering Units, OLS Priority Valves, OSQ Flow Amplifiers

Flow Amplifiers OSQA, OSQB and OSQB/OLSQ*European version:*HP, EF, HT, CL, CR: G 3/4
P, T, L, R: G 1/2
PP, LS: G 1/4A: M10 x 1.5, 21 mm [0.83in] deep
B: M10 x 1.5, 16 mm [0.63 in] deep*US version:*HP, EF, HT, CL, CR: 1 1/16 - 12 UN
P, T, L, R: 3/4 - 16 UNF
PP, LS: 7/16 - 20 UNFA: 7/16 - 14 UNC, 21 mm [0.83 in] deep
B: 7/16 - 14 UNC, 16 mm [0.63 in] deep

Technical Information

OSPB/C/F/D/L LS Steering Units, OLS Priority Valves, OSQ Flow Amplifiers

Flow Amplifiers OSQA, OSQB and OSQB/OLSQ

OSQB

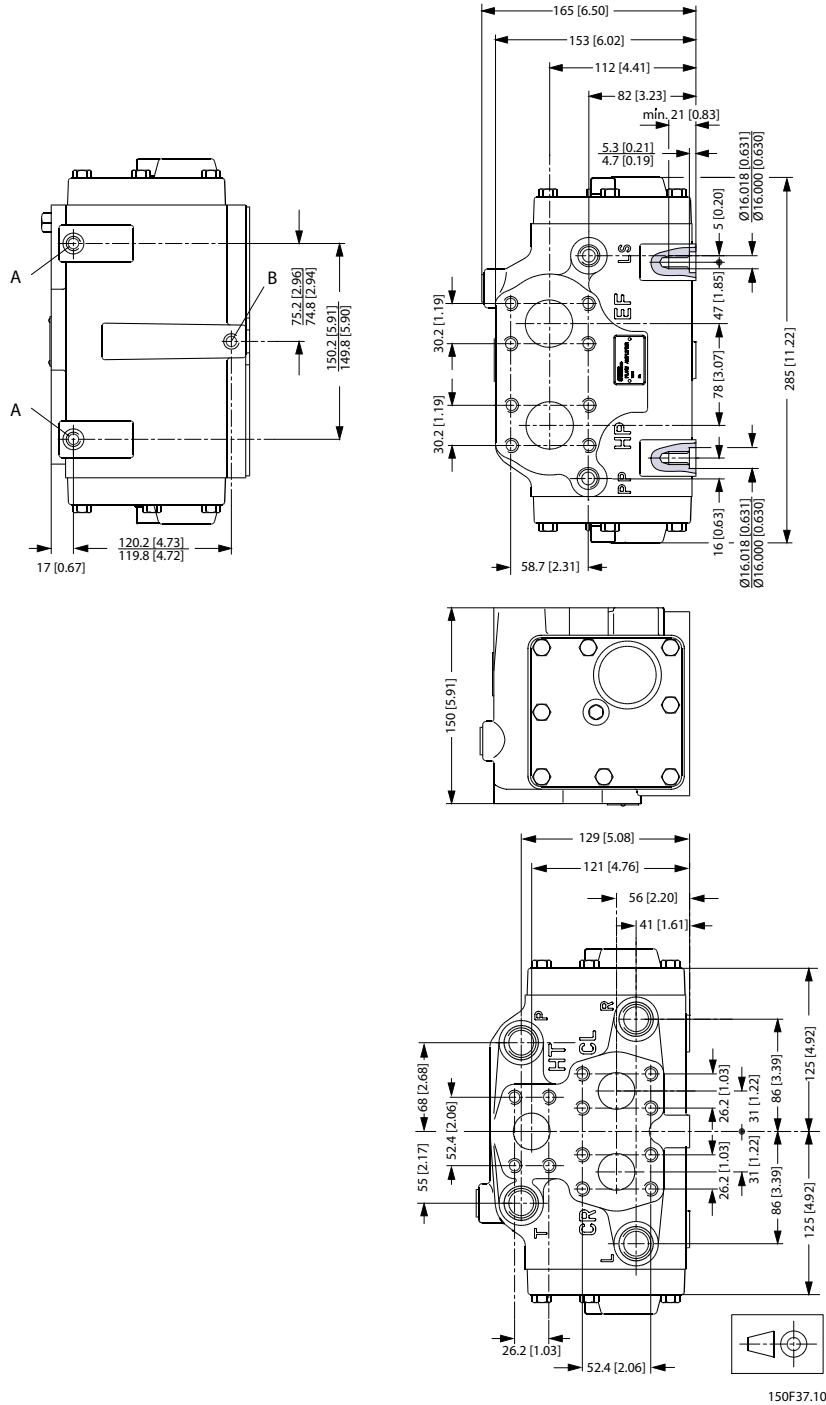

European version:

US version:

Technical Information

OSP/C/F/D/L LS Steering Units, OLS Priority Valves, OSQ Flow Amplifiers

Flow Amplifiers OSQA, OSQB and OSQB/OLSQ

HP, EF:
1 1/4 in SAE flange
7/16-14 UNC
18 mm [0.71 in] deep (8)

HT, CL, CR:
1 in SAE flange
3/8 - 16 UNC
18 mm [0.71 in] deep (12)

P, T, L, R: G 1/2
PP, LS: G 1/4

A: M10 x 1,5, 21 mm [0.83 in] deep
B: M10 x 1,5, 16 mm [0.63 in] deep

HP, EF:
1 1/4 in SAE flange
7/16 - 14 UNC
18 mm [0.71 in] deep (8)

HT, CL, CR:
1 in SAE flange
3/8 - 16 UNC
18 mm [0.71 in] deep (12)

P, T, L, R: 3/4 - 16 UNF
PP, LS: 7/16 - 20 UNF

A: 7/16 - 14 UNC, 21 mm [0.83 in] deep
B: 7/16 - 14 UNC, 16 mm [0.63 in] deep

Technical Information

OSP/C/F/D/L LS Steering Units, OLS Priority Valves, OSQ Flow Amplifiers

Flow Amplifiers OSQA, OSQB and OSQB/OLSQ

European version

HP, EF:
1 1/4 in SAE flange
7/16 - 14 UNC
18 mm [0.71 in] deep (8)

HT, CL, CR:
1 in SAE flange
3/8 - 16 UNC
18 mm [0.71 in] deep (12)

P_{OSQ}, P_{OLSQ}, T, L, R: G 1/2
PP, LS, P_{DR}: G 1/4

A: M10 x 1.5, 21 mm [0.83 in] deep
B: M10 x 1.5, 16 mm [0.63 in] deep



Hydraulik · Automation

Danfoss

Technical Information

OSP/C/F/D/L LS Steering Units, OLS Priority Valves, OSQ Flow Amplifiers



Hydraulik · Automation

Danfoss

Technical Information

OSPB/C/F/D/L LS Steering Units, OLS Priority Valves, OSQ Flow Amplifiers

Products we offer:

- Bent Axis Motors
- Closed Circuit Axial Piston Pumps and Motors
- Displays
- Electrohydraulic Power Steering
- Electrohydraulics
- Hydraulic Power Steering
- Integrated Systems
- Joysticks and Control Handles
- Microcontrollers and Software
- Open Circuit Axial Piston Pumps
- Orbital Motors
- PLUS+1* GUIDE
- Proportional Valves
- Sensors
- Steering
- Transit Mixer Drives

Danfoss Power Solutions is a global manufacturer and supplier of high-quality hydraulic and electronic components. We specialize in providing state-of-the-art technology and solutions that excel in the harsh operating conditions of the mobile off-highway market. Building on our extensive applications expertise, we work closely with our customers to ensure exceptional performance for a broad range of off-highway vehicles.

We help OEMs around the world speed up system development, reduce costs and bring vehicles to market faster.

Danfoss – Your Strongest Partner in Mobile Hydraulics.

Go to www.powersolutions.danfoss.com for further product information.

Wherever off-highway vehicles are at work, so is Danfoss. We offer expert worldwide support for our customers, ensuring the best possible solutions for outstanding performance. And with an extensive network of Global Service Partners, we also provide comprehensive global service for all of our components.

Please contact the Danfoss Power Solution representative nearest you.

Comatrol

www.comatrol.com

Turolla

www.turollaocg.com

Hydro-Gear

www.hydro-gear.com

Daikin-Sauer-Danfoss

www.daikin-sauer-danfoss.com

Local address:

Danfoss Power Solutions (US) Company
2800 East 13th Street
Ames, IA 50010, USA
Phone: +1 515 239 6000

Danfoss Power Solutions GmbH & Co. OHG
Krokamp 35
D-24539 Neumünster, Germany
Phone: +49 4321 871 0

Danfoss Power Solutions ApS
Nordborgvej 81
DK-6430 Nordborg, Denmark
Phone: +45 7488 2222

Danfoss Power Solutions Trading (Shanghai) Co., Ltd.
Building #22, No. 1000 Jin Hai Rd
Jin Qiao, Pudong New District
Shanghai, China 201206
Phone: +86 21 3418 5200

Danfoss can accept no responsibility for possible errors in catalogues, brochures and other printed material. Danfoss reserves the right to alter its products without notice. This also applies to products already on order provided that such alterations can be made without changes being necessary in specifications already agreed.
All trademarks in this material are property of the respective companies. Danfoss and the Danfoss logotype are trademarks of Danfoss A/S. All rights reserved.