



Niehues

Hydraulik · Automation

ENGINEERING
TOMORROW

Danfoss

Technical Information

PVG 128/256

Proportional Valve Group

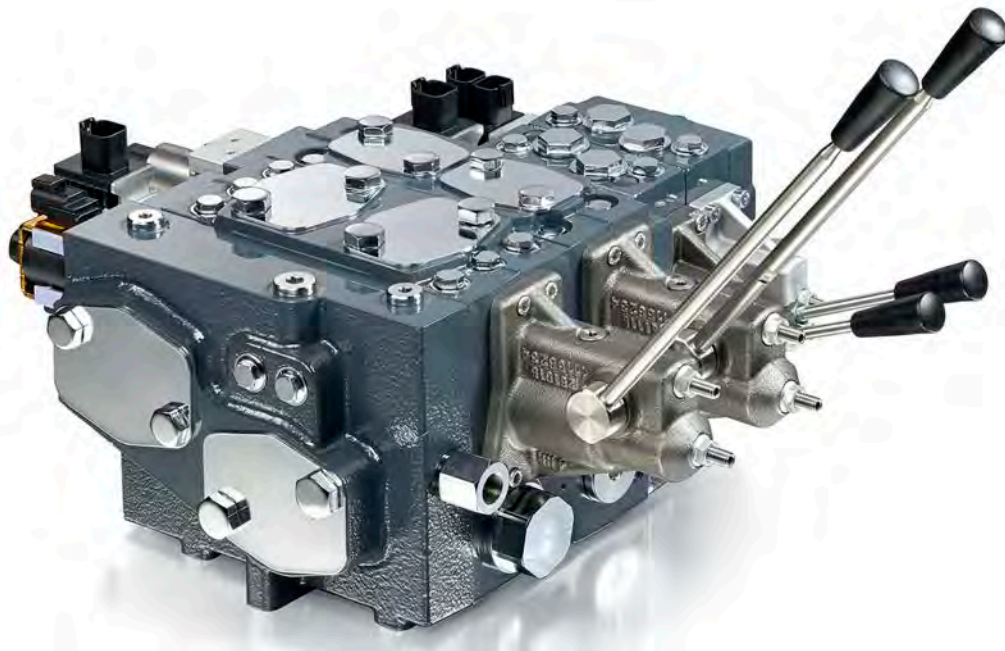

www.danfoss.com

Archivierung 05/2020

Revision history*Table of revisions*

Date	Changed	Rev
September 2018	Safety topic added.	0406
August 2018	Layout changes, minor edits	0405
June 2018	Table for dimensions page 90 update.	0404
March 2018	Minor edits	0403
January 2018	correction to part number pg 54	0402
October 2017	Updated port names on schematics	0401
July 2017	Updated specs and dimensions	0301
March 2017	Corrected PVAS equation	0203
March 2017	Updated PVAS tables	0202
January 2017	Changed PVEO and PVEH product data	0201
November 2016	First edition	0101

Contents
General Information

Safety in Systems.....	5
PVG 128/256 Proportional Valve Group.....	7
PVG general description.....	8
Features of the PVG 128/256 valve.....	8

PVPV Inlet Modules

Closed Center PPRV for PVE Activation and/or Mechanical.....	10
PPRV for PVH/PVHC Activation and/or Mechanical	12

PVB 128 Variant Overview

PVB 128 3-way Compensator.....	15
PVB 128 3-way Compensator with LS A/B.....	18
PVB 128 3-way Compensator with LS A/B and PVLP.....	22

PVB 256 Variant Overview

PVB 256 3-way Compensator.....	28
PVB 256 3-way Compensator with LS A/B.....	32
PVB 256 3-way Compensator with LSA/B and PVLP.....	36
PVB 256 3-way Compensator with LS A/B, PVLP and Turbo.....	41

PVLP Shock and PVLA Suction Valves

PVLP Overview.....	46
PVLP Technical Data.....	46

PVBS Main Spool

PVBS Main Spools variant overview.....	49
Flow control spools.....	49
PVBS main spools product details.....	49
PVS Main spools part numbers.....	51
Flow control spools.....	52
Flow control spool closed neutral position.....	52
Flow control spool throttled open neutral position.....	52
Single acting cylinder flow control spool closed neutral position, flow control B port.....	53
Flow control spool closed neutral position with A-float.....	54

PVM Manual Activation

PVM Technical Data.....	55
-------------------------	----

PVH Hydraulic Actuation

PVH Technical Data.....	57
-------------------------	----

PVHC Electro-Hydraulic Actuator type

PVHC Technical Data.....	59
--------------------------	----

PVMD Cover Manual Actuation Only

PVMD Part Numbers.....	60
------------------------	----

PVE Electrical Actuator

PVE Series 7 Electrical Actuator.....	61
---------------------------------------	----

PVE Variant Overview

PVE Variant Overview.....	63
PVEO.....	63
PVEO.....	64
PVEO Schematics and Dimensions.....	65
PVEO Technical Data.....	65
PVEO 128/256 Reaction Times.....	66
PVEO Variants for PVG.....	66
PVEH.....	67
PVEH Overview.....	67
PVEH Schematics and Dimensions.....	67
PVEH Technical Data.....	68
PVEH Reaction Times.....	69

Contents

	PVEH Hysteresis and Ripple.....	70
	PVEH Variants for PVG.....	70
Connector Overview	Connector Overview.....	71
Fault Monitoring and Reaction	Generic Fault Reaction.....	72
	PVEH Fault Reaction Overview.....	73
Functionality Overview	Standard and Fixed US 0-10 Vdc.....	74
	PWM Voltage Control.....	74
	Float A-Port (-FLA).....	76
	PVE Power Save.....	76
Special Features	Dedicated Float Pin (UF).....	77
	Disable Mode.....	77
Performance Overview	PVG 128/256 Reaction Times.....	78
	Hysteresis and Ripple.....	79
	Oil Consumption.....	79
PVSI/PVGI End and Interface Plates	PVSI with or without LX-connection.....	81
	PVSI with P and T port connections.....	82
	PVGI Interface Plate.....	83
PVAS	PVAS for Combo.....	85
	PVAS Part Number Overview.....	86
PVG Valve Schematics	Valve Schematics.....	88
Dimension Overview	Dimension Overview for PVG 128/256.....	90
	Specifications example.....	93

General Information

Safety in Systems

All types and brands of control valves, including proportional valves, can fail. Therefore, the necessary protection against the serious consequences of a functional failure should always be built into the system.

General safety considerations

For each application an assessment should be made for the consequences of the system in case of pressure failure and uncontrolled or blocked movements.

Warning

Because the proportional valve is used in many different applications and under different operating conditions, it is the sole responsibility of the manufacturer to ensure that all performance, safety and warning requirements of the application is met in his selection of products and complies with relevant machine specific and generic standards.

Control system example

An example of a control system using an aerial lift is shown below:

Aerial lift



This example breaks down the control system into smaller bits explaining the architecture in depth. Even though many Danfoss components are used in the PVG control system.

The function of the control system is to use the output from the PVE together other external sensors to ensure the PLUS+1 main controllers correct function of the aerial lift.

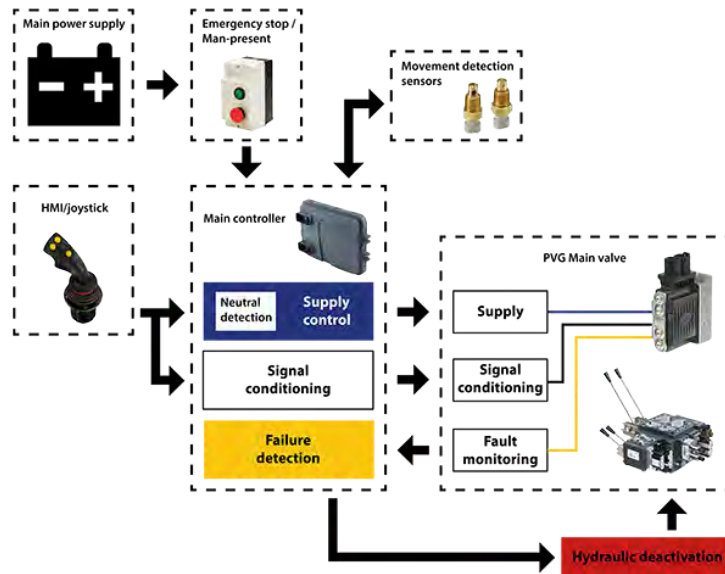
General Information
Electrical block diagram

⚠ Warning

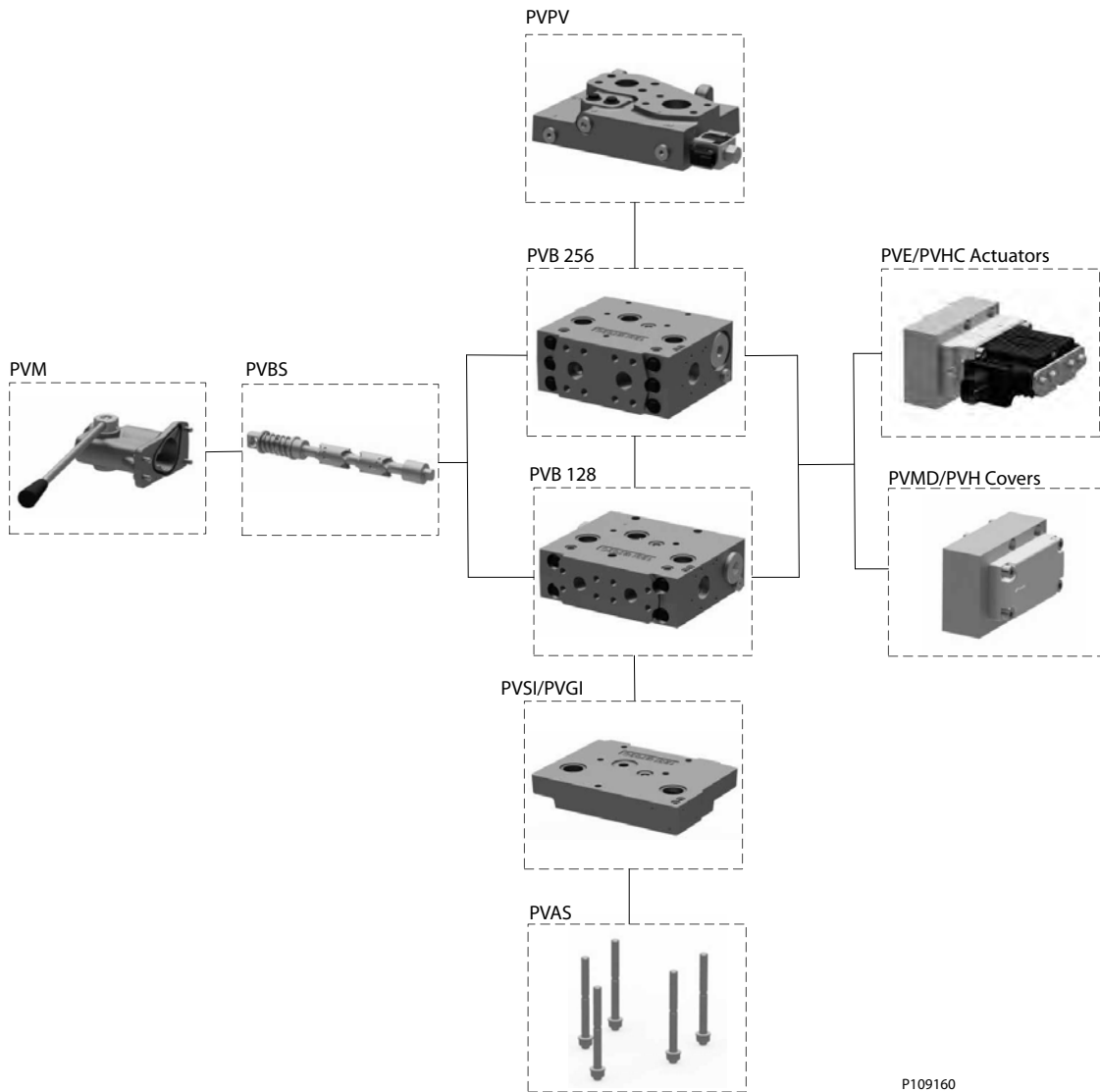
It is the responsibility of the equipment manufacturer that the control system incorporated in the machine is declared as being in conformity with the relevant machine directives.

General Information
PVG 128/256 Proportional Valve Group

Navigation

PVPV	PVB 256	PVB 128
PVBS Main Spool on page 49	PVM	PVE Series 7 Electrical Actuator on page 61/PVHC
PVMD/PVH Covers	PVS I/PVGI End and Interface Plates on page 80	PVAS

General Information

PVG general description

PVG is a hydraulic, load-sensing proportional valve, designed for optimal machine performance and maximum design flexibility.

The PVG valve design is based on a modular concept that enables machine designers to specify a valve solution suitable for multiple market segments across multiple applications.

The load independent proportional control valve and high performance actuator technology combined with a low pressure drop design improves the machine performance and efficiency – increasing productivity and reducing energy consumption.

Features of the PVG 128/256 valve

- Inlet flow up to 1200 l/min [317 US gal/min]
- Compact sectional platform solution for easy integration with PVG 16 and PVG 32
- Load-independent flow control:
 - Oil flow to an individual function is independent of the load pressure of this function
 - Oil flow to one function is independent of the load pressure of other functions
- Reliable regulation characteristics across the entire flow range
- Load sense relief valves for A and B port enables reduced energy loss at target pressure
- Optimized for lower pressure drop and higher efficiency
- Several options for connection threads and flange mount
- Compact design, easy installation and serviceability
- Static Load sense system when selecting pump control
- Internal T0 connection in all PVSI/PVGI

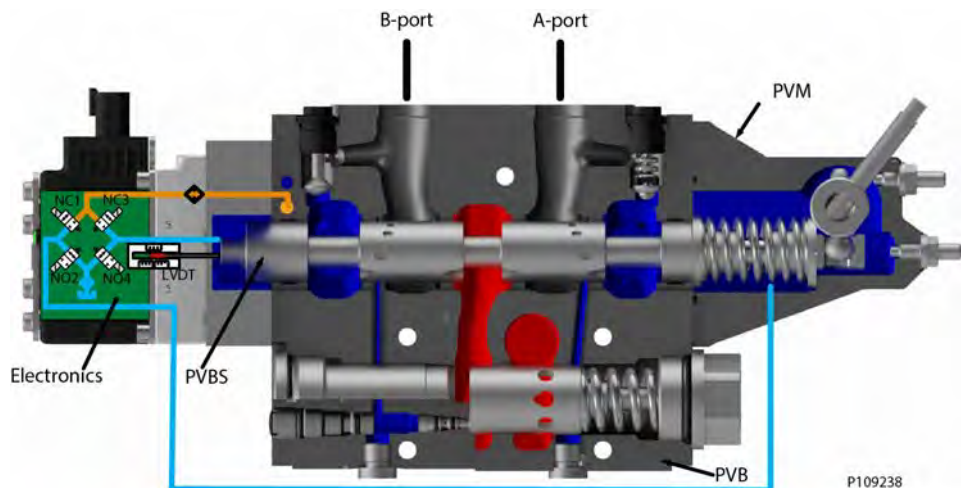

PVPV Inlet Modules

The Closed Center PVPV inlet with integrated pilot pressure reduction valve (PPRV) for PVE activation is intended for use with variable displacement pumps in applications where a valve group with electro-hydraulic or hydraulically controlled work sections is desired.

All Variants are prepared for 2xPVLV shock/anti-cavitation valves for pressure peak protection and anti-cavitation prevention.

PVLVs are for pressure peak protection in the system and pump.

Optional electrically actuated pilot shut off valve PVPP provides additional functional system safety by removing pilot oil from the electrical actuation or hydraulic actuation system, disabling main spool actuation.

All variants have internal T0 to tank connection in the PVSI and PVGI end plates.

PVPV 256

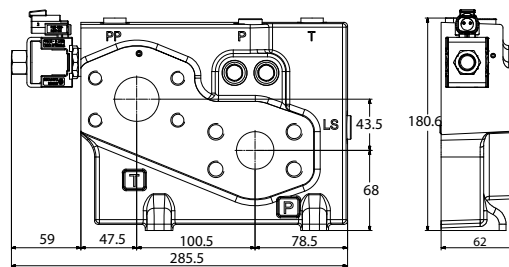
PVPV inlet module dimensions (mm)

Weight 10 kg [22 lbs]

The PVPV 256 inlet module variants are based on a generic platform with a selection of additional features, enabling you to tailor the PVPV inlet to suit the demands of any hydraulic system.

Variable displacement pump symbol

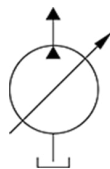

The generic PVPV 256 inlet module platform includes the following main variants:

Closed Center PVPV with PPRV PVE Closed center inlet module for variable displacement pumps.

Closed Center PVPV with PPRV for PVH/PVHC Closed center inlet module for variable displacement pumps.

Optional feature: PVPP Electrical Pilot Shut-Off Valve - Closed center inlet module for variable displacement pumps.

PVPV Inlet Modules
Closed Center PPRV for PVE Activation and/or Mechanical

The PVPV 256 inlet modules, also referred to as pump side modules, act as an interface between the PVG 128/256 proportional valve group and the hydraulic pump and tank reservoir.

Schematic

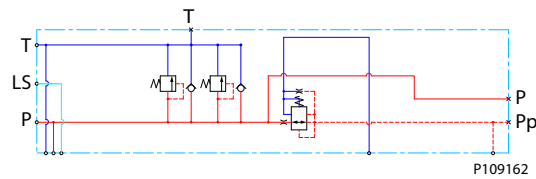

Technical data

Max. rated pressure	P-port continuous	350 bar	[5076 psi]
	P-port intermittent	400 bar	[5800 psi]
	T-port static/dynamic	25/40 bar	[363/580 psi]
Rated Port P (PVPV/PVSI)	P-port	600/600 l/min	[159/159 US gal/min]
Oil temperature	Recommended	30 to 60°C	[86 to 140°F]
	Minimum	-30°C	[-22°F]
	Maximum	90°	[194°F]
Ambient temperature	Recommended	-30 to 60°C	[-22 to 140°F]
Oil viscosity	Operating range	12 to 75 mm ² /s	[65 to 347 SUS]
	Minimum	4 mm ² /s	[39 SUS]
	Maximum	460 mm ² /s	[2128 SUS]
Oil contamination according to ISO 4406	Maximum	23/19/16	

Part numbers for Closed Center PVPV with PPRV for PVE

Part number	PPRV	P-port	T-port	LS-port Gauge-port	M-port Gauge-port	T/Pilot Gauge-port	Mounting feet
11173130	PVE	Metric Flange 1-1/4"	Metric Flange 1-1/2"	G3/8"BSP	G3/8"BSP	G1/4"BSP	M12
11176703	PVE	Thread Ports G1-1/2" BSP	Thread Ports G1-1/2" BSP	G3/8"BSP	G3/8"BSP	G1/4"BSP	M12
11176691	PVE	SAE Flange 1-1/4" UNF	SAE Flange 1-1/2" UNF	9/16-18 UNF	3/4-16 UNF	7/16-20 UNF	M12
11176702	PVE	Thread Ports 1-7/8" UNF	Thread Ports 1-7/8" UNF	9/16-18 UNF	3/4-16 UNF	7/16-20 UNF	M12

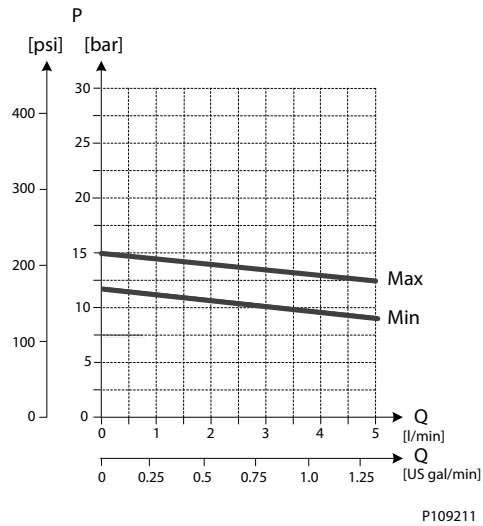
Technical Information

PVG 128/256 Technical Information
PVPV Inlet Modules
Pilot Pressure Reduction Valve Performance

Accessory module for PVPV 256

Ordering information	12 V	24 V
PVPP Pilot shut off valve	11160318	11160319

PVPV Inlet Modules
PPRV for PVH/PVHC Activation and/or Mechanical

The Closed Center PVPV inlet with integrated pilot pressure reduction valve (PPRV) for PVH/PVHC activation is intended for use with variable displacement pumps in applications where a valve group with PVH/PVHC controlled work sections is desired.

All Variants are prepared for 2xPVLV shock/anti-cavitation valves for pressure peak protection and anti-cavitation prevention.

Optional electrically actuated pilot shut off valve PVPP provides additional functional system safety by removing pilot oil from the electrical actuation or hydraulic actuation system, disabling main spool actuation.

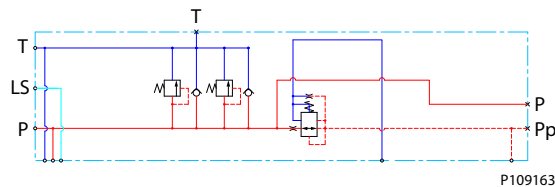
Schematic

Technical data

Max. rated pressure	P-port continuous	350 bar	[5076 psi]
	P-port intermittent	400 bar	[5800 psi]
	T-port static/dynamic	25/40 bar	[363/580 psi]
Rated Port P (PVPV/PVSI)	P-port	600/600 l/min	[159/159 US gal/min]
Oil temperature	Recommended	30 to 60°C	[86 to 140°F]
	Minimum	-30°C	[-22°F]
	Maximum	90°	[194°F]
Ambient temperature	Recommended	-30 to 60°C	[-22 to 140°F]
Oil viscosity	Operating range	12 to 75 mm ² /s	[65 to 347 SUS]
	Minimum	4 mm ² /s	[39 SUS]
	Maximum	460 mm ² /s	[2128 SUS]
Oil contamination according to ISO 4406	Maximum	23/19/16	

Part numbers for Closed Center PVPV with PPRV for PVH/PVHC

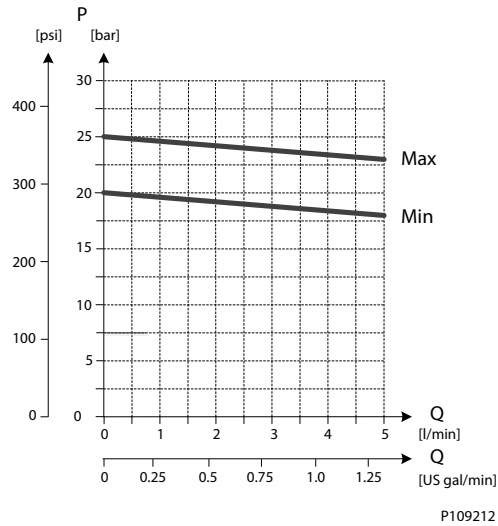
Part number	PPRV	P-port	T-port	LS-port Gauge-port	M-port Gauge-port	T/Pilot Gauge-port	Mounting feet
11178095	PVH/PVHC	Metric Flange 1-1/4"	Metric Flange 1-1/2"	G3/8"BSP	G3/8"BSP	G1/4"BSP	M12
11178098	PVH/PVHC	Thread Ports G1-1/2" BSP	Thread Ports G1-1/2" BSP	G3/8"BSP	G3/8"BSP	G1/4"BSP	M12
11178117	PVH/PVHC	SAE Flange 1-1/4" UNF	SAE Flange 1-1/2" UNF	9/16-18 UNF	3/4-16 UNF	7/16-20 UNF	M12
11178119	PVH/PVHC	Thread Ports 1-7/8" UNF	Thread Ports 1-7/8" UNF	9/16-18 UNF	3/4-16 UNF	7/16-20 UNF	M12

PVPV Inlet Modules
Pilot Pressure Reduction Valve Performance

Accessory module for PVPV 256

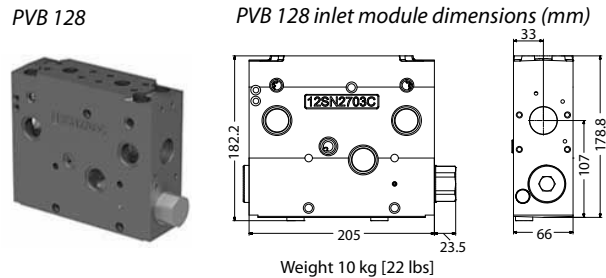
Ordering information	12 V	24 V
PVPP Pilot shut off valve	11160318	11160319

PVB 128 Variant Overview

The PVG 128 Basic modules (PVB), also referred to as work sections, is the interface between the PVG 128 proportional valve group and the work function such as a cylinder or a motor.

The PVB basic module variants are based on a generic platform with a selection of additional features, enabling you to tailor the PVB to suit the demands of any hydraulic system.

The compensator is a 3-way type which include load drop check valve functionality, compensator function and neutral relief which avoid A and B port pressure build up in neutral.

Symbol - compensated PVB

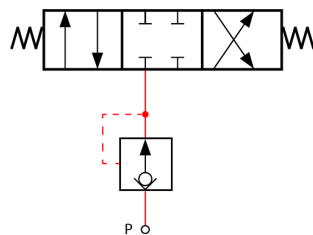

The generic PVB basic module platform includes the following main variants:

PVB 128 Compensated basic module.

Compensated PVB 128 w LSA/B Compensated basic module with LSA/B relief valve for each work port.

Compensated PVB 128 with LSA/B and PVLP Compensated basic module with LSA/B relief valve for each work port and 2xPVLPs for each work port.

⚠ Warning

Risk of leak

The module will leak if the flange mount screws are not properly secured.

Flange mount screws according to ISO 6162-2.

PVB 128 Variant Overview
PVB 128 3-way Compensator

The compensated PVB is intended for controlling a work function where the function behavior in terms of flow and pressures requires independency on the load pressure of other functions used simultaneously.

The compensator is a 3-way type which include load drop check valve functionality, compensator function and neutral relief which avoid A and B port pressure build up in neutral.

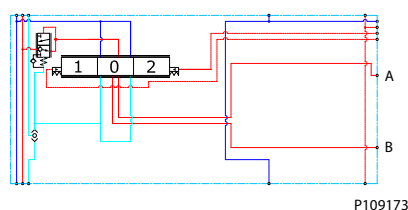
Schematic

Technical data

Max. rated pressure	A/B port continuous	350 bar	[5076 psi]
	A/B port intermittent	400	[5800 psi]
Max. rated flow*	A/B port	300 l/min	[79 US gal/min]
Oil temperature	Recommended	30 to 60°C	[86 to 140°F]
	Minimum	-30°C	[-22°F]
	Maximum	90°	[194°F]
Ambient temperature	Recommended	-30 to 60°C	[-22 to 140°F]
Oil viscosity	Operating range	12 to 75 mm ² /s	[65 to 347 SUS]
	Minimum	4 mm ² /s	[39 SUS]
	Maximum	460 mm ² /s	[2128 SUS]
Oil contamination according to ISO 4406	Maximum	23/19/16	
Max. internal leakage at 100 bar [1450 psi] and 21 mm ² /s [102 SUS]	A/B→T without shock valve	70 cm ³ /min	[4.27 in ³ /min]
	A/B→T with shock valve	80 cm ³ /min	[4.88 in ³ /min]

* Rated flow at 15 bar margin pressure

Part numbers for Compensated PVB 128

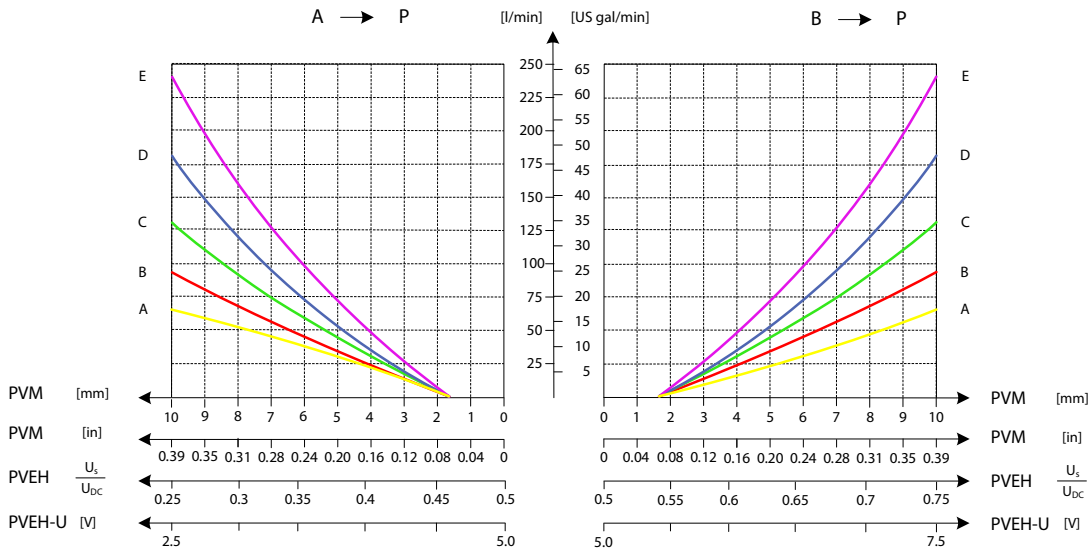
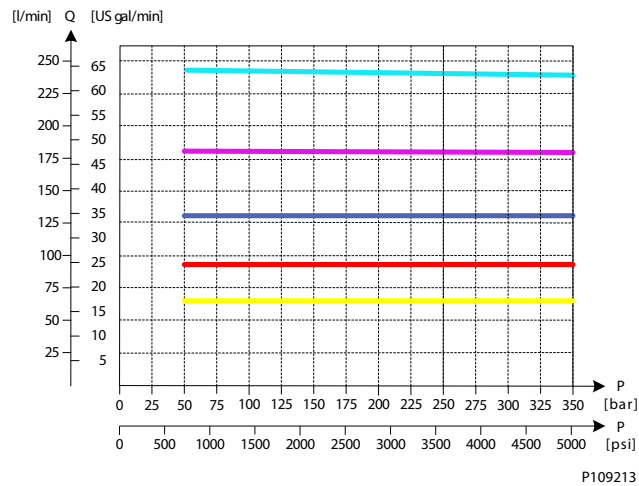
Part number	A/B-port	PVLP/PVLA	LS A/B-port
11170522	Metric Flange 3/4"	-	-
11170528	G 1" BSP	-	-
11170524	SAE Flange 3/4" UNF	-	-
11170526	Thread Ports 1 5/16 UNF	-	-

Technical Information
PVG 128/256 Technical Information
PVB 128 Variant Overview
Oil flow as function of spool travel

Load Independent Oil Flow, Pressure Compensated

PVB 128 Variant Overview

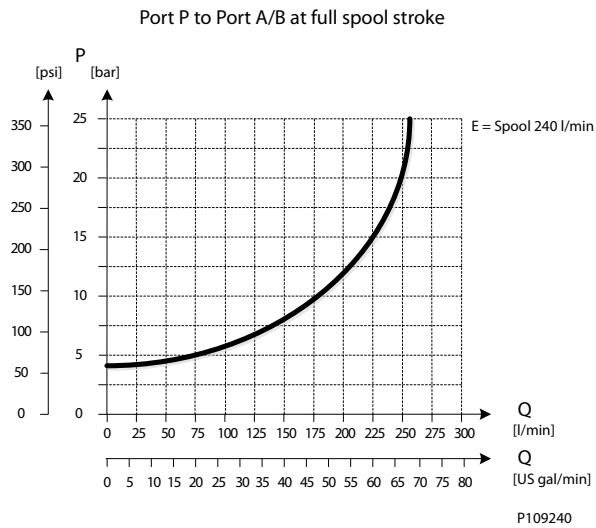
PVB 128 Upstream Performance

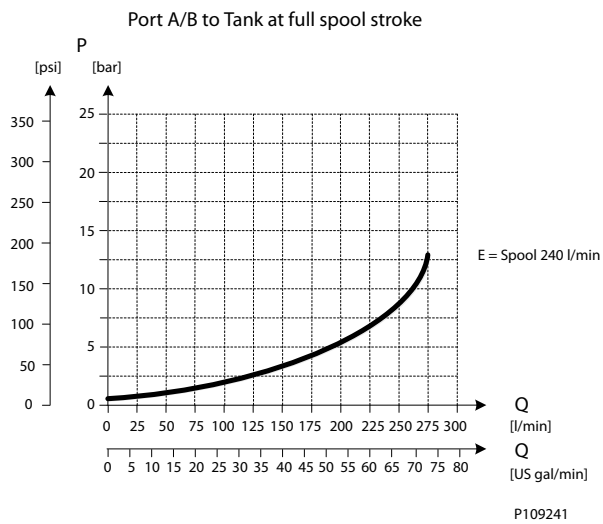

PVB 128 Downstream Performance



PVB 128 Variant Overview
PVB 128 3-way Compensator with LS A/B

The compensated PVB is intended for controlling a work function where the function behavior in terms of flow and pressures requires independency on the load pressure of other functions used simultaneously.

The integrated LSA/B relief valves are used to limit the maximum work port pressure on the A and B-ports individually.

The compensator is a 3-way type which include load drop check valve functionality, compensator function and neutral relief which avoid A and B port pressure build up in neutral.

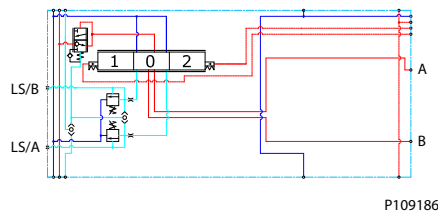
Schematic

Technical data

Max. rated pressure	A/B port continuous	350 bar	[5076 psi]
	A/B port intermittent	400	[5800 psi]
Max. rated flow*	A/B port	300 l/min	[79 US gal/min]
Oil temperature	Recommended	30 to 60°C	[86 to 140°F]
	Minimum	-30°C	[-22°F]
	Maximum	90°	[194°F]
Ambient temperature	Recommended	-30 to 60°C	[-22 to 140°F]
Oil viscosity	Operating range	12 to 75 mm ² /s	[65 to 347 SUS]
	Minimum	4 mm ² /s	[39 SUS]
	Maximum	460 mm ² /s	[2128 SUS]
Oil contamination according to ISO 4406	Maximum	23/19/16	
Max. internal leakage at 100 bar [1450 psi] and 21 mm ² /s [102 SUS]	A/B→T without shock valve	70 cm ³ /min	[4.27 in ³ /min]
	A/B→T with shock valve	80 cm ³ /min	[4.88 in ³ /min]

* Rated flow at 15 bar margin pressure

Part numbers for Compensated PVB with LS A/B

Part number	A/B-port	PVLP/PVLA	LS A/B-port
11176915	Metric Flange 3/4"	-	G1/4"BSP
11176918	G 1" BSP	-	G1/4"BSP
11176916	SAE Flange 3/4" UNF	-	7/16-20 UNF
11176917	Thread Ports 1 5/16 UNF	-	7/16-20 UNF

Technical Information

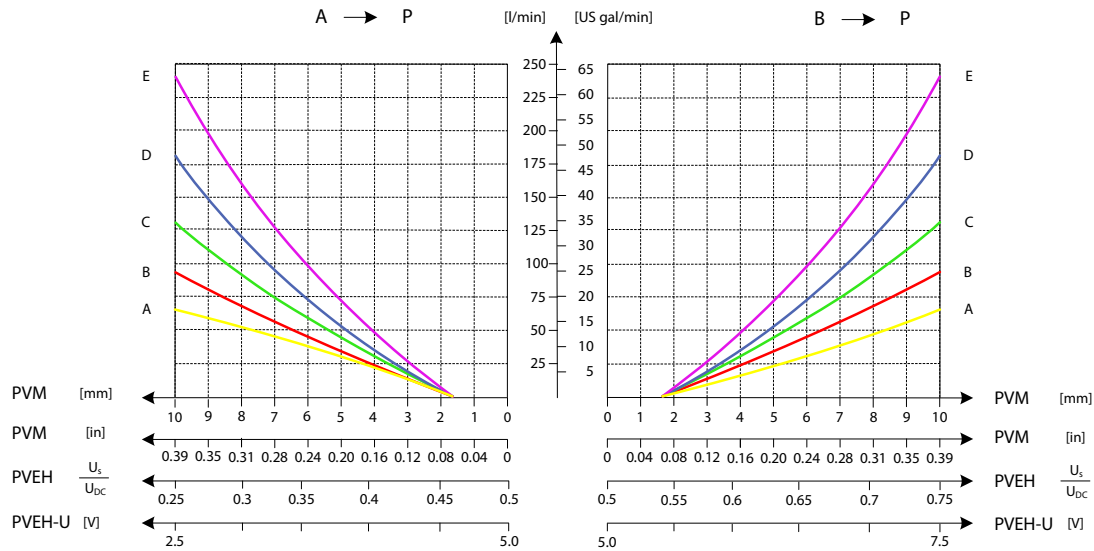
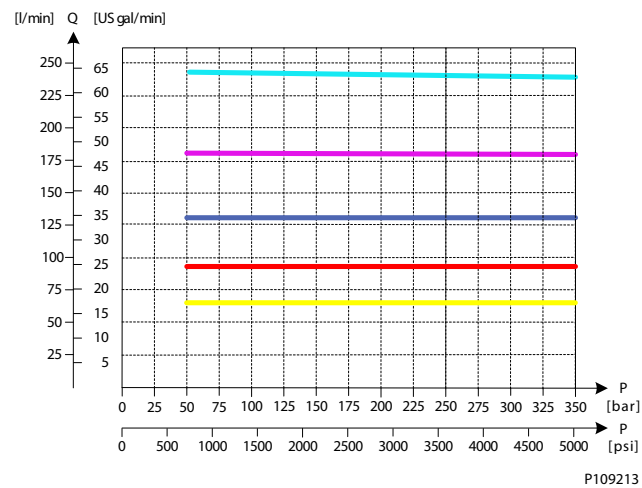
PVG 128/256 Technical Information
PVB 128 Variant Overview
Oil flow as function of spool travel

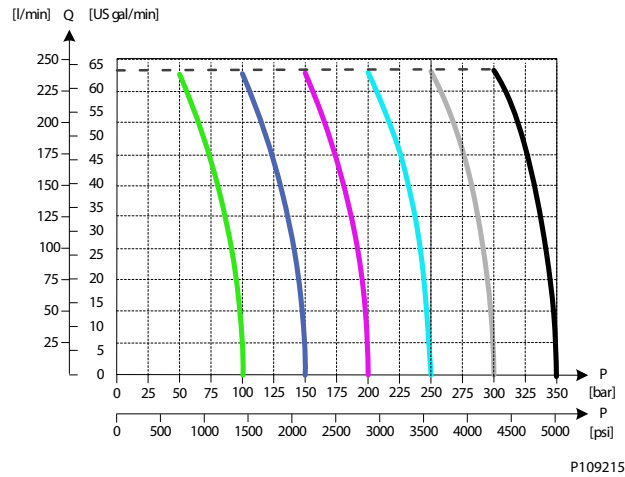
Load Independent Oil Flow, Pressure Compensated

PVB 128 Variant Overview
LS A/B Pressure Relief Valve

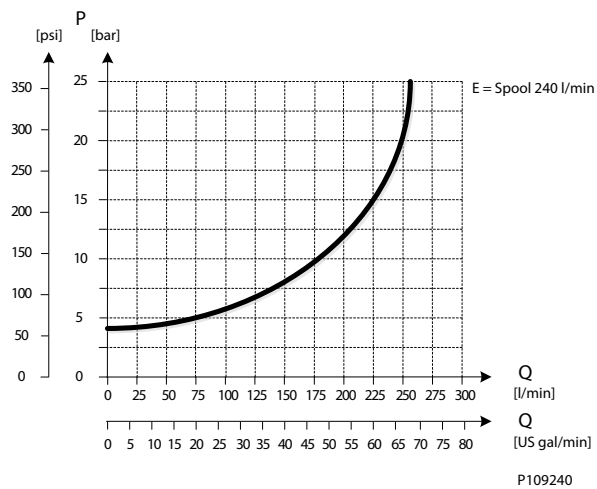
PVB 128 Upstream Performance

Port P to Port A/B at full spool stroke

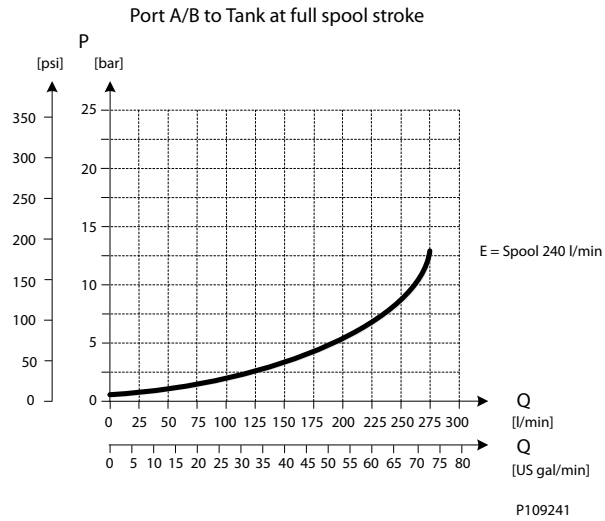

Technical Information

PVG 128/256 Technical Information
PVB 128 Variant Overview
PVB 128 Downstream Performance

PVB 128 Variant Overview
PVB 128 3-way Compensator with LS A/B and PVLP

The compensated PVB is intended for controlling a work function where the function behavior in terms of flow and pressures requires independency on the load pressure of other functions used simultaneously.

The integrated LS A/B relief valves are used to limit the maximum work port pressure on the A and B-ports individually.

Featuring 2xPVLP shock/anti-cavitation valves on each work port for pressure peak protection and anti-cavitation prevention

The compensator is a 3-way type which include load drop check valve functionality, compensator function and neutral relief which avoid A and B port pressure build up in neutral.

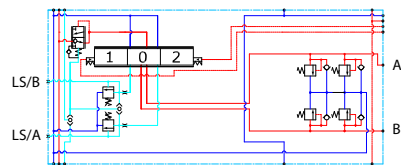
Schematic

P109172

Technical data

Max. rated pressure	A/B port continuous	350 bar	[5076 psi]
	A/B port intermittent	400	[5800 psi]
Max. rated flow*	A/B port	300 l/min	[79 US gal/min]
Oil temperature	Recommended	30 to 60°C	[86 to 140°F]
	Minimum	-30°C	[-22°F]
	Maximum	90°	[194°F]
Ambient temperature	Recommended	-30 to 60°C	[-22 to 140°F]
Oil viscosity	Operating range	12 to 75 mm ² /s	[65 to 347 SUS]
	Minimum	4 mm ² /s	[39 SUS]
	Maximum	460 mm ² /s	[2128 SUS]
Oil contamination according to ISO 4406	Maximum	23/19/16	
Max. internal leakage at 100 bar [1450 psi] and 21 mm ² /s [102 SUS]	A/B→T without shock valve	70 cm ³ /min	[4.27 in ³ /min]
	A/B→T with shock valve	80 cm ³ /min	[4.88 in ³ /min]

* Rated flow at 15 bar margin pressure

Part numbers for Compensated PVB 128 with LSA/B and PVLP

Part number	A/B-port	PVLP/PVLA	LS A/B-port
11165621	Metric Flange 3/4"	2 PVLP/PVLA	G1/4"BSP
11170527	G 1" BSP	2 PVLP/PVLA	G1/4"BSP
11170523	SAE Flange 3/4" UNF	2 PVLP/PVLA	7/16-20 UNF
11170525	Thread Ports 1 5/16 UNF	2 PVLP/PVLA	7/16-20 UNF

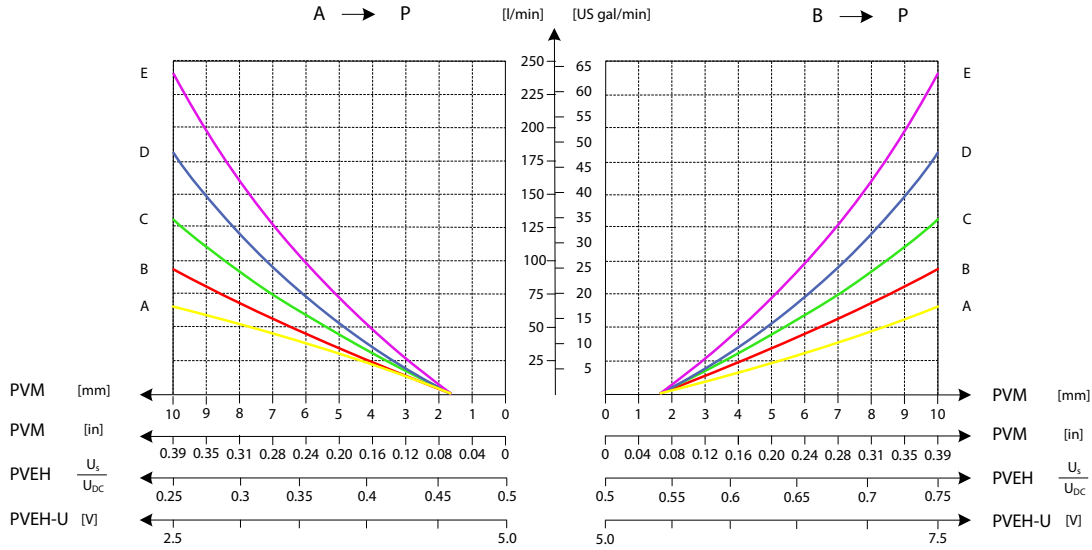
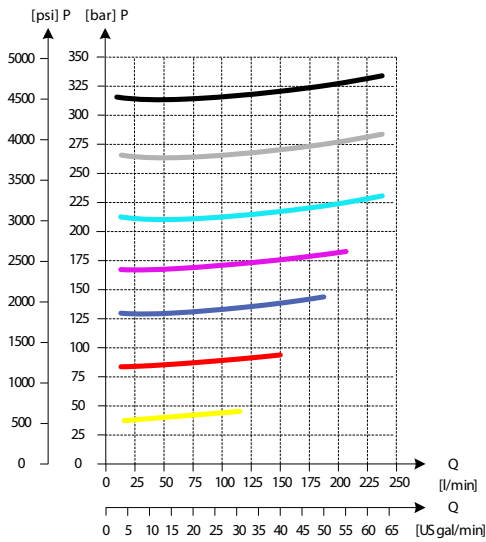
Technical Information
PVG 128/256 Technical Information
PVB 128 Variant Overview
Oil flow as function of spool travel

2xPVLP Shock Valve

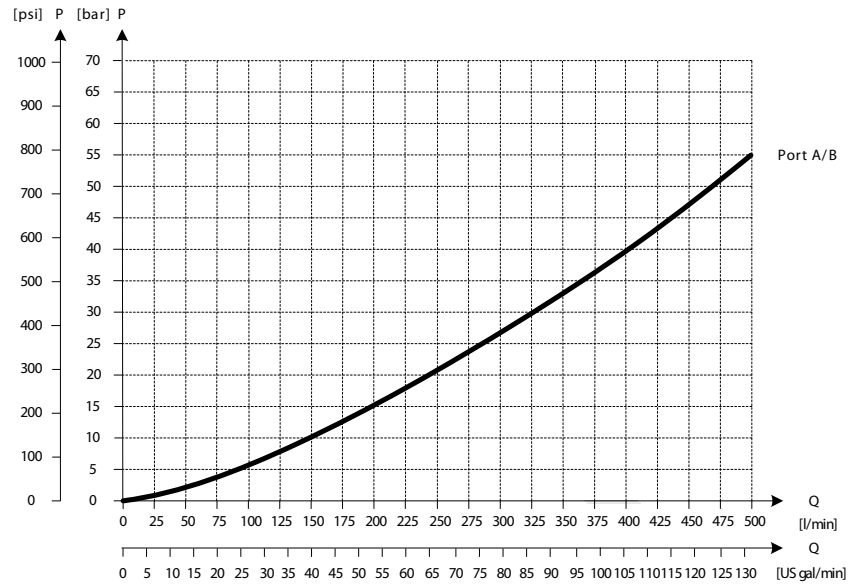
P109216

PVB 128 Variant Overview
2xPVLA Suction Valve

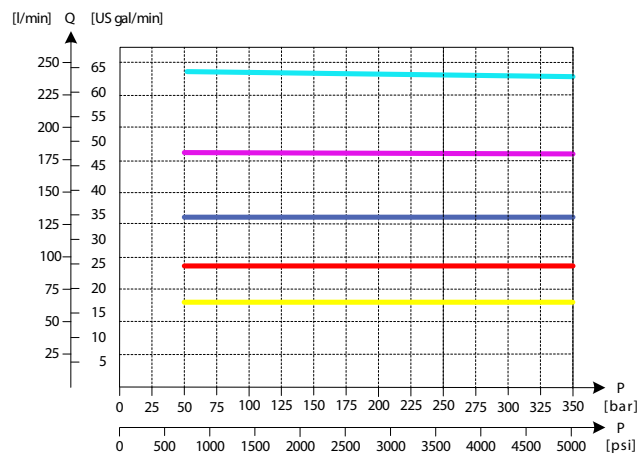
P109217

Load Independent Oil Flow, Pressure Compensated

P109213

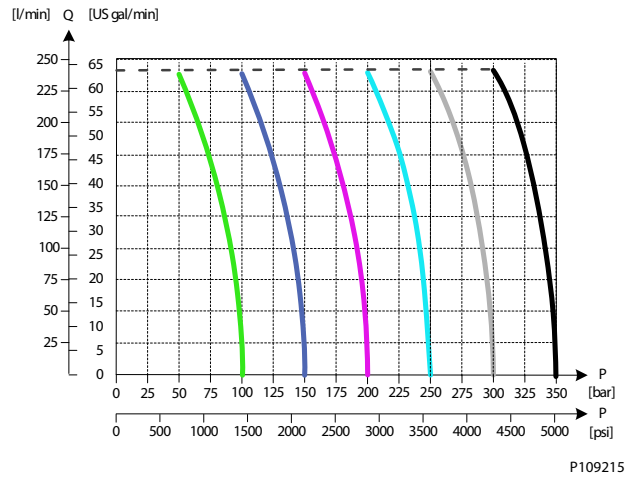
Technical Information
PVG 128/256 Technical Information
PVB 128 Variant Overview
LS A/B Pressure Relief Valve

PVB 128 Upstream Performance

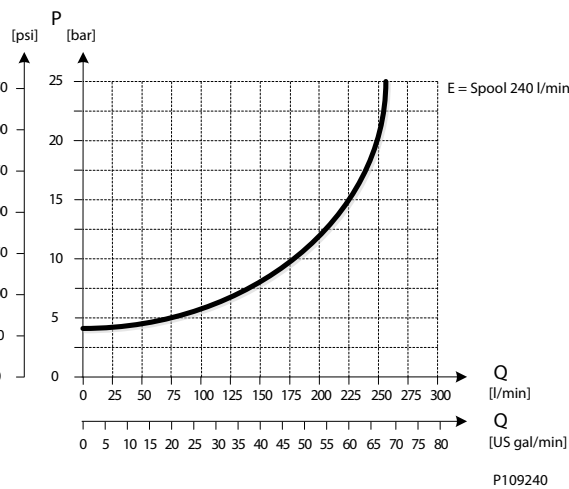
Port P to Port A/B at full spool stroke

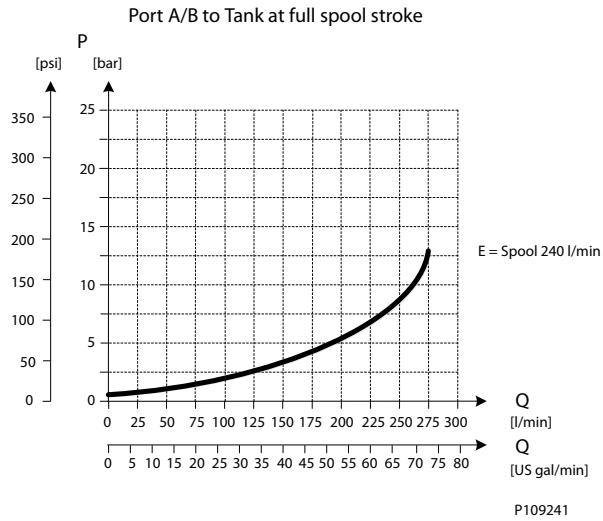

PVB 128 Variant Overview
PVB 128 Downstream Performance

PVB 256 Variant Overview

PVB 256



PVB 256 inlet module dimensions (mm)

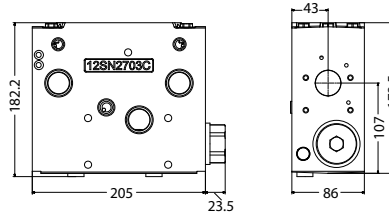

Weight 16 kg [35.3 lbs]

The PVG 256 Basic modules (PVB), also referred to as work sections, is the interface between the PVG 256 proportional valve group and the work function such as a cylinder or a motor.

The PVB basic module variants are based on a generic platform with a selection of additional features, enabling you to tailor the PVB to suit the demands of any hydraulic system.

The compensator is a 3-way type which includes load drop check valve functionality, compensator function and neutral relief which avoid A and B port pressure build up.

The generic PVB basic module platform includes the following main variants.

[Compensated PVB 256](#) Compensated basic module.

[Compensated PVB 256 with LS A/B](#) Compensated basic module with LSA/B relief valve for each work port.

[Compensated PVB 256 with LS A/B and PVLP](#) Compensated basic module with LSA/B relief valve for each work port and 3xPVLPs for each work port.

[Compensated PVB 256 with Turbo compensator feature](#) Compensated basic module with LS A/B relief valve for each work port and 3xPVLPs for each work port.

PVB 256 Variant Overview
PVB 256 3-way Compensator

The compensated PVB is intended for controlling a work function where the function behavior in terms of flow and pressures requires independency on the load pressure of other functions used simultaneously.

The integrated LS A/B relief valves are used to limit the maximum work port pressure on the A and B-ports individually.

The compensator is a 3-way type which include load drop check valve functionality, compensator function and neutral relief which avoid A and B port pressure build up in neutral.

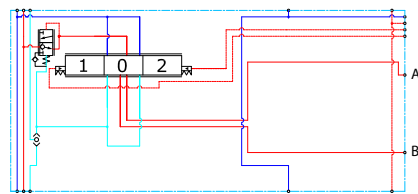
Schematic

P109168

Technical data

Max. rated pressure	A/B port continuous	350 bar	[5076 psi]
	A/B port intermittent	400 bar	[5800 psi]
Max. rated flow	A/B port	400 l/min	[106 US gal/min]
Oil temperature	Recommended	30 to 60°C	[86 to 140°F]
	Minimum	-30°C	[-22°F]
	Maximum	90°	[194°F]
Ambient temperature	Recommended	-30 to 60°C	[-22 to 140°F]
Oil viscosity	Operating range	12 to 75 mm ² /s	[65 to 347 SUS]
	Minimum	4 mm ² /s	[39 SUS]
	Maximum	460 mm ² /s	[2128 SUS]
Oil contamination according to ISO 4406	Maximum	23/19/16	
Max. internal leakage at 100 bar [1450 psi] and 21 mm ² /s [102 SUS]	A/B→T without shock valve	70 cm ³ /min	[4.27 in ³ /min]
	A/B→T with shock valve	85 cm ³ /min	[5.19 in ³ /min]

Part numbers for Compensated PVB 256

Part number	A/B port	PVLP/PVLA	LS A/B port
11169244	Metric Flange 1-1/4"	-	-
11169252	G1-1/4" BSP	-	-
11169248	SAE Flange 1-1/4" UNF	-	-
11177020	Thread Ports 1-1/4 UNF	-	-

Technical Information

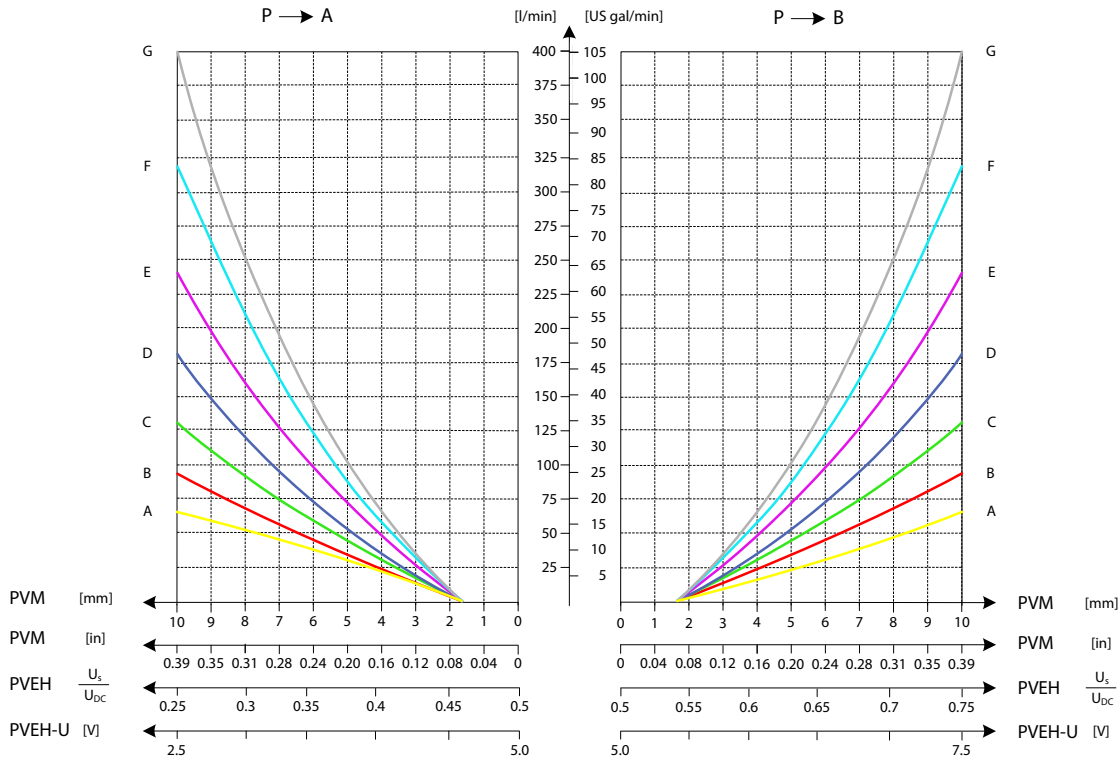
PVG 128/256 Technical Information
PVB 256 Variant Overview
Oil Flow as Function of Spool Travel

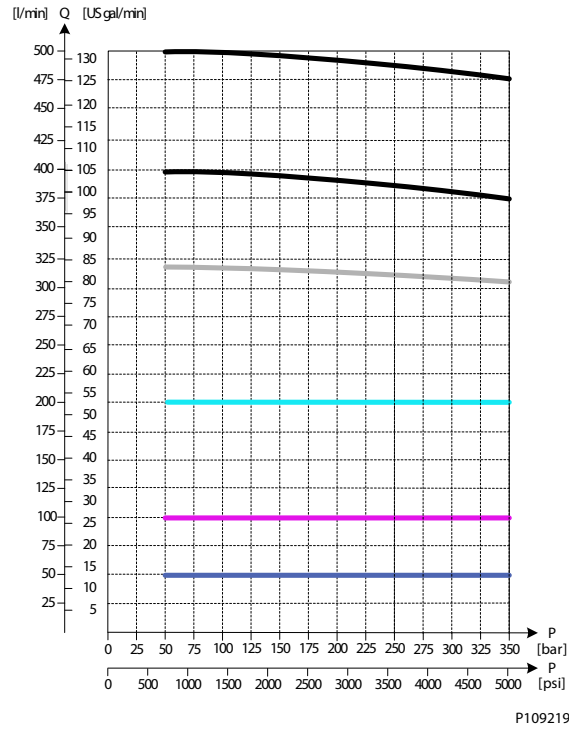
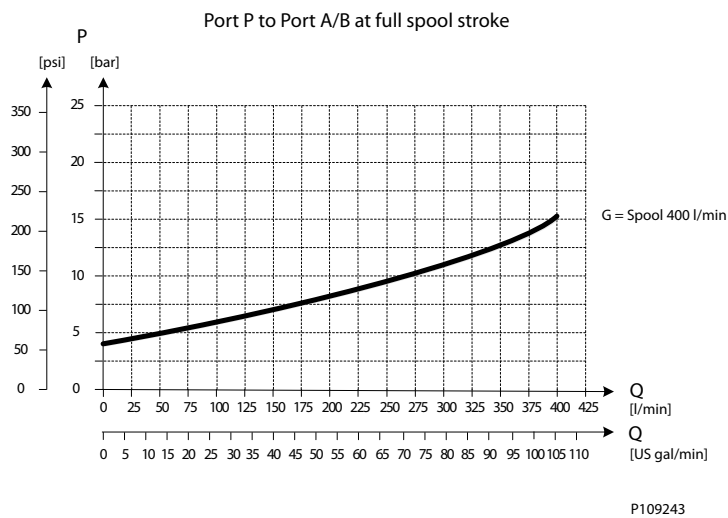
PVB 256 Variant Overview
Load Independent Oil Flow, Pressure Compensated

PVB 256 Upstream Performance

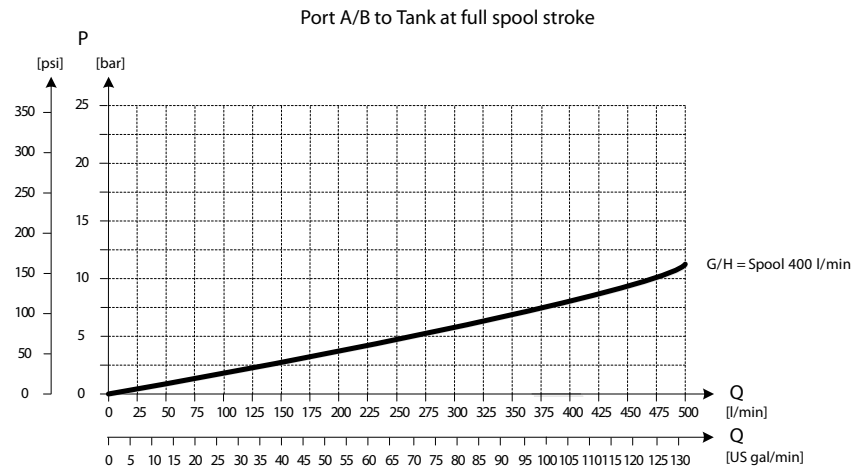
Technical Information

PVG 128/256 Technical Information
PVB 256 Variant Overview
PVB 256 Downstream Performance

P109244

Technical Information
PVG 128/256 Technical Information
PVB 256 Variant Overview
PVB 256 3-way Compensator with LS A/B

The compensated PVB is intended for controlling a work function where the function behavior in terms of flow and pressures requires independency on the load pressure of other functions used simultaneously.

The integrated LS A/B relief valves are used to limit the maximum work port pressure on the A and B-ports individually.

The compensator is a 3-way type which include load drop check valve functionality, compensator function and neutral relief which avoid A and B port pressure build up in neutral.

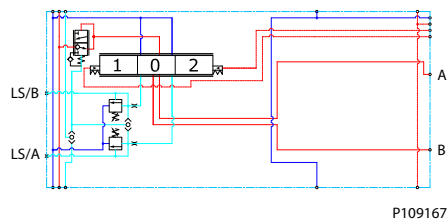
Schematic

Technical data

Max. rated pressure	A/B port continuous	350 bar	[5076 psi]
	A/B port intermittent	400	[5800 psi]
Max. rated flow	A/B port	400 l/min	[106 US gal/min]
Oil temperature	Recommended	30 to 60°C	[86 to 140°F]
	Minimum	-30°C	[-22°F]
	Maximum	90°	[194°F]
Ambient temperature	Recommended	-30 to 60°C	[-22 to 140°F]
Oil viscosity	Operating range	12 to 75 mm ² /s	[65 to 347 SUS]
	Minimum	4 mm ² /s	[39 SUS]
	Maximum	460 mm ² /s	[2128 SUS]
Oil contamination according to ISO 4406	Maximum	23/19/16	
Max. internal leakage at 100 bar [1450 psi] and 21 mm ² /s [102 SUS]	A/B→T without shock valve	70 cm ³ /min	[4.27 in ³ /min]
	A/B→T with shock valve	85 cm ³ /min	[5.19 in ³ /min]

Part numbers for Compensated PVB 256 with LSA/B

Part number	A/B-port	PVLP/PVLA	LS A/B-port
11177015	Metric Flange 1-1/4"	-	G1/4"BSP
11177017	G1-1/4" BSP	-	G1/4"BSP
11177016	SAE Flange 1-1/4" UNF	-	7/16-20 UNF
11177019	Thread Ports 1-1/4 UNF	-	7/16-20 UNF

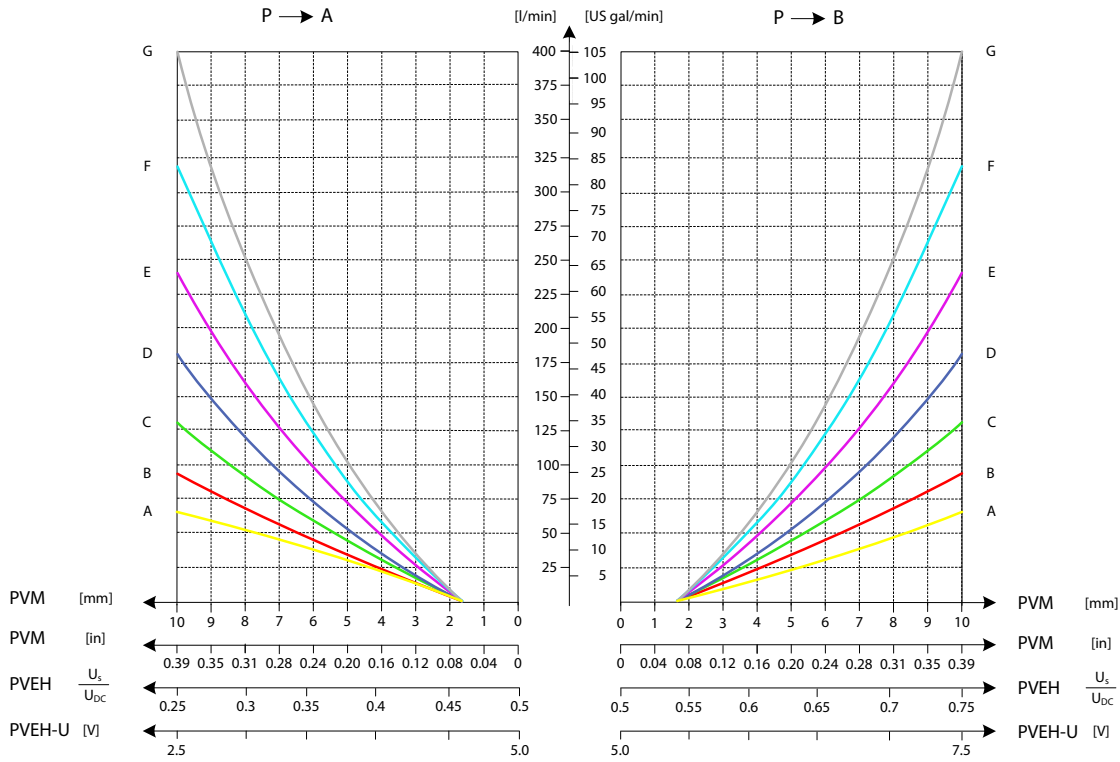
Technical Information

PVG 128/256 Technical Information
PVB 256 Variant Overview
Oil Flow as Function of Spool Travel



Technical Information

PVG 128/256 Technical Information

PVB 256 Variant Overview

Load Independent Oil Flow, Pressure Compensated

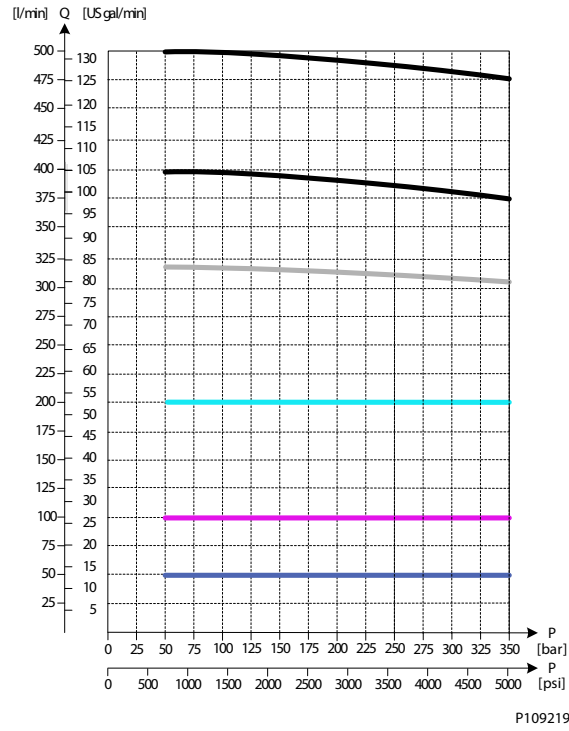

LS A/B Pressure Limitation

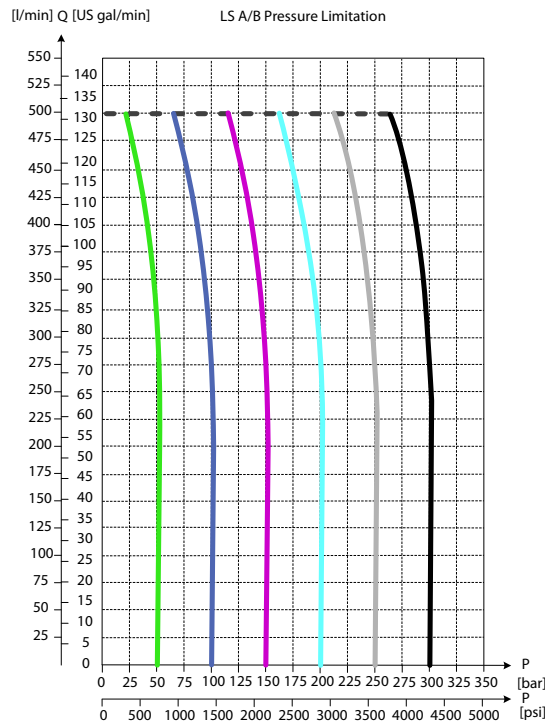

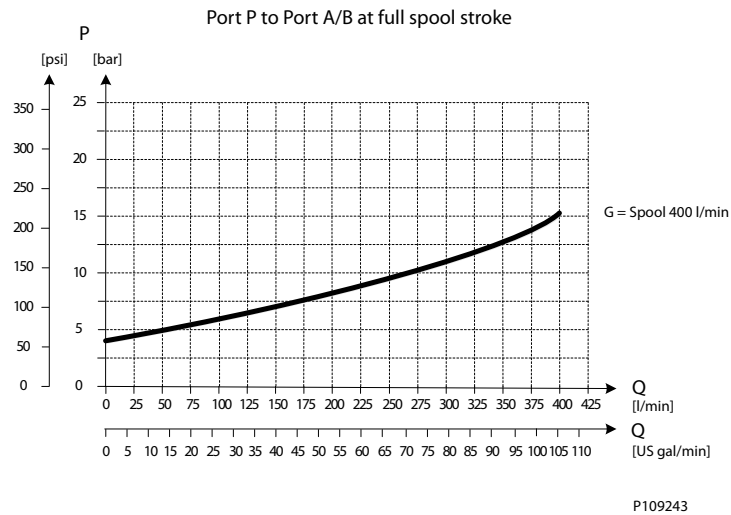
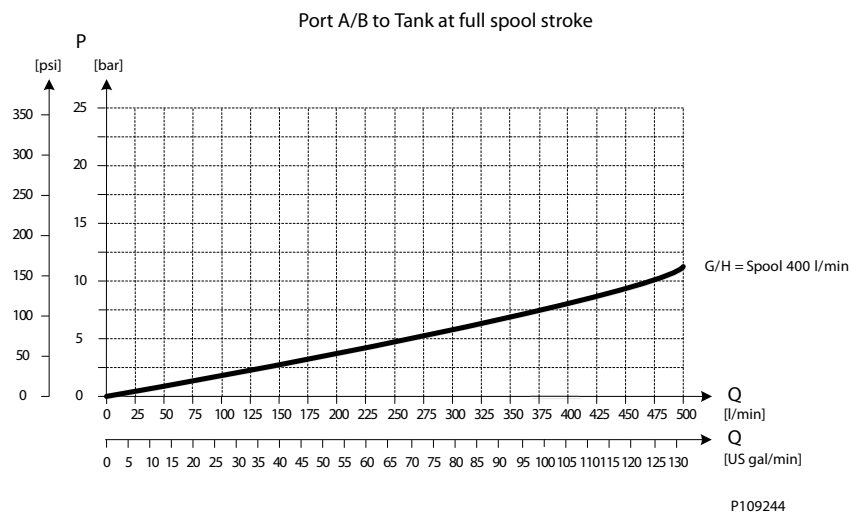
PVB 256 Variant Overview
PVB 256 Upstream Performance

PVB 256 Downstream Performance

PVB 256 Variant Overview
PVB 256 3-way Compensator with LSA/B and PVLP

The compensated PVB is intended for controlling a work function where the function behavior in terms of flow and pressures requires independency on the load pressure of other functions used simultaneously.

The integrated LS A/B relief valves are used to limit the maximum work port pressure on the A and B-ports individually.

Featuring 3xPVLP shock/anti-cavitation valves on each work port for pressure peak protection and anti-cavitation prevention.

The compensator is a 3-way type which include load drop check valve functionality, compensator function and neutral relief which avoid A and B port pressure build up in neutral.

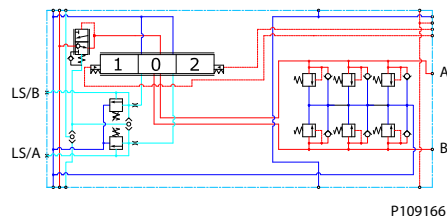

Technical data

Max. rated pressure	A/B port continuous	350 bar	[5076 psi]
	A/B port intermittent	400 bar	[5800 psi]
Max. rated flow	A/B port	400 l/min	[106 US gal/min]
Oil temperature	Recommended	30 to 60°C	[86 to 140°F]
	Minimum	-30°C	[-22°F]
	Maximum	90°	[194°F]
Ambient temperature	Recommended	-30 to 60°C	[-22 to 140°F]
Oil viscosity	Operating range	12 to 75 mm ² /s	[65 to 347 SUS]
	Minimum	4 mm ² /s	[39 SUS]
	Maximum	460 mm ² /s	[2128 SUS]
Oil contamination according to ISO 4406	Maximum	23/19/16	
Max. internal leakage at 100 bar [1450 psi] and 21 mm ² /s [102 SUS]	A/B→T without shock valve	70 cm ³ /min	[4.27 in ³ /min]
	A/B→T with shock valve	85 cm ³ /min	[5.19 in ³ /min]

Part numbers for Compensated PVB 256 with LSA/B and PVLP

Part number	A/B port	PVLP/PVLA	LS A/B port
11169243	Metric Flange 1-1/4"	3 PVLP/PVLA	G1/4"BSP
11169251	G1-1/4" BSP	3 PVLP/PVLA	G1/4"BSP
11169247	SAE Flange 1-1/4" UNF	3 PVLP/PVLA	7/16-20 UNF
11177018	Thread Ports 1-1/4 UNF	3 PVLP/PVLA	7/16-20 UNF

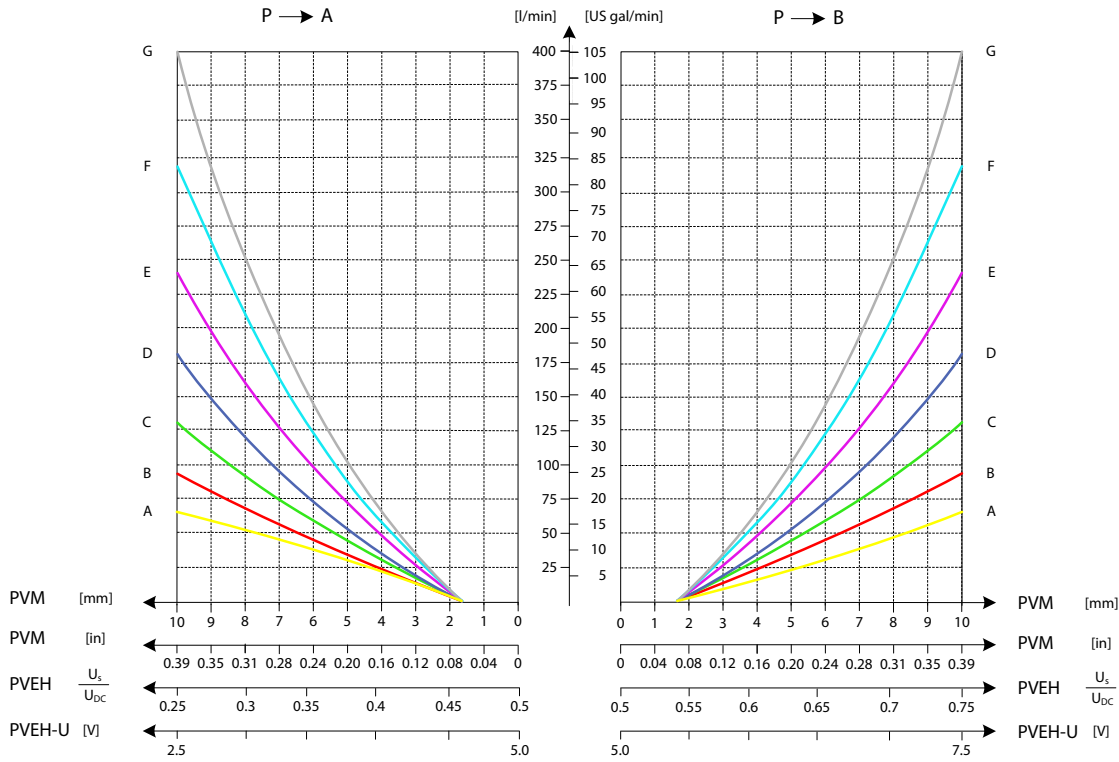
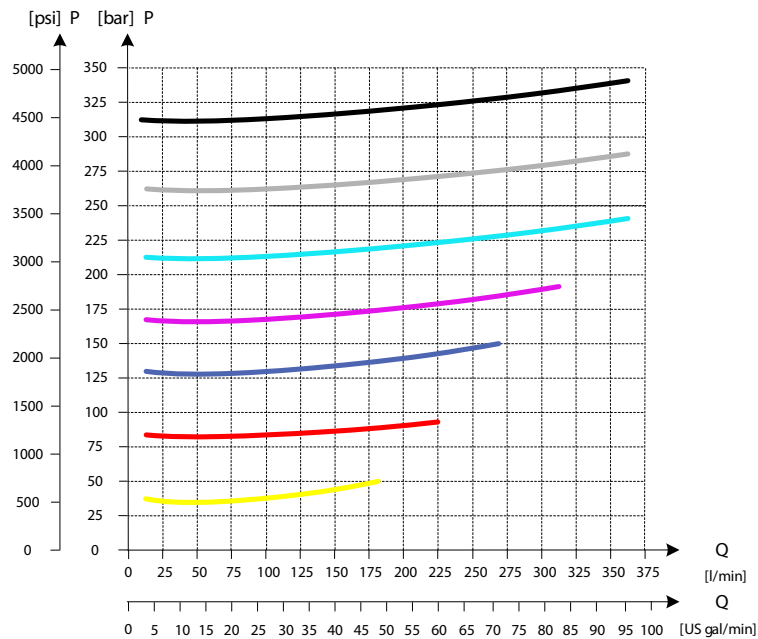
Technical Information

PVG 128/256 Technical Information
PVB 256 Variant Overview
Oil Flow as Function of Spool Travel

3xPVL Shock Valve

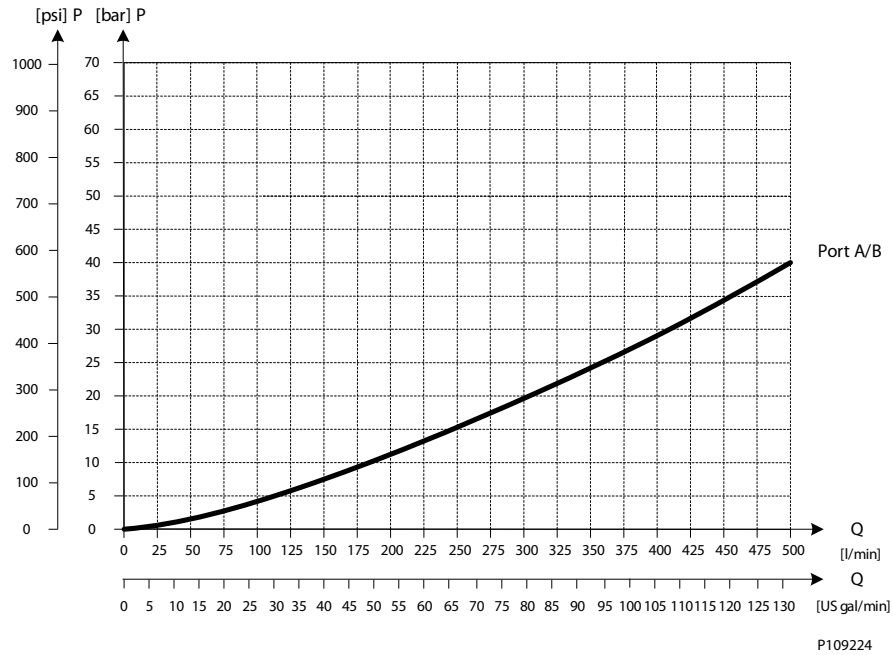
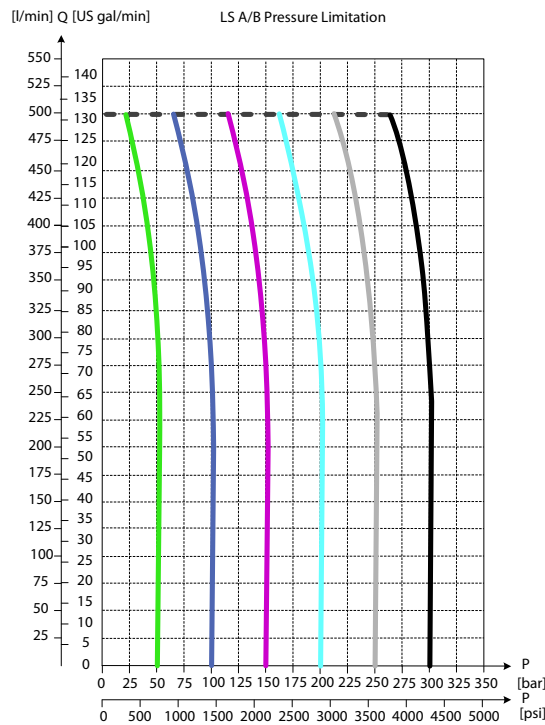
P109221

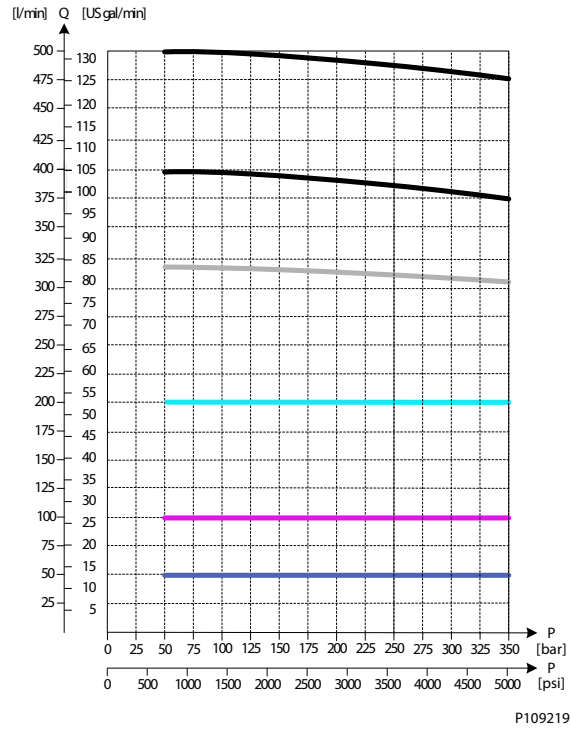
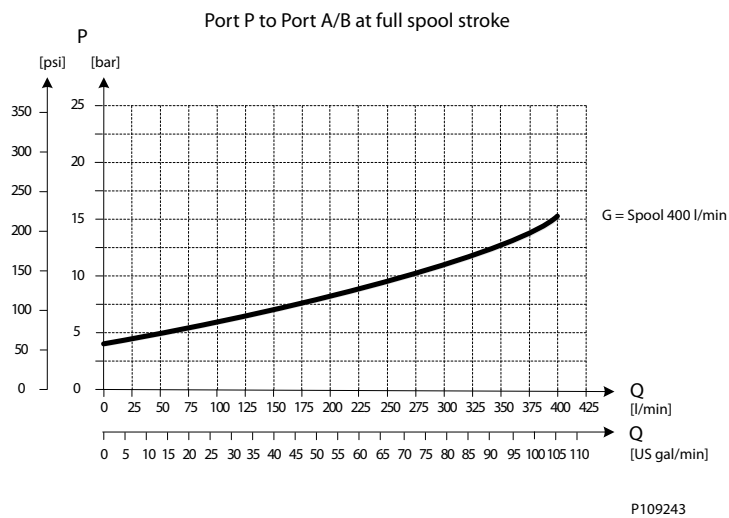
PVB 256 Variant Overview
3xPVLA Suction Valve

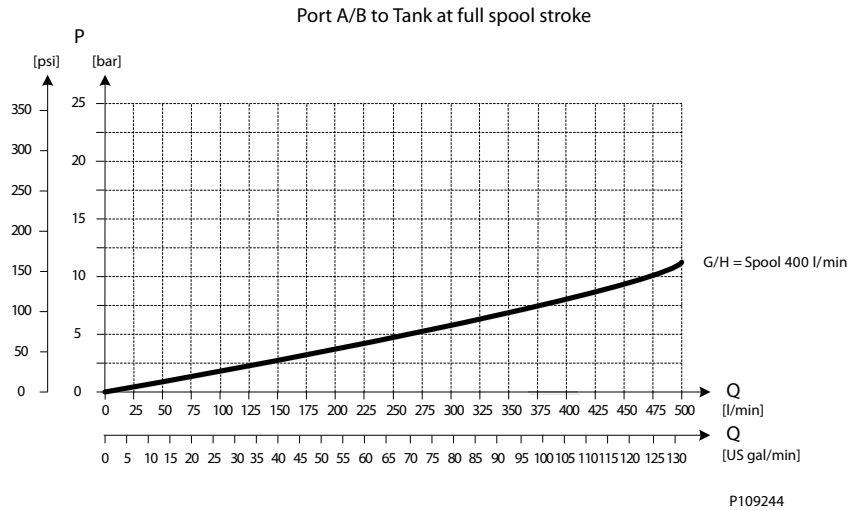
LS A/B Pressure Limitation

Technical Information
PVG 128/256 Technical Information
PVB 256 Variant Overview
Load Independent Oil Flow, Pressure Compensated

PVB 256 Upstream Performance

PVB 256 Variant Overview
PVB 256 Downstream Performance

PVB 256 Variant Overview
PVB 256 3-way Compensator with LS A/B, PVLP and Turbo

The compensated PVB is intended for controlling a work function where the function behavior in terms of flow and pressures requires independency on the load pressure of other functions used simultaneously.

The integrated LS A/B relief valves are used to limit the maximum work port pressure on the A and B-ports individually.

Featuring 3xPVLP shock/anti-cavitation valves on each work port for pressure peak protection and anti-cavitation prevention.

The compensator is a 3-way type which include load drop check valve functionality, compensator function and neutral relief which avoid A and B port pressure build up in neutral.

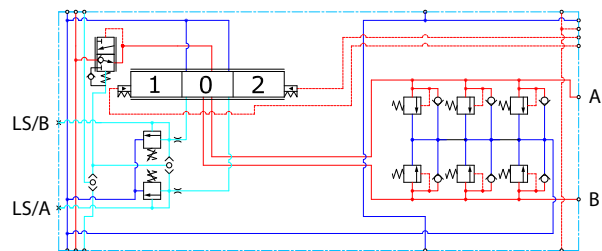
Schematic

P109169

Technical data

Max. rated pressure	A/B port continuous	350 bar	[5076 psi]
	A/B port intermittent	400 bar	[5800 psi]
Max. rated flow	A/B port	400 l/min	[106 US gal/min]
Oil temperature	Recommended	30 to 60°C	[86 to 140°F]
	Minimum	-30°C	[-22°F]
	Maximum	90°	[194°F]
Ambient temperature	Recommended	-30 to 60°C	[-22 to 140°F]
Oil viscosity	Operating range	12 to 75 mm ² /s	[65 to 347 SUS]
	Minimum	4 mm ² /s	[39 SUS]
	Maximum	460 mm ² /s	[2128 SUS]
Oil contamination according to ISO 4406	Maximum	23/19/16	
Max. internal leakage at 100 bar [1450 psi] and 21 mm ² /s [102 SUS]	A/B→T without shock valve	70 cm ³ /min	[4.27 in ³ /min]
	A/B→T with shock valve	85 cm ³ /min	[5.19 in ³ /min]

Part numbers for Compensated PVB 256 with LSA/B, PVLP and Turbo

Part number	A/B port	PVLP/PVLA	LS A/B port
11183379	Metric Flange 1-1/4"	3 PVLP/PVLA	G1/4"BSP
11183406	G1-1/4" BSP	3 PVLP/PVLA	G1/4"BSP
11183404	SAE Flange 1-1/4" UNF	3 PVLP/PVLA	7/16-20 UNF
11183402	Thread Ports 1-1/4 UNF	3 PVLP/PVLA	7/16-20 UNF

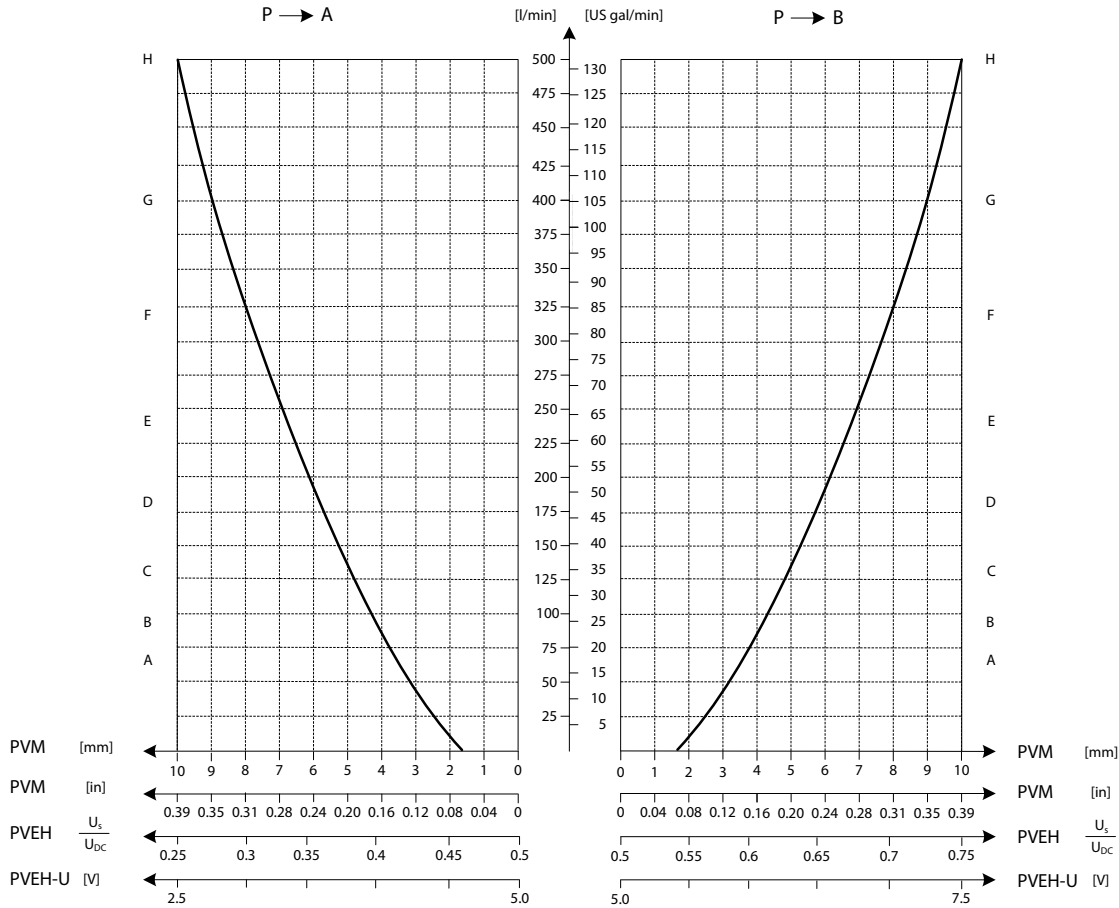
PVB 256 Variant Overview
Oil Flow as Function of Spool Travel

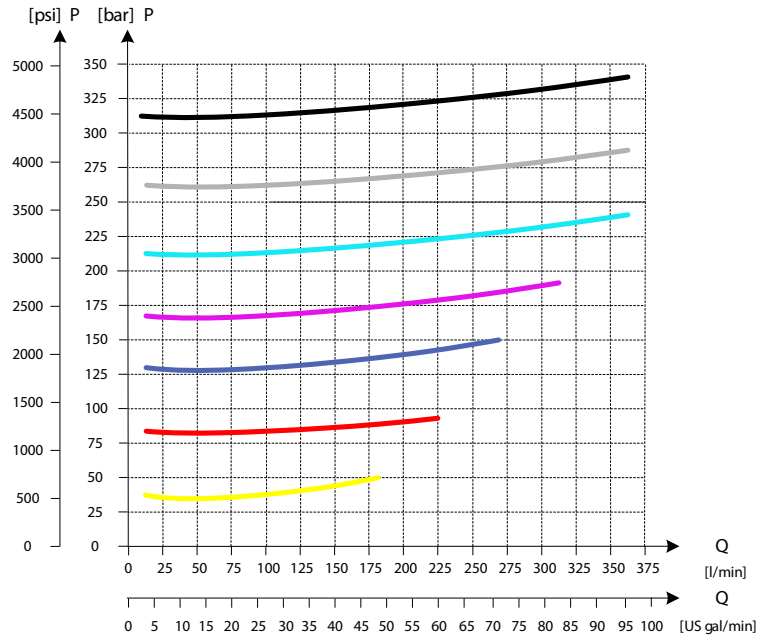
PVB 256 Variant Overview
3xPVL P Shock Valve

P109221

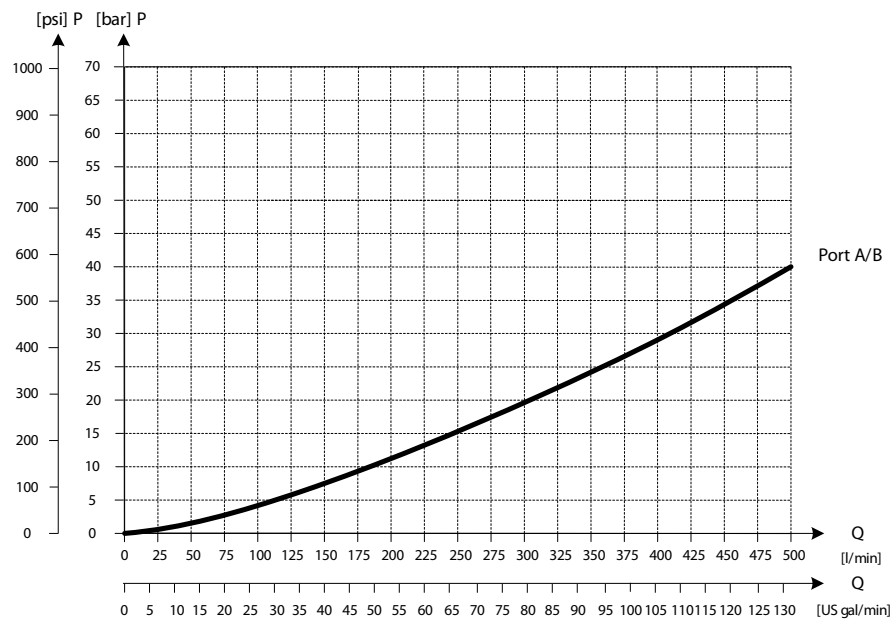
3xPVL A Suction Valve

P109224



Technical Information

PVG 128/256 Technical Information

PVB 256 Variant Overview

LS A/B Pressure Limitation

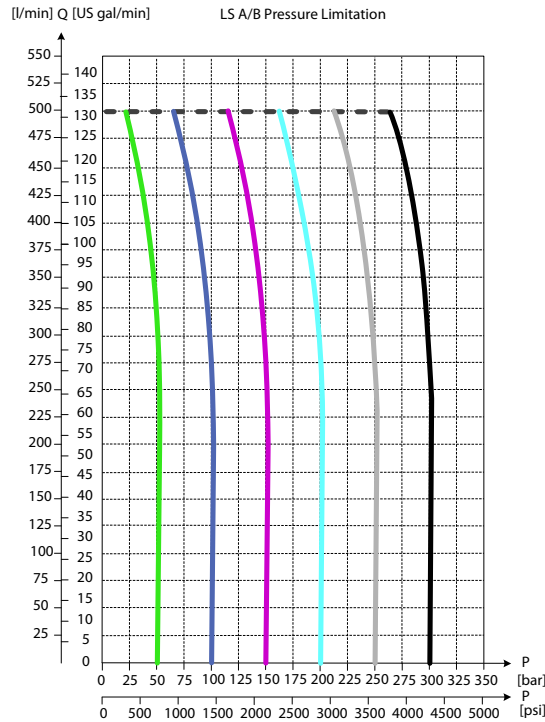

Load Independent Oil Flow, Pressure Compensated

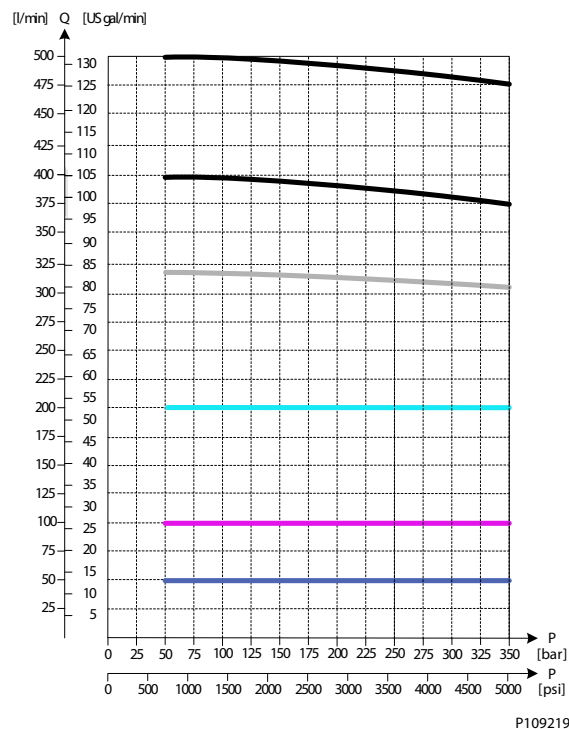

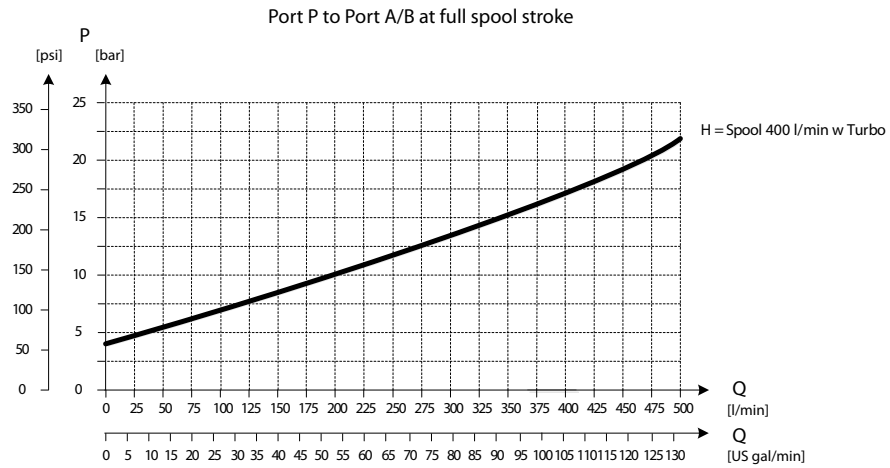
PVB 256 Variant Overview
PVB 256 Turbo Upstream Performance

P109245

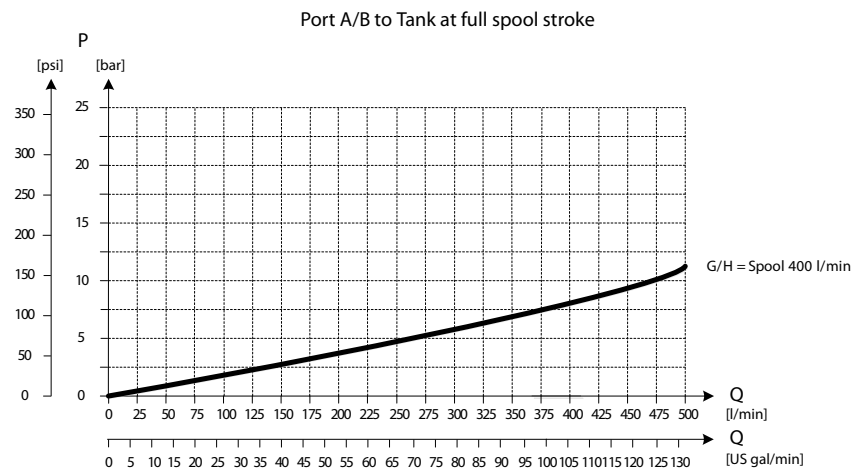
PVB 256 Downstream Performance

P109244

PVLP Shock and PVLA Suction Valves
PVLP Overview

PVLP is set at an oil flow of 10 l/min [2.6 US gal/min] per unit.

The shock valve PVLP is designed to absorb shock effects. Consequently, it should not be used as a pressure relief valve.

If the working function requires the use of a pressure relief valve, a PVB basic module with built-in LSA/B pressure limiting valve should be used.

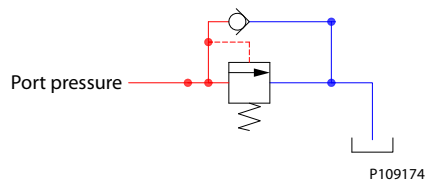
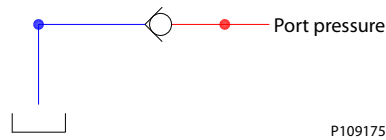
PVLP schematic

PVLA schematic

PVLP Technical Data
Technical data

Oil temperature	Recommended	30 to 60°C	[86 to 140°F]
	Minimum	-30°C	[-22°F]
	Maximum	90°	[194°F]
Ambient temperature	Recommended	-30 to 60°C	[-22 to 140°F]
Oil viscosity	Operating range	12 to 75 mm ² /s	[65 to 347 SUS]
	Minimum	4 mm ² /s	[39 SUS]
	Maximum	460 mm ² /s	[2128 SUS]
Oil contamination according to ISO 4406	Maximum	23/19/16	

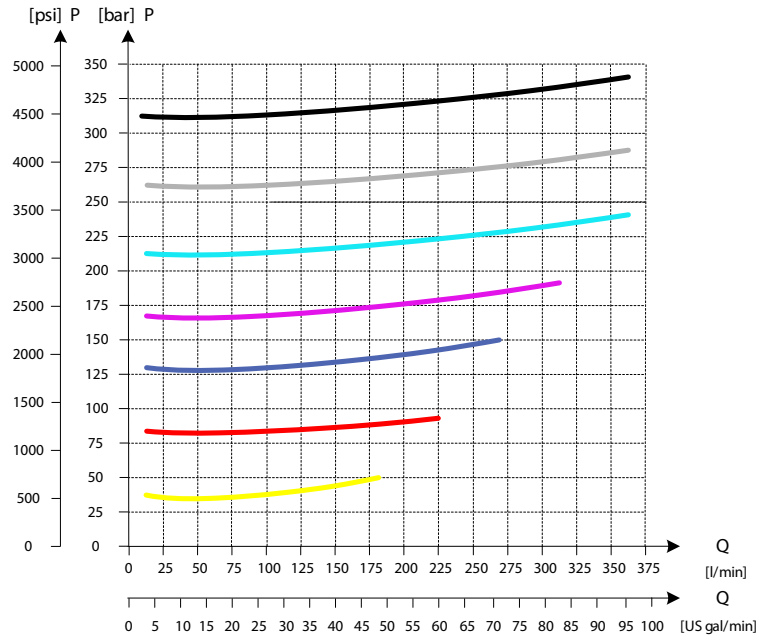
PVLP Shock and PVLA Suction Valves
Part numbers for PVLP Shock and PVLA Suction Valves

Description	Pressure setting in bar	Part number
PVLA	-	157B2001
PVLP	32	157B2032
	50	157B2050
	63	157B2063
	80	157B2080
	100	157B2100
	125	157B2125
	140	157B2140
	150	157B2150
	160	157B2160
	175	157B2175
	190	157B2190
	210	157B2210
	230	157B2230
	240	157B2240
	250	157B2250
	265	157B2265
	280	157B2280
300	157B2300	
320	157B2320	
350	157B2350	
380	157B2380	
PLUG	-	157B2002

PVLP Shock and PVLA Suction Valves
3xPVLP Shock Valve

P109221

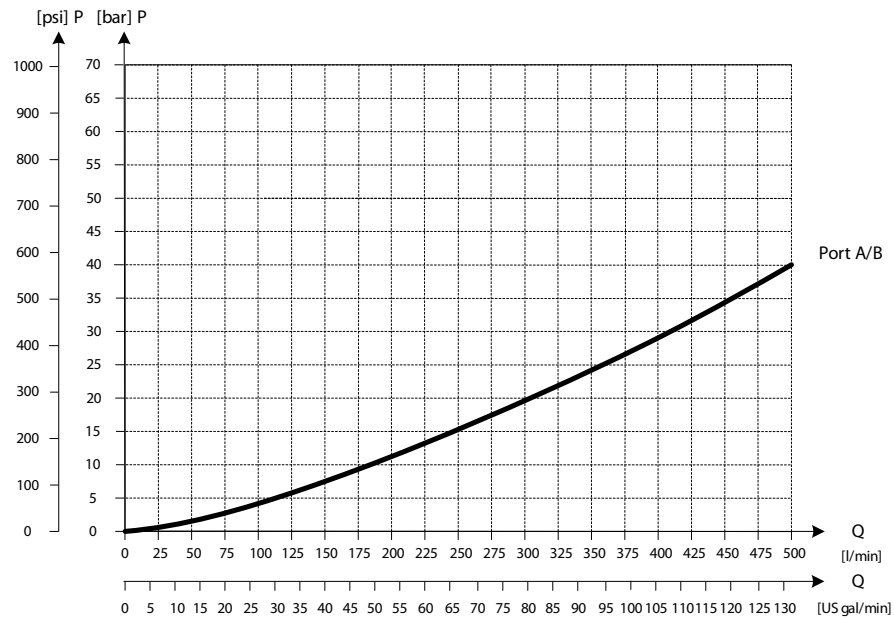
3xPVLA Suction Valve

P109224

PVBS Main Spool

The PVG 128/256 main spools (PVBS) determines the flow out of the work section.

The PVBS main spool variants are based on a generic platform with a wide selection of additional features, enabling you to tailor the PVBS to suit the demands of any hydraulic system and any function.

The PVBS main spool can be activated in three different ways:

- Mechanically by a PVM lever
- Electrically by either a PVE or a PVHC actuator
- Hydraulically by a PVH actuator

All spools can be mechanically activated.

PVBS Main Spool

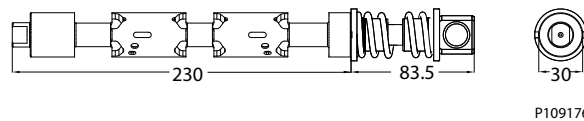

PVBS Main Spool dimensions

PVBS Main Spools variant overview
Flow control spools

- Flow control spool closed neutral position
- Flow control spool throttled open neutral position
- Single acting cylinder flow control spool closed neutral position, flow control B port
- Flow control spool closed neutral position with A-float

PVBS main spools product details
Technical data

Oil temperature	Recommended	30 to 60°C	[86 to 140°F]
	Minimum	-30°C	[-22°F]
	Maximum	90°	[194°F]
Ambient temperature	Recommended	-30 to 60°C	[-22 to 140°F]
Oil viscosity	Operating range	12 to 75 mm ² /s	[65 to 347 SUS]
	Minimum	4 mm ² /s	[39 SUS]
	Maximum	460 mm ² /s	[2128 SUS]
Oil contamination according to ISO 4406	Maximum	23/19/16	

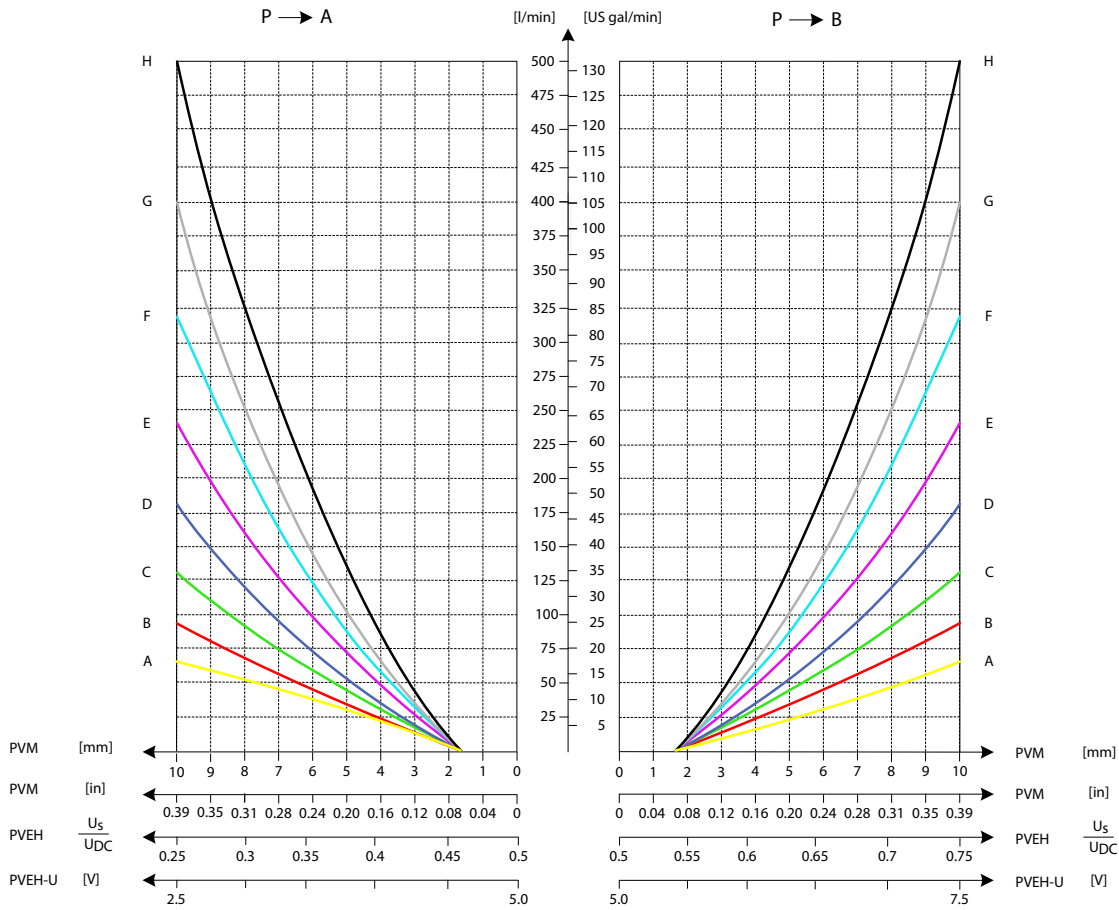
Technical Information
PVG 128/256 Technical Information
PVBS Main Spool
Progressive Oil Flow as Function of Spool Travel

Technical Information

PVG 128/256 Technical Information

PVBS Main Spool

Pressure drop for open spool in neutral position

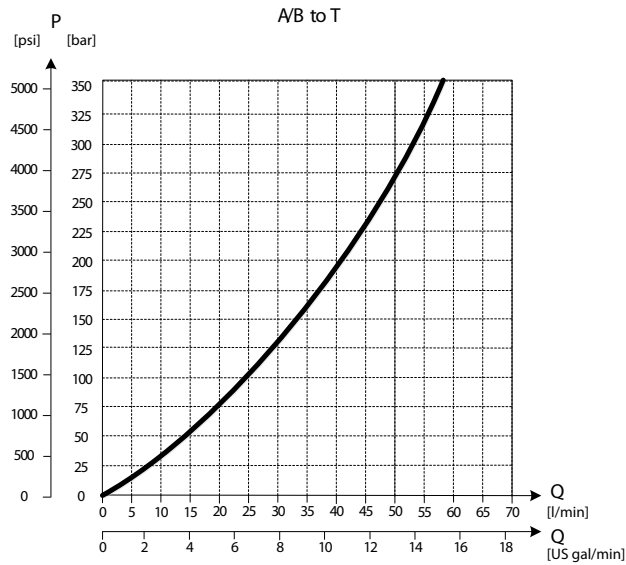

P109253

Progressive oil flow characteristic of spool with A-float

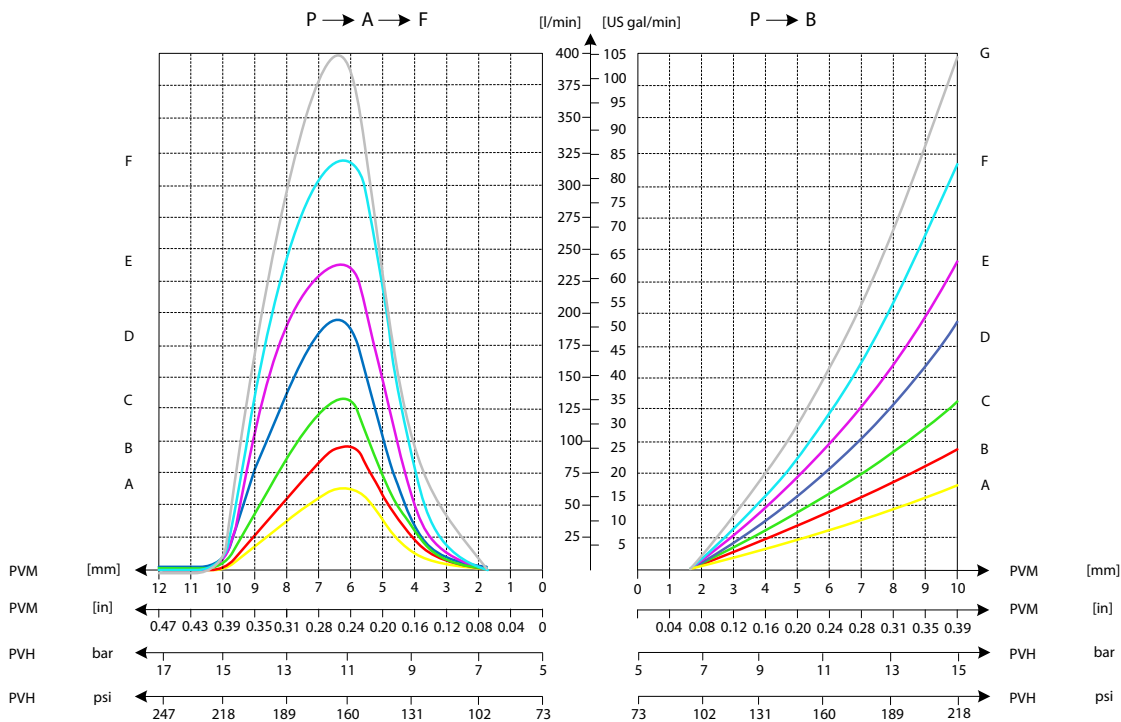

PVS Main spools part numbers

PVBS Main Spool
Flow control spools
Flow control spool closed neutral position

Schematic

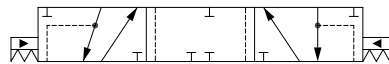

P109177

Symmetric flow control spools

Part number	Actuation	Flow - l/min (US gal/min)			
		A→T	P→A	P→B	B→T
11177686	PVE	65 [17.17]	65 [17.17]	65 [17.17]	65 [17.17]
11177738	PVE	95 [25.10]	95 [25.10]	95 [25.10]	95 [25.10]
11177750	PVE	130 [34.34]	130 [34.34]	130 [34.34]	130 [34.34]
11177448	PVE	180 [47.55]	180 [47.55]	180 [47.55]	180 [47.55]
11177798	PVE	240 [63.40]	240 [63.40]	240 [63.40]	240 [63.40]
11178733	PVE	320 [84.54]	320 [84.54]	320 [84.54]	320 [84.54]
11177058*	PVE	400 [105.67]	400 [105.67]	400 [105.67]	400 [105.67]
11184159	PVH/PVHC	65 [17.17]	65 [17.17]	65 [17.17]	65 [17.17]
11184846	PVH/PVHC	95 [25.10]	95 [25.10]	95 [25.10]	95 [25.10]
11182643	PVH/PVHC	130 [34.34]	130 [34.34]	130 [34.34]	130 [34.34]
11182640	PVH/PVHC	180 [47.55]	180 [47.55]	180 [47.55]	180 [47.55]
11182638	PVH/PVHC	240 [63.40]	240 [63.40]	240 [63.40]	240 [63.40]
11182635	PVH/PVHC	320 [84.54]	320 [84.54]	320 [84.54]	320 [84.54]
11182621*	PVH/PVHC	400 [105.67]	400 [105.67]	400 [105.67]	400 [105.67]

* Up to 500 l/min in combination with PVB 256 3-way Turbo Compensator feature

Asymmetric spools

Part number	Actuation	Flow - l/min (US gal/min)			
		A→T	P→A	P→B	B→T
**	PVH/PVHC	65 [17.17]	65 [17.17]	130 [34.34]	130 [34.34]
	PVH/PVHC	95 [25.10]	95 [25.10]	180 [47.55]	180 [47.55]
	PVH/PVHC	130 [34.34]	130 [34.34]	240 [63.40]	240 [63.40]
	PVH/PVHC	180 [47.55]	180 [47.55]	320 [84.54]	320 [84.54]
	PVH/PVHC	240 [63.40]	240 [63.40]	400 [105.67]	400 [105.67]

** Please contact your Danfoss Power Solutions representative if one of these variants is needed.

Flow control spool throttled open neutral position

Schematic

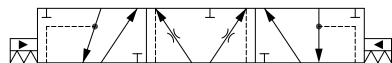

P109178

Technical Information
PVG 128/256 Technical Information
PVBS Main Spool
Symmetric flow control spools

Part number	Actuation	Flow - l/min (US gal/min)			
		A→T	P→A	P→B	B→T
1	PVE	65 [17.17]	65 [17.17]	65 [17.17]	65 [17.17]
11182537	PVE	95 [25.10]	95 [25.10]	95 [25.10]	95 [25.10]
11178290	PVE	130 [34.34]	130 [34.34]	130 [34.34]	130 [34.34]
11178310	PVE	180 [47.55]	180 [47.55]	180 [47.55]	180 [47.55]
11182619	PVE	240 [63.40]	240 [63.40]	240 [63.40]	240 [63.40]
11182618	PVE	320 [84.54]	320 [84.54]	320 [84.54]	320 [84.54]
11182617 ²	PVE	400 [105.67]	400 [105.67]	400 [105.67]	400 [105.67]
(1)	PVH/PVHC	65 [17.17]	65 [17.17]	65 [17.17]	65 [17.17]
11183604	PVH/PVHC	95 [25.10]	95 [25.10]	95 [25.10]	95 [25.10]
11183602	PVH/PVHC	130 [34.34]	130 [34.34]	130 [34.34]	130 [34.34]
11183441	PVH/PVHC	180 [47.55]	180 [47.55]	180 [47.55]	180 [47.55]
11178318	PVH/PVHC	240 [63.40]	240 [63.40]	240 [63.40]	240 [63.40]
11180718	PVH/PVHC	320 [84.54]	320 [84.54]	320 [84.54]	320 [84.54]
11178984 (2)	PVH/PVHC	400 [105.67]	400 [105.67]	400 [105.67]	400 [105.67]

¹ Please contact your Danfoss Power Solutions representative if one of these variants is needed.

² Up to 500 l/min in combination with PVB 256 3-way Turbo Compensator feature

Asymmetric flow control spools

Part number	Actuation	Flow - l/min (US gal/min)			
		A→T	P→A	P→B	B→T
**	-	65 [17.17]	65 [17.17]	130 [34.34]	130 [34.34]
	-	95 [25.10]	95 [25.10]	180 [47.55]	180 [47.55]
	-	130 [34.34]	130 [34.34]	240 [63.40]	240 [63.40]
	-	180 [47.55]	180 [47.55]	320 [84.54]	320 [84.54]
	-	240 [63.40]	240 [63.40]	400 [105.67]	400 [105.67]

** Please contact your Danfoss Power Solutions representative if one of these variants is needed.

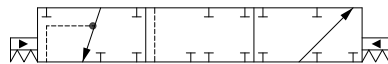
Single acting cylinder flow control spool closed neutral position, flow control B port
Schematic

P109179

Part number	Actuation	Flow - l/min (US gal/min)			
		A→T	P→A	P→B	B→T
1	PVE	-	-	65 [17.17]	65 [17.17]
(1)	PVE	-	-	95 [25.10]	95 [25.10]
(1)	PVE	-	-	130 [34.34]	130 [34.34]
(1)	PVE	-	-	180 [47.55]	180 [47.55]
(1)	PVE	-	-	240 [63.40]	240 [63.40]
(1)	PVE	-	-	320 [84.54]	320 [84.54]
(1) ²	PVE	-	-	400 [105.67]	400 [105.67]

PVBS Main Spool

Part number	Actuation	Flow - l/min (US gal/min)			
		A→T	P→A	P→B	B→T
(1)	PVH/PVHC	-	-	65 [17.17]	65 [17.17]
(1)	PVH/PVHC	-	-	95 [25.10]	95 [25.10]
(1)	PVH/PVHC	-	-	130 [34.34]	130 [34.34]
(1)	PVH/PVHC	-	-	180 [47.55]	180 [47.55]
(1)	PVH/PVHC	-	-	240 [63.40]	240 [63.40]
(1)	PVH/PVHC	-	-	320 [84.54]	320 [84.54]
(1)(2)	PVH/PVHC	-	-	400 [105.67]	400 [105.67]

¹ Please contact your Danfoss Power Solutions representative if one of these variants is needed.

² Up to 500 l/min in combination with PVB 256 3-way Turbo Compensator feature

Flow control spool closed neutral position with A-float

Schematic

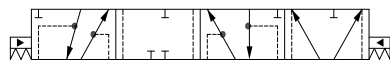

P109180

Symmetric flow control spools

Part number	Actuation	Flow - l/min (US gal/min)			
		A→T	P→A→F	P→B	B→T
¹	PVE	65 [17.17]	65 [17.17]	65 [17.17]	65 [17.17]
(1)	PVE	95 [25.10]	95 [25.10]	95 [25.10]	95 [25.10]
(1)	PVE	130 [34.34]	130 [34.34]	130 [34.34]	130 [34.34]
(1)	PVE	180 [47.55]	180 [47.55]	180 [47.55]	180 [47.55]
(1)	PVE	240 [63.40]	240 [63.40]	240 [63.40]	240 [63.40]
(1)	PVE	320 [84.54]	320 [84.54]	320 [84.54]	320 [84.54]
(1)	PVH/PVHC	65 [17.17]	65 [17.17]	65 [17.17]	65 [17.17]
(1)	PVH/PVHC	95 [25.10]	95 [25.10]	95 [25.10]	95 [25.10]
(1)	PVH/PVHC	130 [34.34]	130 [34.34]	130 [34.34]	130 [34.34]
(1)	PVH/PVHC	180 [47.55]	180 [47.55]	180 [47.55]	180 [47.55]
(1)	PVH/PVHC	240 [63.40]	240 [63.40]	240 [63.40]	240 [63.40]
(1)	PVH/PVHC	320 [84.54]	320 [84.54]	320 [84.54]	320 [84.54]

¹ Please contact your Danfoss Power Solutions representative if one of these variants is needed.

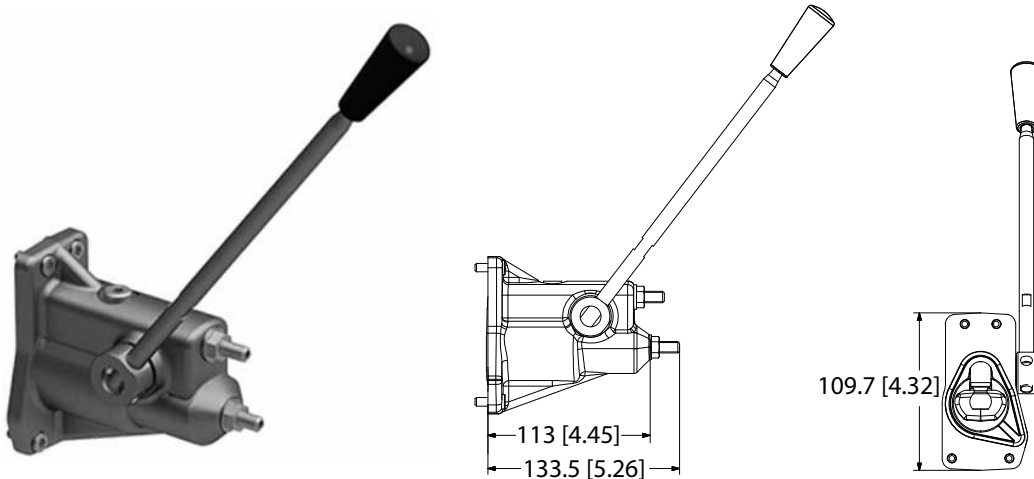
Technical Information
PVG 128/256 Technical Information
PVM Manual Activation
PVM Lever dimensions

Weight: 1.5 kg [3.3 lbs]

The PVM manual activation cover is intended for use on any work section where the operator has to have the ability to interact with the spool manually.

The adjustment screws are intended for limiting the spool travel and thereby the maximum achievable flow.

PVM Technical Data
Technical data

Spool displacement		Torque	
From neutral position	PVM+PVMD	12 N·m	106 lb·in
	PVM+PVE	12 N·m	106 lb·in
	PVM+PVH	30 N·m	265 lb·in
Max. spool travel	PVM+PVMD	30 N·m	265 lb·in
	PVM+PVE	30 N·m	265 lb·in
	PVM+PVH	91 N·m	805 lb·in
Standard Control Range		30°	
Control lever range + float position		37°	

Part numbers for PVM Manual Activation

Part number	Material	Adjustment screws	Lever base and lever	B-port Gauge
11176644	Cast iron	-	Yes	No
11175317	Cast iron	Yes	Yes	G1/8" BSP
11176635	Cast iron	Yes	Yes	3/8"-24 UNF

Technical Information
PVG 128/256 Technical Information
PVH Hydraulic Actuation

PVH dimensions

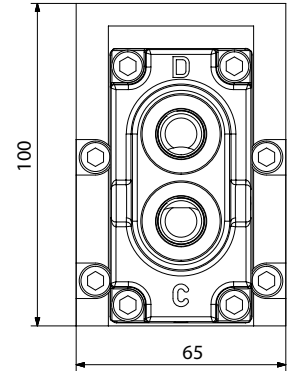
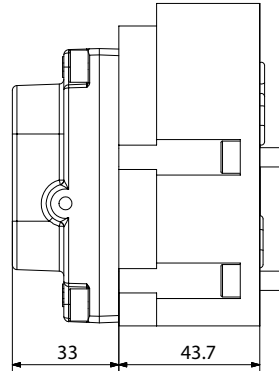
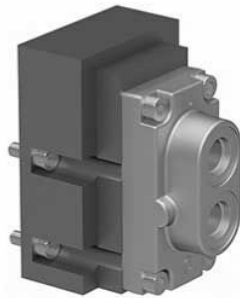

Weight: 1.9 kg [4.2 lbs]

The PVH hydraulic activation cover is intended for use on any work section where the operator wants to have a possibility to interact with the main spool via a hydraulic joystick.

Inlet with Hydraulic Pilot Pressure is needed.

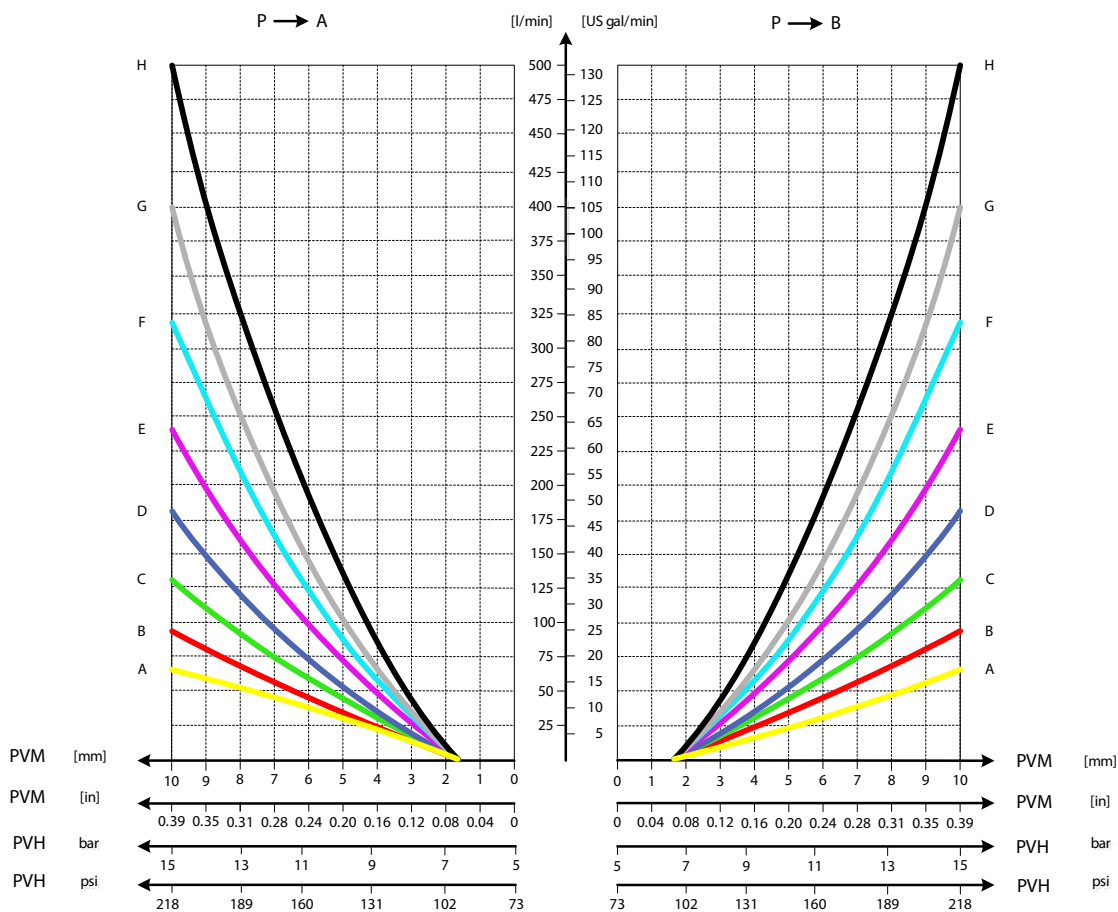

P109247

Technical Information

PVG 128/256 Technical Information

PVH Hydraulic Actuation**PVH Technical Data***Technical data*

Main Spool Spring control pressure range	5 – 15 bar	[73 – 218 psi]
Pilot oil pressure range between 20 and 25 bar	20 – 25 bar	[290 – 362 psi]
Max. pressure on port T (the hydraulic remote control lever should be connected directly to tank).	10 bar	[145 psi]

Part numbers for PVH Hydraulic Actuation

Part number	Material	Connection
11187777	Aluminum	G1/4" BSP
11187776	Aluminum	9/16"-18 UNF

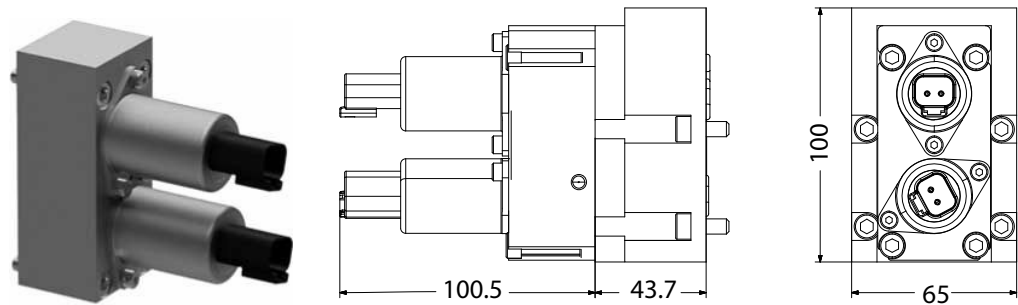
PVHC Electro-Hydraulic Actuator type

Weight: 2.6 kg [5.7 lbs]

The PVHC is an electrical actuator module for main spool control.

The PVHC control is done by dual Pulse Width Modulated (PVM) high current supply 100-400 Hz PWM control signals.

The hysteresis is affected by viscosity, friction, flow forces, dither frequency and modulation frequency. The spool position will shift when conditions are changed such as temperature change.

Inlet with Hydraulic Pilot Pressure is needed.

Dither frequency with a certain amplitude is needed for optimal application performance.

Schematic

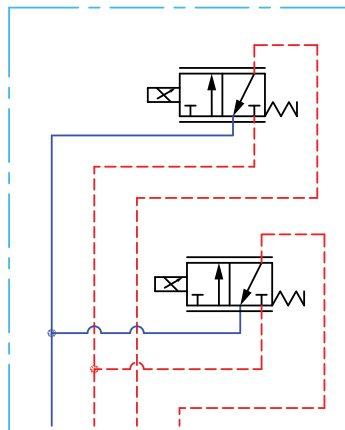

P109249

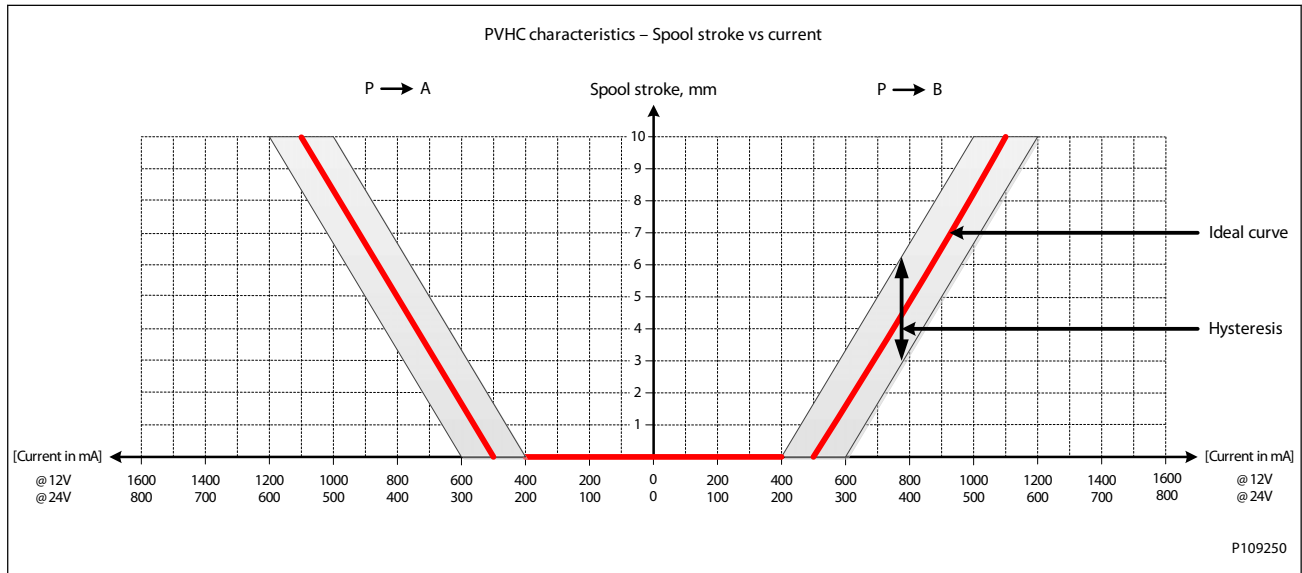
Technical Information
PVG 128/256 Technical Information
PVHC Electro-Hydraulic Actuator type

PVHC Technical Data
Technical data

Main Spool Spring control pressure range	5-15 bar	[73-218 psi]
Pilot oil pressure range between 20 and 25 bar	20-25 bar	[290-362 psi]
Max. pressure on port T	10 bar	[145 psi]
PVHC 12 Volt Current Input	0-1500 mA	
PVHC 24 Volt Current Input	0-750 mA	
Ambient Temperature Range	-30°C to 80°C	[-22 °F to 176°F]
Medium Temperature Range	-20°C to 80°C	[-4 °F to 176°F]
Oil contamination according to ISO 4406 Maximum	23/19/16	

Part numbers for PVHC Electro-Hydraulic Actuator types

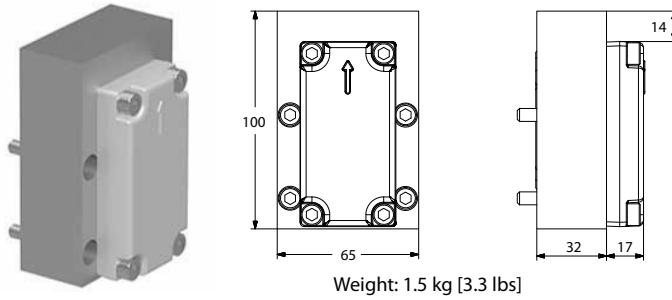
Part number	Power supply	Connector type
11187757	12V	AMP
11187772	12V	DEUTSCH
11187774	24V	AMP
11187775	24V	DEUTSCH

Technical Information
PVG 128/256 Technical Information
PVMD Cover Manual Actuation Only
PVMD dimensions

The PVMD cover is used when work section is purely mechanical activated.

PVMD Part Numbers
Part numbers for PVMD Covers

Part number	Material
11187779	Aluminum

PVE Electrical Actuator
PVE Series 7 Electrical Actuator

The analog PVE Series 7 is an electro-hydraulic actuator used to control a single work section of a PVG proportional valve group. The PVE Series 7 actuator program includes variants with different performance levels and features for PVG 128/256.

The actuator positions the main spool in a PVG work section in order to control either the flow or the pressure of the oil distributed to/from the work function. The control signal to the actuator is an analog voltage signal, enabling the user to operate the work function remotely by means of a joystick, a controller or the similar.

The electro-hydraulic solenoid valve bridge of the actuator is available in different designs utilizing different regulation principles, depending on performance variant. The actuator positions the main spool by distributing pilot oil pressure to either side of it, pressurizing one side by pilot pressure while relieving the opposite side to tank and vice versa, as illustrated below. All proportional actuators feature a closed-loop spool control and continuous fault monitoring.

The analog PVE Series 7 actuator program for PVG 128/256 features two different main hydraulic principle variants (PVEO and PVEH). The different hydraulic principles combined with the different solenoid valve regulation principles determine whether the actuator controls the spool proportionally according to a demand signal or ON/OFF according to a voltage signal. The voltage control characteristic of the PVE Series 7 actuators is shown in the figure below to the left.

PVG 256 with PVEO

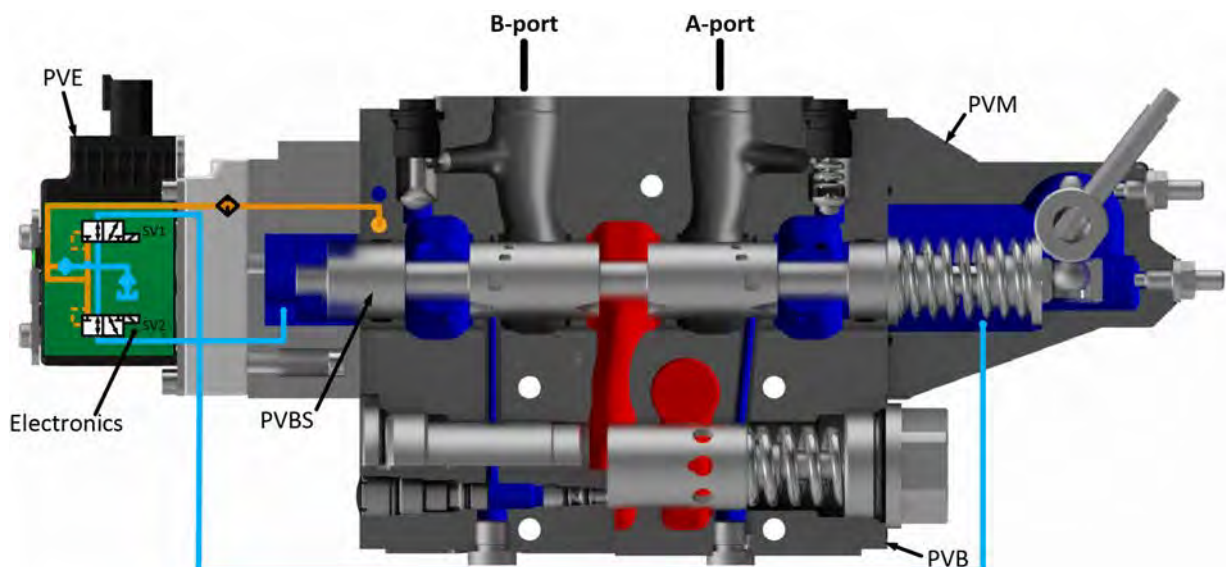

Technical Information

PVG 128/256 Technical Information**PVE Electrical Actuator**

PVG 256 with PVEH

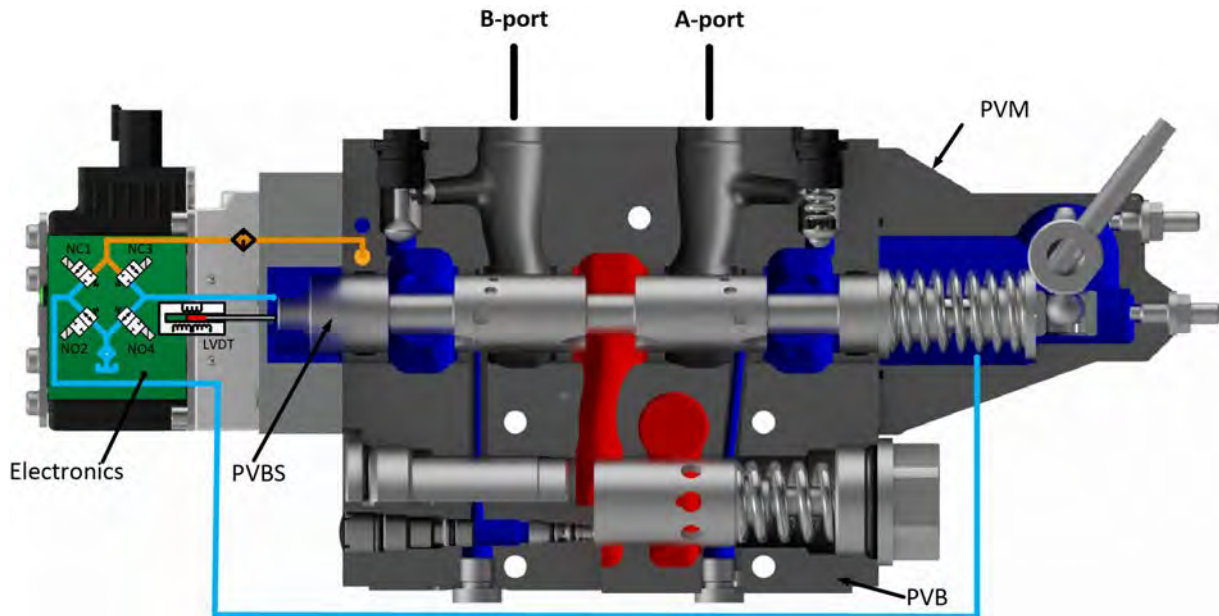

PVE Variant Overview
PVE Variant Overview

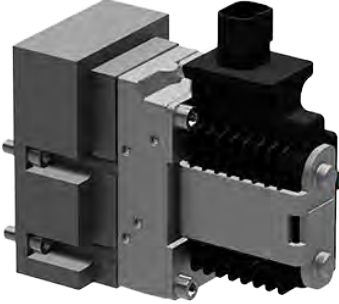
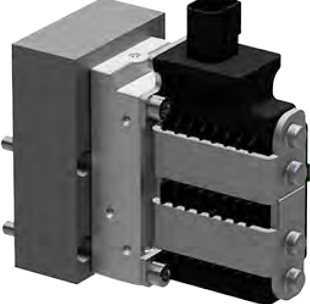
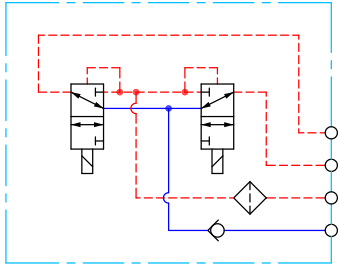
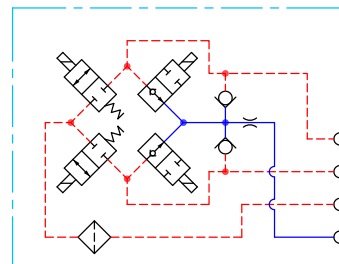
PVEO Series 7	PVEH Series 7
	
Symbol	Description
 <p style="text-align: right;">P109195</p>	<p>PVEO ON/OFF voltage control for non-proportional functions.</p> <ul style="list-style-type: none"> • Neutral position or max. spool stroke according to control signal • Variants available with 12 V dc or 24 Vdc supply voltage • Variants available with DEUTSCH or DIN/Hirschmann connectors • To be used with standard PVE pilot oil pressure of 13.5 bar • LED only indicating Power ON or Power OFF
 <p style="text-align: right;">P109198</p>	<p>PVEH Proportional spool control for functions with high performance and reaction demands.</p> <ul style="list-style-type: none"> • All variants with 11-32 Vdc multi-voltage power supply • Variants available with DEUTSCH or DIN/Hirschmann connectors • To be used with standard PVE pilot oil pressure of 13.5 bar • All variants with LED indicating error state and active or passive fault monitoring • Variants available with Float (-F) or 0-10 V dc control signal (-U) functionality

PVEO

PVE Variant Overview
PVEO

The PVEO actuator is a non-proportional ON/OFF control actuator with open-loop spool control primarily used to control simple ON/OFF work functions where a proportional control of speed or oil flow is not a requirement

PVEO

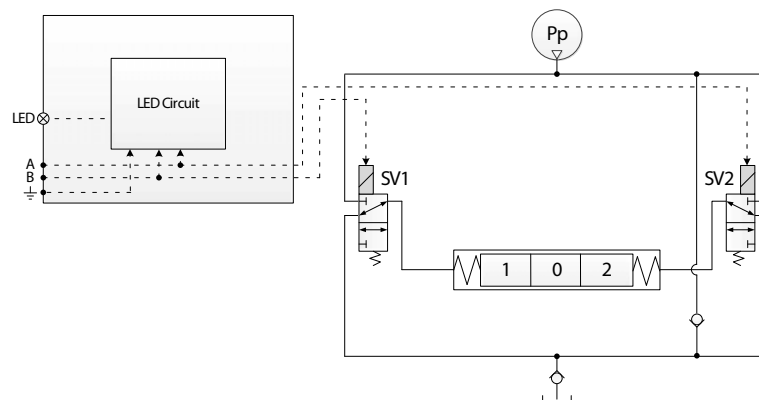
PVEO functionality

The standard PVEO functionality includes the simplest electric circuit of the PVG 128/256 actuator program, using a fixed 12 Vdc or 24 Vdc supply voltage or signal voltage and a simple LED circuit to control the LED light indicating Power ON/OFF.

An energization of solenoid valve SV1 and a simultaneous de-energization of SV2 will cause the main spool to move to the right direction and vice versa. If both SV1 and SV2 are energized or de-energized simultaneously, the main spool stays locked in its neutral position.

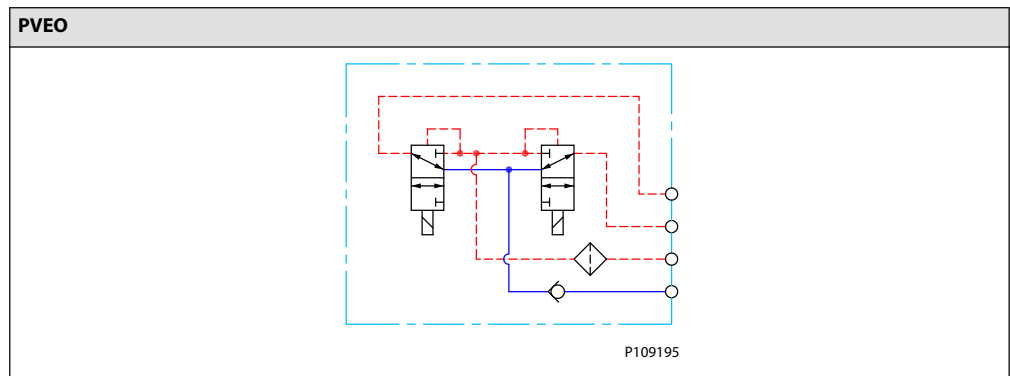
PVE Variant Overview
PVEO Schematics and Dimensions
PVEO schematics

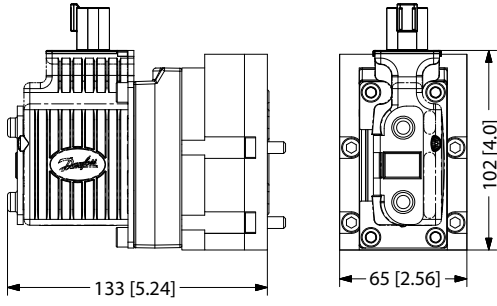
Dimensions

PVEO		Connector height	
 <p>P109127</p>		DEU = 30 mm [1.2 in]	
		DIN = 40 mm [1.6]	
Weight: 2 kg [4.4 lbs]			

PVEO Technical Data
Control Specification

Description	Type	Value	
Supply Voltage (Udc)	Rated	12 Vdc	24 Vdc
	Range	11 to 15 Vdc	22 to 30 Vdc
	Max. ripple	5%	
Current Consumption	Typical	480 mA	250 mA
	Minimum	430 mA	220 mA
	Maximum	950 mA	480 mA

Operating Conditions

Description	Type	Value	
Pilot Pressure	Nominal	13.5 bar	[196 psi]
	Minimum	10.0 bar	[145 psi]
	Maximum	15.0 bar	[218 psi]

PVE Variant Overview
Operating Conditions (continued)

Description	Type	Value	
Oil Consumption	Neutral	0.0 l/min	[0.0 gal/min]
	Locked position	0.0 l/min	[0.0 gal/min]
	Actuating	0.9 l/min	[0.24 gal/min]
Storage Temperature	Ambient	-50 to +90°C	[-58 to +194°F]
Operating Temperature	Ambient	-40 to +90°C	[-40 to +194°F]
Oil Viscosity	Operating range	12 to 75 cSt	[65 to 347 SUS]
	Minimum	4 cSt	[39 SUS]
	Maximum	460 cSt	[2128 SUS]
Oil Cleanliness	Maximum	18/16/13 (according to ISO 4406)	

LED characteristic

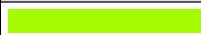
Color	LED characteristic	Description
Green constant		Power ON

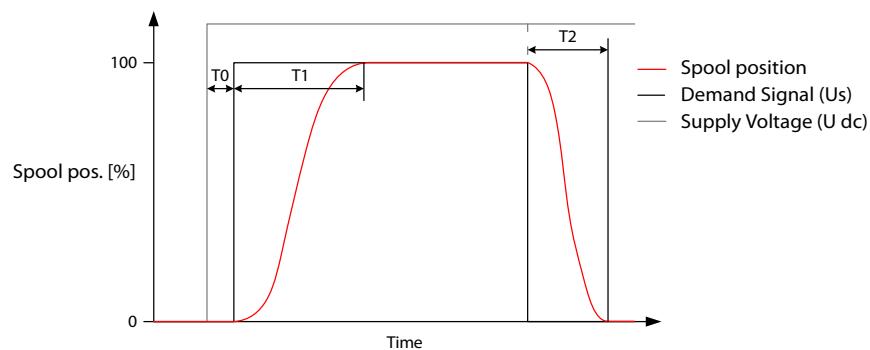
PVEO 128/256 Reaction Times

PVEO

Reaction	PVG128	PVG 256
T1 A-port – Neutral to maximum spool stroke @ Constant Udc	375 ms	375 ms
T1 B-port – Neutral to maximum spool stroke @ Constant Udc	520 ms	520 ms
T2 A-port – Maximum spool stroke to neutral @ Constant Udc	350 ms	350 ms
T2 B-port – Maximum spool stroke to neutral @ Constant Udc	600 ms	600 ms

PVEO Variants for PVG
PVG 128/256 Variants

Part number	Type	Connector	IP	Udc	Functionality
11186328	PVEO	1x4 DEU	67	12 Vdc	Standard
11186330	PVEO	1x4 DEU	67	24 Vdc	Standard
11186331	PVEO	1x4 DIN	65	12 Vdc	Standard
11186342	PVEO	1x4 DIN	65	24 Vdc	Standard

PVE Variant Overview
PVEH
PVEH Overview

The PVEH actuator is a proportional control actuator with closed-loop spool control primarily used to control work functions with high performance requirements.

The PVEH functionality includes an electric circuit with a closed-loop logic. An embedded microcontroller processes the signal voltage and the LVDT feedback signal and regulates the solenoid valves accordingly. Features such as active or passive fault monitoring, LED indicating fault state, error output pin and Power Save are all default PVEH features.

A continuous modulation of solenoid valves NC1 and NO4 together, with a simultaneous energization of NO2 and de-energization of NC3, causes the main spool to move to the right direction and vice versa. When the main spool is stroked to the far right, a simultaneous energization of both NO2 and NO4 and de-energization of both NC1 and NC3 locks the main spool in its stroked position. An emergency stop activated when the spool is stroked will cause all solenoid valves to de-energize causing the main spool to move back to its neutral position by means of the main spool neutral spring and the hydraulic principle.

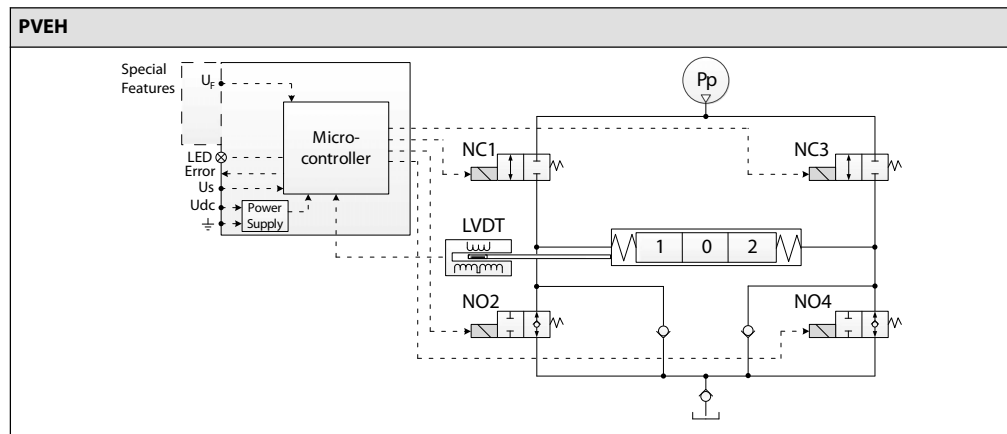
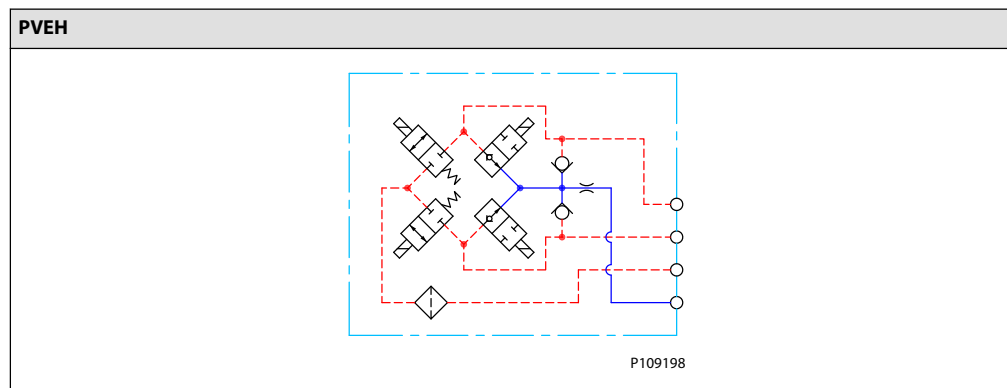
Functionality

PVEH Schematics and Dimensions
Schematics

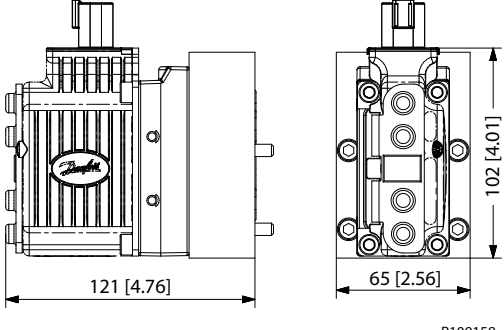
PVE Variant Overview
Dimensions

PVEH	Connector height
 2 kg [4.4]	DEU = 30 mm [1.2 in]
	DIN = 40 mm [1.6 in]

PVEH Technical Data
Control Specification

Description	Type	Value
Supply Voltage (U_{DC})	Rated Range	11 to 32 V _{DC}
	Max. ripple	5%
Signal Voltage PWM (U_S)	Neutral	$U_S = 0.5 U_{DC} = 50\%$ DUT
	Q: P to A	$U_S = (0.5 \text{ to } 0.25) U_{DC} = 50\%$ to 25% DUT
	Q: P to B	$U_S = (0.5 \text{ to } 0.75) U_{DC} = 50\%$ to 75% DUT
Input Impedance	Rated	12 k Ω
Input Capacitance	Rated	100 nF

Current consumption

Description	@ 12 V _{DC}	@ 24 V _{DC}
PWM Frequency (U_S) recommended	> 1000 Hz	> 1000 Hz
Current Consumption	540 mA	270 mA
Power Save	25 mA @ $U_{DC} = 32$ V _{DC}	

Pilot pressure

Minimum	Nominal	Maximum
10.0 bar [145 psi]	13.5 bar [196 psi]	15.0 bar [218 psi]





Fluid consumption

Neutral	Locked position	Actuating
0.0 l/min	0.0 l/min	0.7 l/min [0.18 US gal/min]

PVE Variant Overview
Technical specification

Parameter	Minimum	Recommended range	Maximum
Fluid viscosity	4 mm ² /s [39 SUS]	12 to 75 mm ² /s [65 to 347 SUS]	460 mm ² /s [2128 SUS]
Fluid cleanliness	18/16/13 (according to ISO 4406)		
Storage temperature	Ambient: -50 to 90°C [-58 to 194°F]		
Operating temperature	Ambient: -30 to 60°C [-22 to 140°F]		

LED Characteristic

Color	LED Characteristic	Description
Green constant		No error – Actuating
Green flashing @ 1.5 Hz		Neutral – Power save
Red constant		Internal error
Red flashing @ 1.5 Hz		External or Float error
Yellow		Disable mode

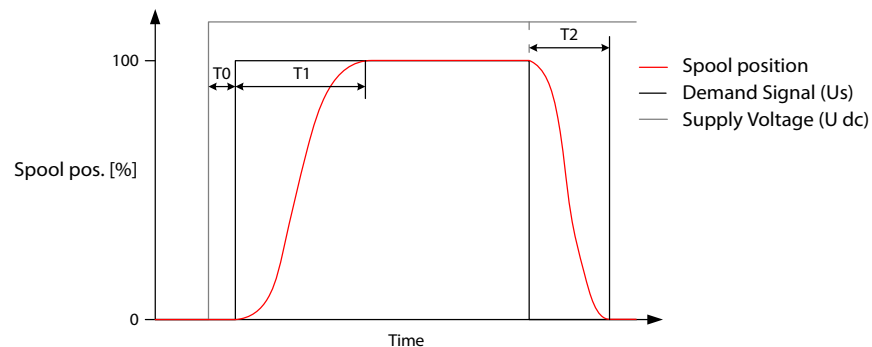
PVEH for PVG 128/256 Reaction Times

P109128

PVEH

Reaction	PVG 128	PVG 256
T0 – Boot up	80 ms	80 ms
T1 – Neutral to maximum spool stroke @ Power ON	400 ms	380 ms
T2 – Maximum spool stroke to neutral @ Power OFF	300 ms	270 ms
T1 – Neutral to maximum spool stroke @ Constant Udc	320 ms	320 ms
T2 – Maximum spool stroke to neutral @ Constant Udc	250 ms	250 ms
T0 + Deadband	130 ms	130 ms

 For more information on reaction times, see [Reaction Times](#).

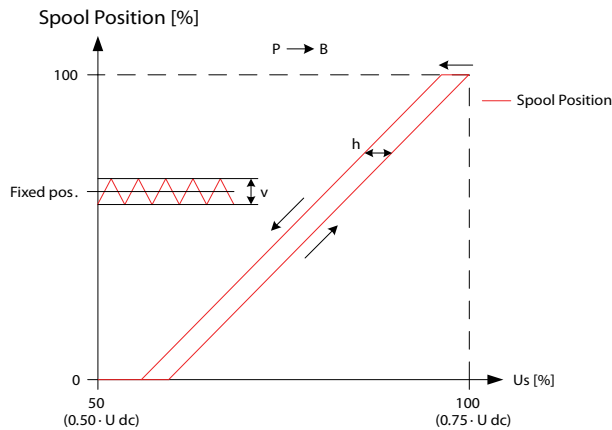
PVE Variant Overview
PVEH Hysteresis and Ripple

Description	Type	PVEH
Hysteresis (h)	Rated [%]	<2
Steady state ripple @ fixed Us (v)	Rated [mm]	0.0

For more information on hysteresis and ripple, see [Hysteresis and Ripple](#).

PVEH Variants for PVG
PVG 128/256 variants

Part number	Type	Connector	IP	Fault monitoring	Functionality
11186325	PVEH	1x4 DEU	67	Passive	Standard
11186326	PVEH	1x4 DEU	67	Active	Standard
11186321	PVEH	1x4 DIN	65	Passive	Standard
11186322	PVEH	1x4 DIN	65	Active	Standard

Connector Overview
Connector Overview
PVEO 4-pin Connector

Pinout	Pin 1	Pin 2	Pin 3	Pin 4
1x4 DEUTSCH	U _{DC-A}	GND	GND	U _{DC-B}
1x4 DIN	U _{DC-A}	U _{DC-B}	-	GND

PVEH/PVEH-U

Pinout	Pin 1	Pin 2	Pin 3	Pin 4
1x4 DEUTSCH	U _S	Error	GND	U _{DC}
1x4 DIN	U _{DC}	U _S	Error	GND

PVEH-FLA 6-pin Connector

Pinout	Pin 1	Pin 2	Pin 3	Pin 4	Pin 5	Pin 6
1x6 DEUTSCH	U _S	Error	Float	-	GND	U _{DC}

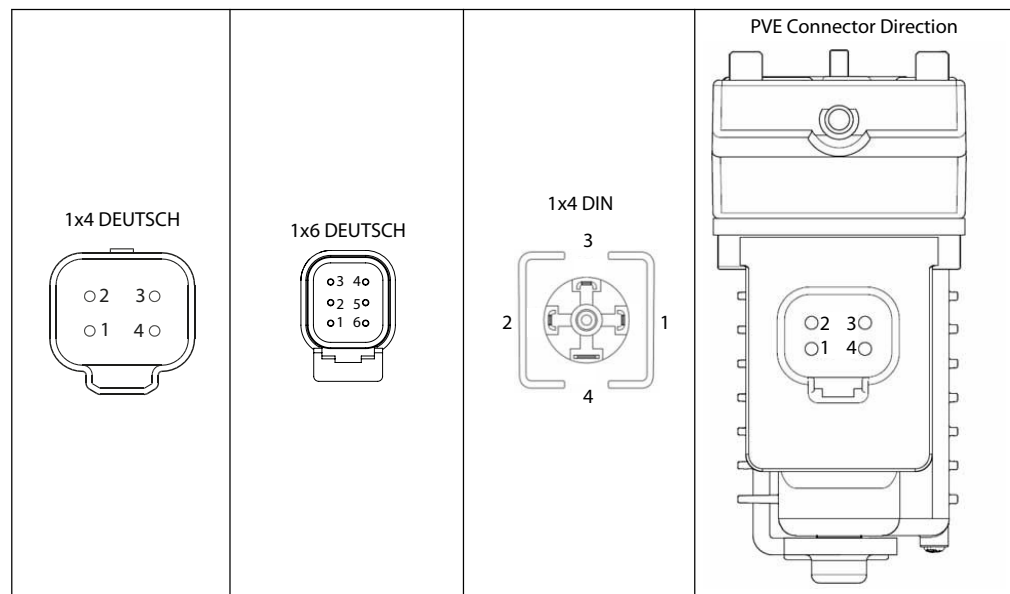
Connector diagrams

Fault Monitoring and Reaction

All proportional control PVG 128/256 actuators feature:

- Integrated fault monitoring
- Detecting spool stroke inconsistencies
- Detecting internal hardware defects
- Detecting demand signal inconsistencies
- Fault reaction depending on the type of fault monitoring
 - Generic
 - Specific

Passive and active fault monitoring refers to whether or not the actuator is reacting on the error when it is detected.

Active fault monitoring

No matter what kind of error is detected, the solenoid valves will be disabled and the operation that the valves/spool controls will stop immediately. Active fault monitoring keeps a “memory” of the error, even if it is no longer registered. The active fault monitoring does not have Auto Recovery because of this “memory” and a reboot/restart will therefore be required to reactivate the solenoid valves.

With an active fault monitoring the following scenarios will take place when an error is detected/occurs:

- The LED light will switch from green to red and the error pin output will go high
- The solenoid valves will be disabled and the operation that the valves/spool controls will stop immediately
- The active fault monitoring does not have Auto Recovery, so when the error is fixed/no longer is registered a reboot/restart of the PVE is required to reactivate it.

Passive fault monitoring

Passive fault monitoring does not disable the solenoid valves when an error is detected. It will continue to operate despite that an error was detected. When the error no longer is registered the passive fault monitoring will “forget” the error and continue as if the error was never there.

With a passive fault monitoring the following conditions will happen when an error is detected/occurs:

- The LED light will switch from green to red and the error pin output will go high
- The solenoid valves will continue operating at the set point given at the time of the error
 - Only exception is if the error is caused by the supply voltage (U_{DC}) being either above or below the allowed range or if the temperature measured on the internal electronics board is higher than allowed. In these cases, the solenoid valves will be disabled.

Generic Fault Reaction















All PVE actuators with fault monitoring are triggered by the following main events:

Control Signal Monitoring	The Control signal voltage (U_S) is continuously monitored. The permissible range is between 15% and 85% of the supply voltage (U_{DC}). Outside this range the PVE will switch into an error state. A disconnected U_S pin (floating) is recognized as a neutral set point.
Transducer/LVDT Supervision	The internal LVDT wires are monitored. If the signals are interrupted or short-circuited, the PVE will switch into an error state.
Supervision of Spool Position	The actual position must always correspond to the demanded position (U_S). If the actual spool position is further out from neutral than the demanded spool position or in opposite direction, the PVE will switch into an error state. Spool position closer to neutral and in same direction will not cause an error state – the situation is considered <i>in control</i> .

Fault Monitoring and Reaction

Float Position Monitoring	Float position must be entered or left within a time limit. A too high delay on the 1x6 pin float PVE will cause an error state – this is relevant for the 1x6 pin PVEH-F actuators only.
Temperature Monitoring	When the temperature is too high the PVE LED will light constant red and solenoid valves will be disabled.

PVEH Fault Reaction Overview

Description	Monitoring	LED	Solenoid valves	Error pin output	Fault reaction time (ms)
					PVEH
Spool not at setpoint	Active*		Disabled	High	500
	Passive		-	High	250
Unable to reach float position	Active*		Disabled	High	1000
	Passive		-	High	1000
U dc > max.	Active		Disabled	-	-
	Passive		Disabled	-	-
U dc < min.	Active		Disabled	-	-
	Passive		Disabled	-	-
Us out of range	Active*		Disabled	High	500
	Passive		-	High	250
LVDT error	Active*		Disabled	High	500
	Passive		-	High	250
Temp > max.	Active*		Disabled	High	250
	Passive		Disabled	High	250

* Does not have Auto Recovery

Functionality Overview

Standard and Fixed US 0-10 Vdc

All standard proportional actuator variants PVEH can be controlled by an analog signal voltage (U_s) or a PWM controlled signal voltage (U_s) proportional to the supply voltage (U_{dc}).

PVEO

Description	Type	Value	
Supply voltage (U_{dc})	Rated	12 Vdc	24 Vdc
	Range	11 to 15 Vdc	22 to 30 Vdc
	Max. ripple	5%	

PVEH

Description	Type	Value
Supply voltage (U_{dc})	Rated	11 to 32 Vdc
	Range	11 to 32 Vdc
	Max. ripple	5%
Signal voltage (U_s)	Neutral	$U_s = 0.5 \cdot U_{dc}$
	Q: P to A	$U_s = (0.5 \text{ to } 0.25) \cdot U_{dc}$
	Q: P to B	$U_s = (0.5 \text{ to } 0.75) \cdot U_{dc}$

The PVEH-U variants are controlled by a fixed 0-10 Vdc signal voltage (U_s), directly compatible with standard PLC control.

PVEH-U

Description	Type	Value
Supply voltage (U_{dc})	Rated	11 to 32 Vdc
	Range	11 to 32 Vdc
	Max. ripple	5%
Signal voltage (U_s)	Neutral	$U_s = 5 \text{ V}$
	Q: P to A	5 V to 2.5 V
	Q: P to B	5 V to 7.5 V

PWM Voltage Control

The PVEH actuator variants can be controlled by a PWM controlled signal voltage (U_s) proportional to the supply voltage (U_{dc}).

The V_1 and V_2 must be symmetrical around $U_{dc}/2$ and V_1 must be equal to or less than U_{dc} .

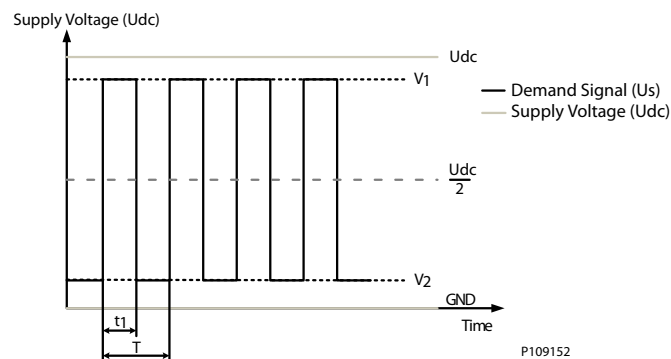

Technical Information

PVG 128/256 Technical Information

Functionality Overview
PVEH Control specification

Description	Type	Value
Supply Voltage (Udc)	Rated	11 to 32 Vdc
	Range	11 to 32 Vdc
	Max. ripple	5%
Signal Voltage PWM (Us)	Neutral	Us = 50% DUT
	Q: P to A	Us = 50% to 25% DUT
	Q: P to B	Us = 50% to 75% DUT
PWM Frequency (Us)	Recommended	> 1000 Hz

Functionality Overview
Float A-Port (-FLA)

The Float A-Port functionality enables the proportional PVEH-FLA actuator variants to enter the main spool into a float position. The PVE actuators with Float A-Port functionality is compatible with the dedicated main spools with electronic float in A-port.

PVE Type	PVBS Type	Standard Flow Control	Float Control
PVEH-FLA (1x6 pin)	Deadband 1.7 mm	$U_s = (0.25 \rightarrow 0.75) \cdot U_{dc}$	U _{dc} to dedicated float pin (UF)
	Max. B-port flow 8.0 mm		

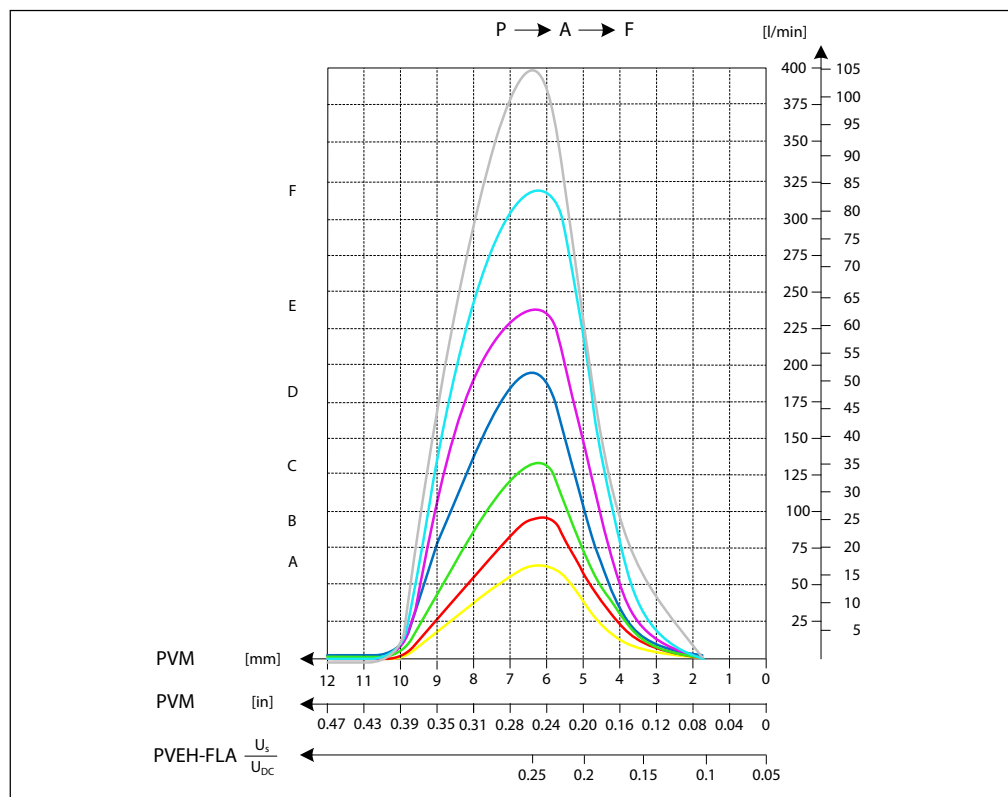
PVE Power Save

All proportional actuator variants feature a Power Save mode, de-energizing the solenoid valve bridge. The Power Save mode is entered when the signal voltage (U_s) and the LVDT spool position has been in neutral for 750 ms. As soon as the signal voltage (U_s) or the LVDT spool position is out of neutral the PVE will leave its Power Save mode and re-energize the solenoid valve bridge as usual.

The Power Save mode results in increased power efficiency by reducing the current consumption of the PVE actuators in neutral position. The Power Save mode has no effect on the performance of the PVE actuator.

Special Features

Dedicated Float Pin (UF)

The Dedicated Float Pin (UF) feature is related to the PVEH-FLA actuator variant enabling the user to move the main spool into its float position by power. The PVEH-FLA uses 1x6 pin AMP or DEUTSCH connectors.

- Normal operation: Low or not connected
- High Float
- Input range: U_{DC}
- Max. voltage: $32 V_{DC}$

PVEH-FLA functionality diagram

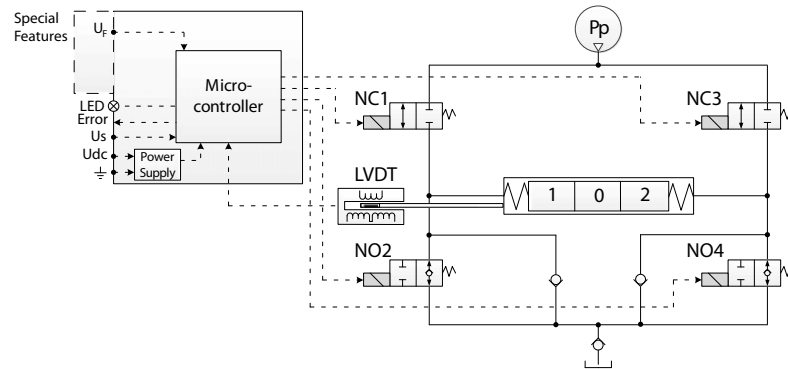

Disable Mode

The PVEH-U actuator variants controlled by a fixed 0-10 V_{DC} signal voltage (U_S), feature the ability to enter a disable mode. This causes the counteracting force on the main spool created by the solenoid valve bridge to deactivate, when using Manual OverRide (MOR).

The disable mode is entered by sending a signal voltage (U_S) of 16.2% of 10 V_{DC} when in Power Save.

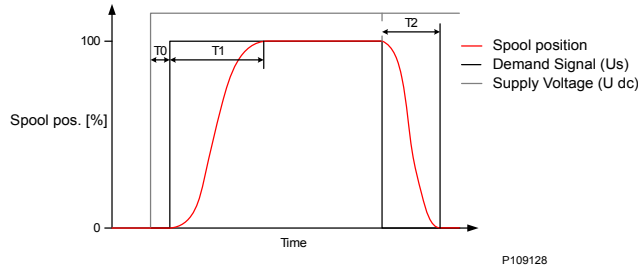
Technical Information
PVG 128/256 Technical Information
Performance Overview
PVG 128/256 Reaction Times

Reaction
T0 – Boot-up [ms]
T1 – Neutral to max. spool stroke
T2 – Max. spool stroke to neutral
T1 – Neutral to max. spool stroke
T2 – Max. spool stroke to neutral

PVEO

Reaction	PVG128	PVG 256
T1 A-port – Neutral to maximum spool stroke @ Constant Udc	375 ms	375 ms
T1 B-port – Neutral to maximum spool stroke @ Constant Udc	520 ms	520 ms
T2 A-port – Maximum spool stroke to neutral @ Constant Udc	350 ms	350 ms
T2 B-port – Maximum spool stroke to neutral @ Constant Udc	600 ms	600 ms

PVEH

Reaction	PVG 128	PVG 256
T0 – Boot up	80 ms	80 ms
T1 – Neutral to maximum spool stroke @ Power ON	400 ms	380 ms
T2 – Maximum spool stroke to neutral @ Power OFF	300 ms	270 ms
T1 – Neutral to maximum spool stroke @ Constant Udc	320 ms	320 ms
T2 – Maximum spool stroke to neutral @ Constant Udc	250 ms	250 ms
T0 + Deadband	130 ms	130 ms

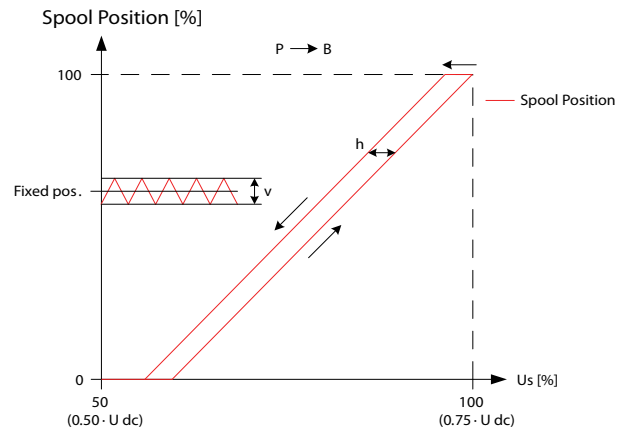
Performance Overview
Hysteresis and Ripple

Type	Hysteresis (h)	Steady state ripple @ fixed Us (v)
	Rated [%]	Rated [mm]
PVEH 256	1.5	0.0

The stated values are preliminary values and can be subject to change once an increased statistical basis is achieved.

Oil Consumption

Type	Neutral	Locked position	Actuating
	[l/min]		
PVEO	0.0	0.0	0.9
PVEH	0.0	0.0	0.7

PVSI/PVGI End and Interface Plates

The PVG PVGI Interface Plate act as an interface between the PVB 256/128 and PVB 32/16 basic modules which enables you to build a combo valve with PVB 256/128/32/16.

Optional the PVSI End Plate features additional P and T connection to accommodate an additional 600 l/min pump flow.

The PVS end plate variants are based on a generic platform with a selection of additional features, enabling you to tailor the PVSI/PVGI to suit the demands of any hydraulic system. Versions available with LX connection, and P and T connections. PVSI and PVGI are all in cast iron.

The generic PVSI/PVGI End and Interface Plates platform includes the following main variants:

- PVSI with or without LX-connection
- PVSI with P and T connections
- PVSI Interface plate

PVSI with or without LX connection



PVSI with P and T connections

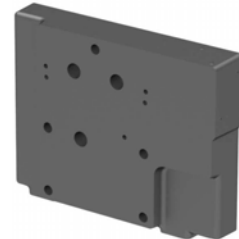

PVGI Interface plate

Technical data

Max. rated pressure	P-port continuous	350 bar	[5076 psi]
	P-port intermittent	400 bar	[5800 psi]
	T-port static/dynamic	25/40 bar	[363/580 psi]
Oil temperature	Recommended	30 to 60°C	[86 to 140°F]
	Minimum	-30°C	[-22°F]
	Maximum	90°	[194°F]
Ambient temperature	Recommended	-30 to 60°C	[-22 to 140°F]
Oil viscosity	Operating range	12 to 75 mm ² /s	[65 → 347 SUS]
	Minimum	4 mm ² /s	[39 SUS]
	Maximum	460 mm ² /s	23/19/16
Oil contamination according to ISO 4406	Maximum	23/19/16	

For more information about PVSI/PVGI End and Interface Plates, see:

[PVSI with or without LX-connection](#) on page 81

[PVSI with P and T port connections](#) on page 82

[PVGI Interface Plate](#) on page 83

PVSI/PVGI End and Interface Plates
PVSI with or without LX-connection

The PVSI made of Cast Iron work as an End Plate.

The PVSI with LX connection enables another valves LS pressure to be shuttled to the pump when needed.

The LX port treads are with BSP or UNF tread.

PVSI with or without LX connection

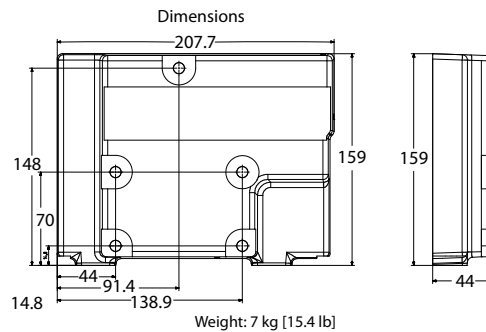
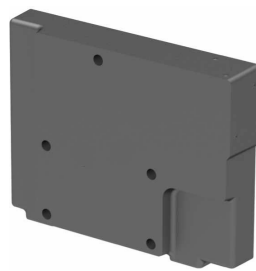
Schematic

P109227

Technical data

Max. rated pressure	P-port continuous	350 bar	[5076 psi]
	P-port intermittent	400 bar	[5800 psi]
	T-port static/dynamic	25/40 bar	[363/580 psi]
Oil temperature	Recommended	30 to 60°C	[86 to 140°F]
	Minimum	-30°C	[-22°F]
	Maximum	90°	[194°F]
Ambient temperature	Recommended	-30 to 60°C	[-22 to 140°F]
Oil viscosity	Operating range	12 to 75 mm ² /s	[65 → 347 SUS]
	Minimum	4 mm ² /s	[39 SUS]
	Maximum	460 mm ² /s	23/19/16
Oil contamination according to ISO 4406	Maximum	23/19/16	

Part numbers for PVSI End Plate with or without LX connection

Part number	LX-port	Mounting feet
11171419	-	M12
11179950	G1/4"BSP	M12
11179949	7/16-20 UNF	M12

PVSI/PVGI End and Interface Plates
PVSI with P and T port connections

The PVSI with P and T port connections enables an additional 600 l/min pump flow to a PVG 128/256 valve.

Metric and SAE flange connections as well as BSP and UNF threaded ports.

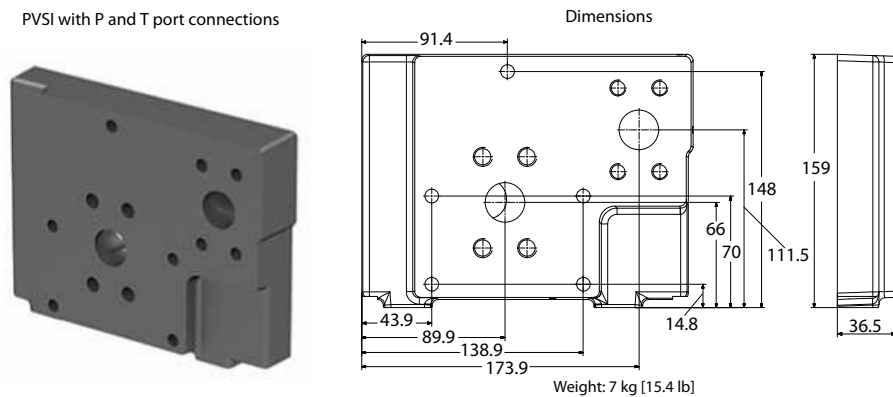
Schematic

Technical data

Max. rated pressure	P-port continuous	350 bar	[5076 psi]
	P-port intermittent	400 bar	[5800 psi]
	T-port static/dynamic	25/40 bar	[363/580 psi]
Oil temperature	Recommended	30 to 60°C	[86 to 140°F]
	Minimum	-30°C	[-22°F]
	Maximum	90°	[194°F]
Ambient temperature	Recommended	-30 to 60°C	[-22 to 140°F]
Oil viscosity	Operating range	12 to 75 mm ² /s	[65 → 347 SUS]
	Minimum	4 mm ² /s	[39 SUS]
	Maximum	460 mm ² /s	23/19/16
Oil contamination according to ISO 4406	Maximum	23/19/16	

Part number	P-port	T-port	Width	Mounting feet
11171418	Metric Flange 1"	Metric Flange 1-1/4"	37 mm	M12
11179952	Thread Ports G1" BSP	Thread Ports G1-1/4" BSP	44 mm	M12
11171421	SAE Flange 1" UNF	SAE Flange 1-1/4" UNF	37 mm	M12
11171416	Thread Ports 1-5/16 UNF	Thread Ports 1-5/8 UNF	44 mm	M12

PVSI/PVGI End and Interface Plates
PVGI Interface Plate

The PVGI Interface Plate connects the P-, T-, LS- and Pp-channels in PVB 128/256 to the corresponding channels in PVB 32 and/or 16 modules. T0 variant featured for PVB 32 modules equipped with T0.

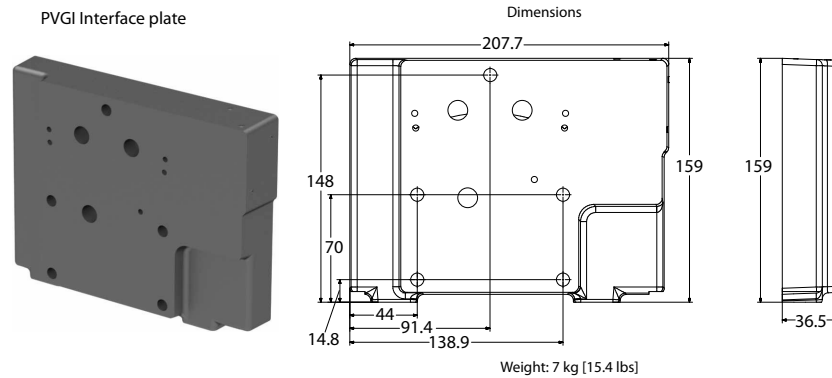
Schematic

Technical data

Max. rated pressure	P-port continuous	350 bar	[5076 psi]
	P-port intermittent	400 bar	[5800 psi]
	T-port static/dynamic	25/40 bar	[363/580 psi]
Oil temperature	Recommended	30 to 60°C	[86 to 140°F]
	Minimum	-30°C	[-22°F]
	Maximum	90°	[194°F]
Ambient temperature	Recommended	-30 to 60°C	[-22 to 140°F]
Oil viscosity	Operating range	12 to 75 mm ² /s	[65 → 347 SUS]
	Minimum	4 mm ² /s	[39 SUS]
	Maximum	460 mm ² /s	23/19/16
Oil contamination according to ISO 4406	Maximum	23/19/16	

Part number	T0	PVGI width	Mounting feet
11171422	No	37 mm	M12
11171423	Yes	37 mm	M12

PVAS

Stay Bolts for PVG 128 and 256 consists of 2 different kits:

1. PVAS containing 2 stay bolts – shall be placed in spec sheet under PVAS 1.
2. PVAS containing 3 stay bolts – shall be placed in spec sheet under PVAS 2.

Furthermore, O-rings is a part of the PVAS kits.

The table below shows which 2 PVAS kits required for the specification according to number of PVB 128 and/or PVB 256.

Table 1

		PVB 256							
		0	1	2	3	4	5	6	7
PVB 128	0		11187672+ 11188215	11187673+ 157B8003	11187656+ 11188208	11187675+ 157B8026	11187696+ 157B8028	11187697+ 11188197	11187689+ 157B8062
	1	11187320+ 11188216	11187677+ 157B8022	11187681+ 157B8024	11187658+ 11188205	11187685+ 157B8008	11187687+ 11188198	11187690+ 157B8081	
	2	11187617+ 11188213	11187678+ 157B8004	11187682+ 11188206	11187686+ 157B8027	11187691+ 11188199	11187704+ 11188195		
	3	11187655+ 157B8023	11187679+ 11188207	11187683+ 11188203	11187705+ 157B8009	11187694+ 11188196	11187695+ 157B8082		
	4	11187684+ 157B8005	11187680+ 11188204	11187696+ 157B8028	11187697+ 11188197	11187689+ 157B8062			
	5	11187658+ 11188205	11187699+ 157B8008	11187688+ 157B8010	11187710+ 11188194				
	6	11187693+ 11188202	11187703+ 157B8029	11187704+ 11188195					
	7	11187705+ 157B8009	11187694+ 11188196						
	8	11187692+ 157B8030	11187709+ 11188189						
	9	11187710+ 11188194							

Ex. For 2 PVB 256 and 1 PVB 128:

PVAS 1 = 11187681

PVAS 2 = 157B8024

For PVG 128/256 in combination with PVG 16/32 please see [PVAS for Combo](#).

PVAS
PVAS for Combo

Stay Bolts for PVG 128/256/16/32 consists of 2 different kits:

1. PVAS containing 2 stay bolts - please look in *Table 2* and use P/N before + symbol.
2. PVAS containing 3 stay bolts – please look in *Table 2* and write down the length in millimeters after the + symbol.

Furthermore, O-rings is a part of the PVAS kits – no additional P/N needed.

Table 2.

		PVB 256								
		0	1	2	3	4	5	6	7	
PVB 128	0	11187676+ 40	11187672+ 126	11187673+ 212	11187656+ 298	11187675+ 384	11187696+ 470	11187697+ 556	11187698+ 642	
	1	11187320+ 106	11187677+ 192	11187681+ 278	11187658+ 364	11187685+ 450	11187687+ 536	11187690+ 622		
	2	11187617+ 172	11187678+ 258	11187682+ 344	11187686+ 430	11187691+ 516	11187704+ 602			
	3	11187655+ 238	11187679+ 324	11187683+ 410	11187705+ 496	11187694+ 582	11187695+ 668			
	4	11187684+ 304	11187680+ 390	11187696+ 476	11187697+ 562	11187689+ 648				
	5	11187658+ 370	11187699+ 456	11187688+ 542	11187710+ 628					
	6	11187693+ 436	11187703+ 522	11187704+ 608						
	7	11187705+ 502	11187694+ 588							
	8	11187692+ 568	11187709+ 654							
	9	11187710+ 634								

Table 3.

		PVB 16										
		0	1	2	3	4	5	6	7	8	9	10
PVB 32	0		64	104	144	184	224	264	304	344	384	424
	1	72	112	152	192	232	272	312	352	392	432	
	2	120	160	200	240	280	320	360	400	440		
	3	168	208	248	288	328	368	408	448			
	4	216	256	296	336	376	416	456				
	5	264	304	344	384	424	464					
	6	312	352	392	432	472						
	7	360	400	440	480							
	8	408	448	488								
	9	456	496									
	10	504										

Example

For 2 PVB 256 and 1 PVB 128 and 1 PVB 32 and 2 PVB 16:

 PVAS 1 P/N = **11187681** from *Table 2*.

PVAS

PVAS 2 = **278** mm from *Table 2* + **152** mm from *Table 3* = 278+152 =430 mm which equals **157B8027** in *Table 4*.

PVAS Part Number Overview
Table 4.

Part number	Accumulated module length in mm
157B8082	661-672
11188189	649-660
157B8062	637-648
11188194	625-636
157B8081	613-624
11188195	601-612
157B8061	589-600
11188196	577-588
157B8030	565-576
11188197	553-564
157B8010	541-552
11188198	529-540
157B8029	517-528
11188199	505-516
157B8009	493-504
11188200	481-492
157B8028	469-480
11188201	457-468
157B8008	445-456
11188202	433-444
157B8027	421-432
11188203	409-420
157B8007	397-408
11188204	385-396
157B8026	373-384
11188205	361-372
157B8006	349-360
11188206	337-348
157B8025	325-336
11188207	313-324
157B8005	301-312
11188208	289-300
157B8024	277-288
11188209	265-276
157B8004	253-264
11188210	241-252
157B8023	229-240
11188211	217-228
157B8003	205-216
11188212	193-204

PVAS

Table 4. (continued)

Part number	Accumulated module length in mm
157B8022	181-192
11188213	169-180
157B8002	157-168
11188214	145-156
157B8021	133-144
11188215	121-132
157B8001	109-120
11188216	97-108
157B8031	85-96
11188217	73-84
157B8000	61-72
11188218	49-60
11188219	20-48

PVG Valve Schematics

Valve Schematics

PVG 128/256 Schematic with Basic End Plate

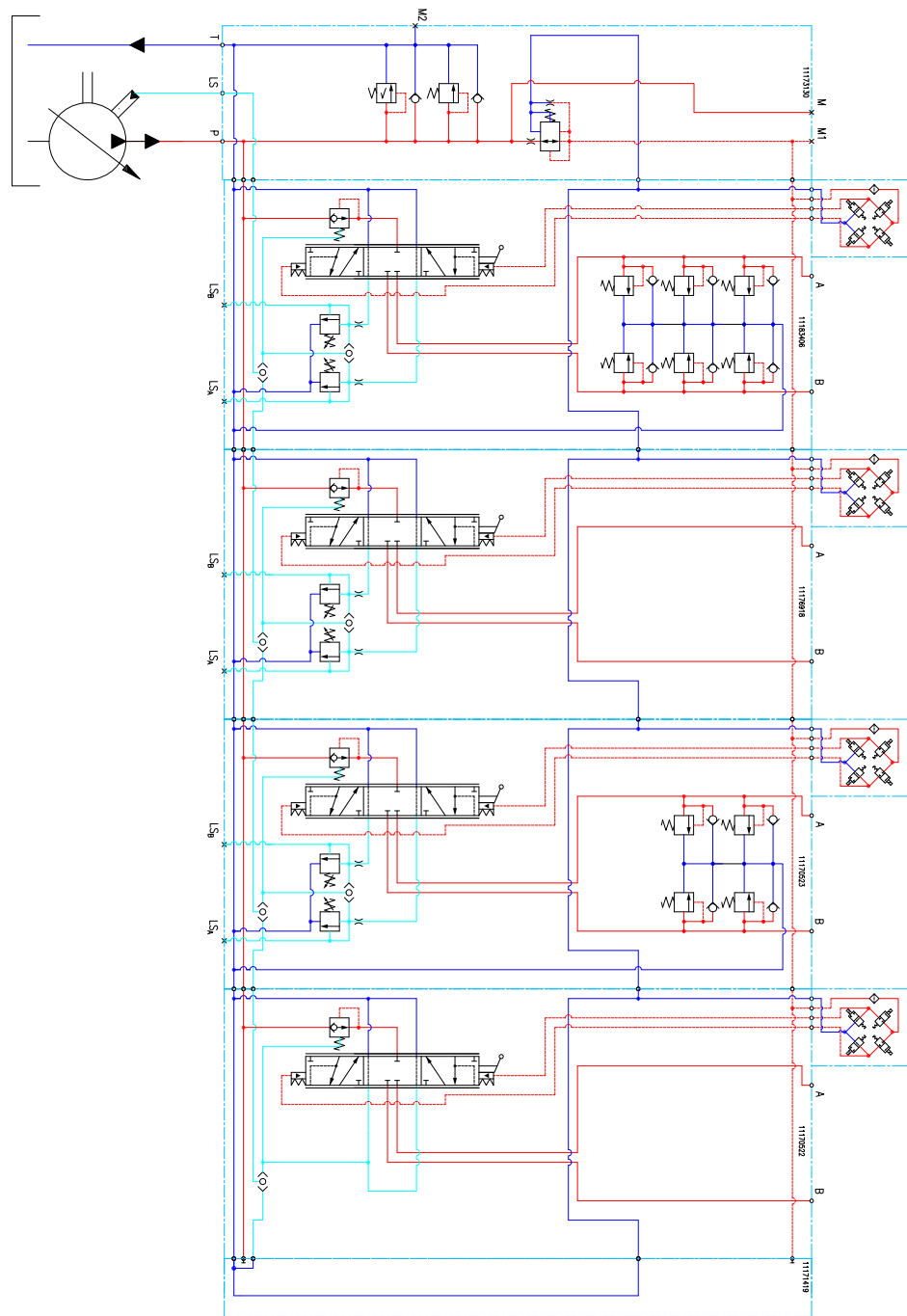

P109254

Technical Information
PVG 128/256 Technical Information

PVG Valve Schematics

PVG 128/256 with P- and T-connection end plate

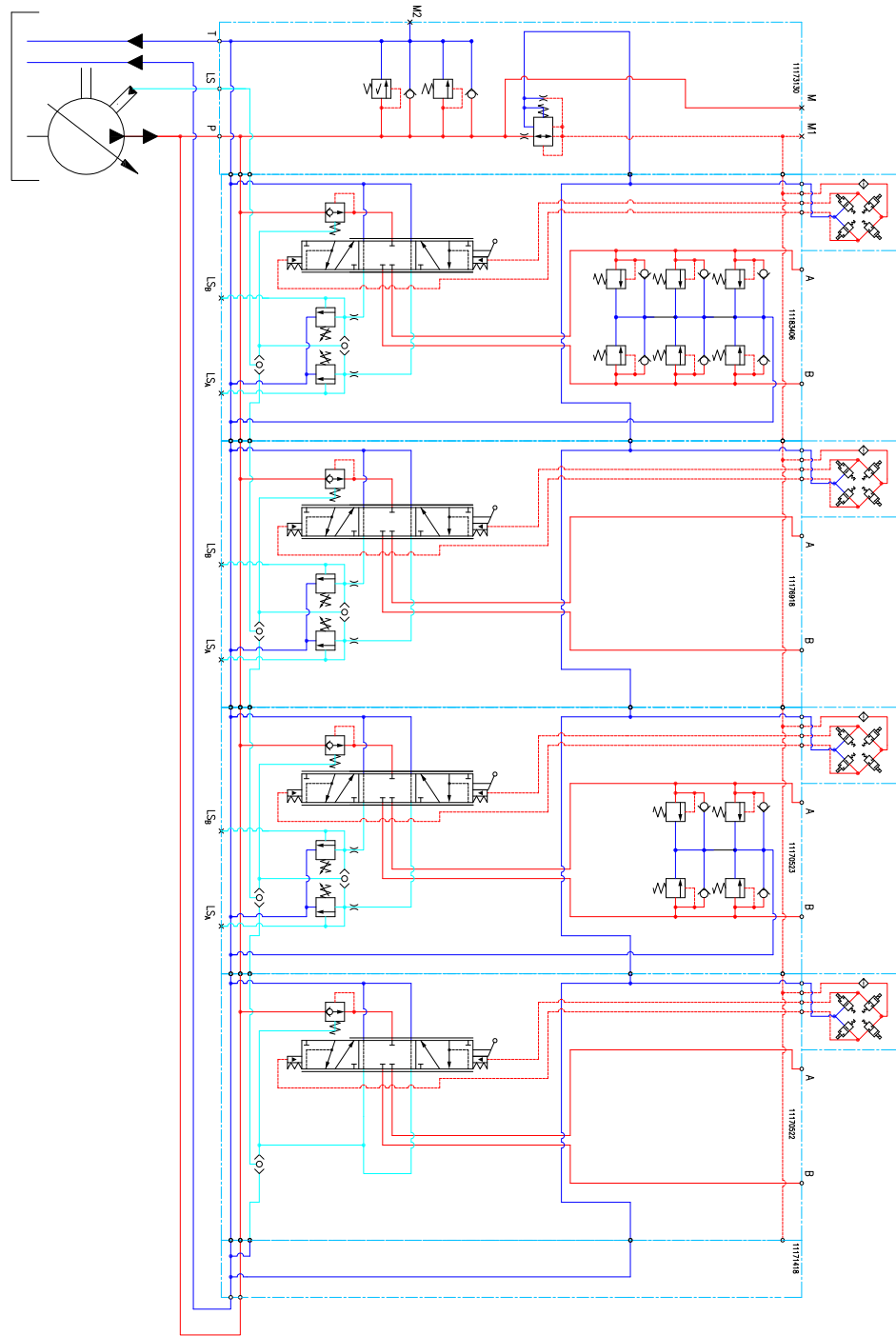

P109255

Technical Information
PVG 128/256 Technical Information

Dimension Overview

Dimension Overview for PVG 128/256

PVEO

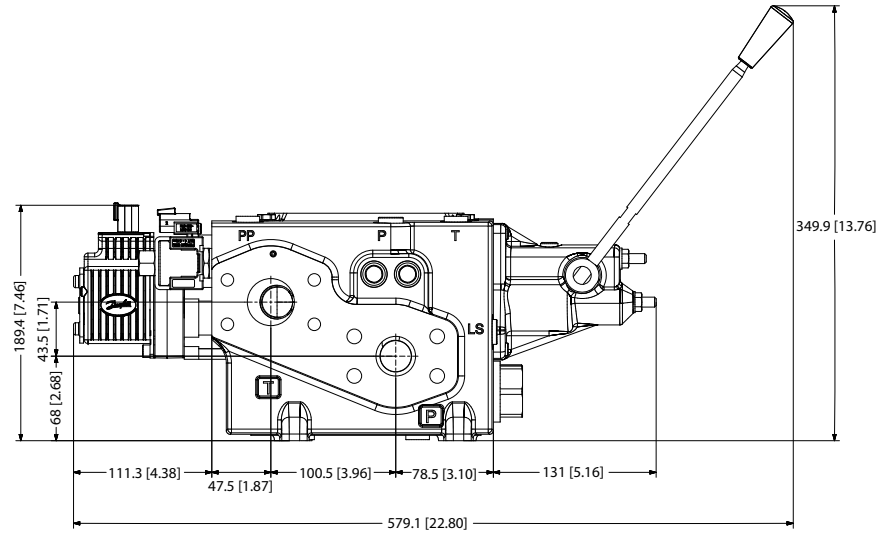

P109644

PVEH

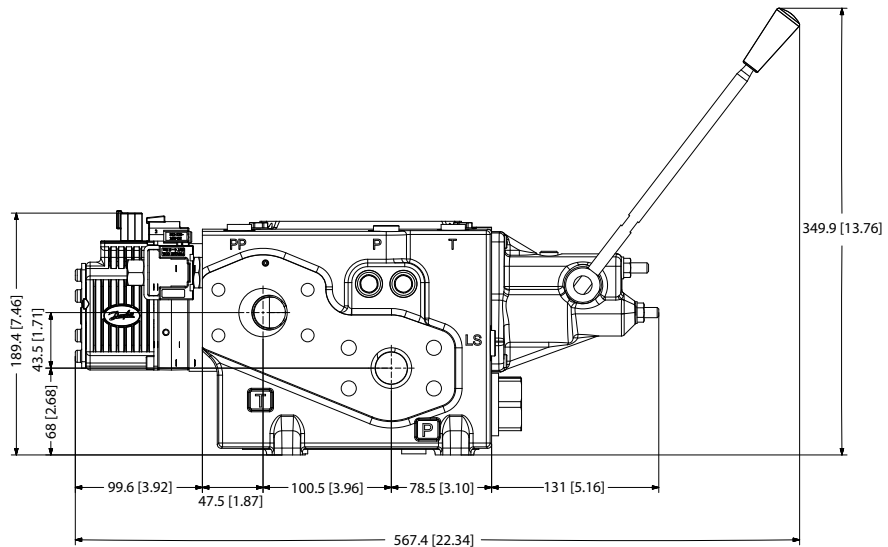

P109645

Technical Information
PVG 128/256 Technical Information

Dimension Overview

PVHC

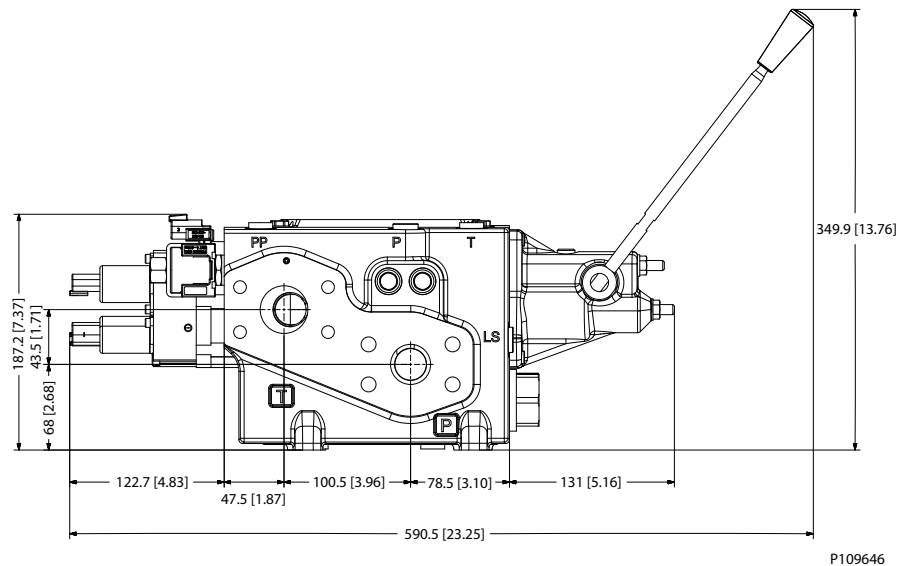

PVG 128/256 Dimensions

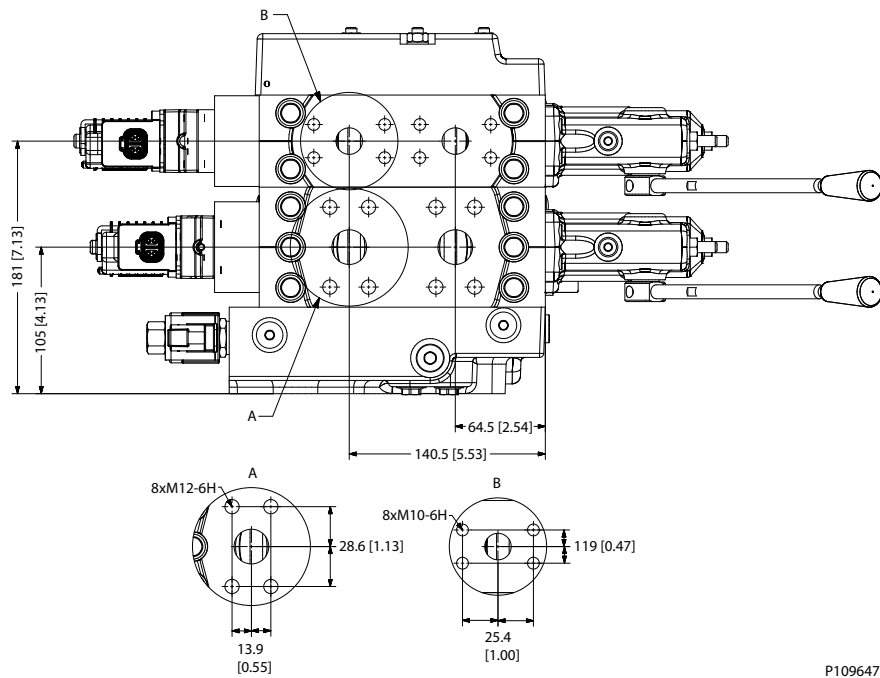

Dimension Overview

Number of PVB 256			Number of PVB 128									
			0	1	2	3	4	5	6	7	8	9
0	L1	mm	-	98.5	164.5	230.5	296.5	362.5	428.5	494.5	560.5	626.5
		[in]	-	[3.88]	[6.48]	[9.07]	[11.67]	[14.27]	[16.87]	[19.47]	[22.07]	[24.67]
	L2	mm	-	176.5	249.5	309.5	382.5	443.5	515.5	576.5	649.5	709.5
		[in]	-	[6.95]	[9.82]	[12.19]	[15.06]	[17.46]	[20.30]	[22.70]	[25.57]	[27.93]
1	L1	mm	118.5	184.5	250.5	316.5	382.5	448.5	514.5	580.5	646.5	-
		[in]	[4.67]	[7.26]	[9.86]	[12.46]	[15.06]	[17.66]	[20.26]	[22.85]	[25.45]	-
	L2	mm	200.5	273.5	334.5	406.5	467.5	540.5	600.5	673.5	734.5	-
		[in]	[7.89]	[10.77]	[13.17]	[16.00]	[18.41]	[21.28]	[26.64]	[26.52]	[28.92]	-
2	L1	mm	204.5	270.5	336.5	402.5	468.5	534.5	600.5	-	-	-
		[in]	[8.05]	[10.65]	[13.25]	[15.85]	[18.44]	[21.04]	[23.64]	-	-	-
	L2	mm	285.5	358.5	418.5	491.5	552.5	625.5	685.5	-	-	-
		[in]	[11.24]	[14.11]	[16.48]	[19.35]	[21.75]	[24.63]	[26.99]	-	-	-
3	L1	mm	290.5	356.5	422.5	488.5	554.5	520.5	-	-	-	-
		[in]	[11.44]	[14.04]	[16.63]	[19.23]	[21.83]	[24.43]	-	-	-	-
	L2	mm	370.5	443.5	503.5	576.5	637.5	709.5	-	-	-	-
		[in]	[14.59]	[17.46]	[19.82]	[22.70]	[25.10]	[27.93]	-	-	-	-
4	L1	mm	376.5	442.5	508.5	574.5	640.5	-	-	-	-	-
		[in]	[14.82]	[17.42]	[20.02]	[22.62]	[25.22]	-	-	-	-	-
	L2	mm	467.5	528.5	600.5	661.5	734.5	-	-	-	-	-
		[in]	[18.40]	[20.81]	[23.64]	[26.04]	[28.92]	-	-	-	-	-
5	L1	mm	462.5	528.5	594.5	660.5	-	-	-	-	-	-
		[in]	[18.21]	[20.81]	[23.41]	[26.00]	-	-	-	-	-	-
	L2	mm	552.5	612.5	685.5	746.5	-	-	-	-	-	-
		[in]	[21.75]	[24.11]	[26.99]	[29.39]	-	-	-	-	-	-
6	L1	mm	548.5	614.5	-	-	-	-	-	-	-	-
		[in]	[21.59]	[24.19]	-	-	-	-	-	-	-	-
	L2	mm	637.5	697.5	-	-	-	-	-	-	-	-
		[in]	[25.10]	[27.46]	-	-	-	-	-	-	-	-
7	L1	mm	634.5	-	-	-	-	-	-	-	-	-
		[in]	[24.98]	-	-	-	-	-	-	-	-	-
	L2	mm	722.5	-	-	-	-	-	-	-	-	-
		[in]	[28.44]	-	-	-	-	-	-	-	-	-

Technical Information
PVG 128/256 Technical Information
Dimension Overview
Specifications example

 Specification Sheet
 Valve type:

PVG 256 Combo

Subsidiary / Dealer	DPS XXX	Danfoss Sold-To Party No.			Customer	Shark Marine
Valve No.	Bxxxxxx	Customer Part No.		xxxxxxx	Application	Marine Crane
Filled in by	Mr. X	Date	07-04-2017	Revision No		EAU
Function	A-Port		B-Port			
1	PVLP 15782380	P=	11173130	PVPV 256	11160319	KIT PVPP
	PVLP 15782380			bar		
2	PVM 256 11175317	LSA=	11169243	PVB 256	11177058	PVBS
Boom up/down	PVLP 15782350		100	bar	315	bar
400 l/min CN	PVLP 15782350					15782350
	PVLP 15782350					15782350
3	PVM 256 11175317	LSA=	11165621	PVB 128	11178310	PVBS
Winch motor	PVLP 15782350		315	bar	315	bar
180 l/min ON	PVLP 15782350					15782350
			11171422	PVGI 256		
4		LSA=		bar		bar
5	PVM 15783171	LSA=	15786233	PVB	15787122	PVBS
Boom Swing	PVLP 15782350		250	bar	250	bar
40 l/min ON						15784292
			15782014	PVS		
6		LSA=		bar		bar
7		LSA=		bar		bar
8		LSA=		bar		bar
9		LSA=		bar		bar
10		LSA=		bar		bar
11		LSA=		bar		bar
12		LSA=		bar		bar
13		LSA=		bar		bar
14		LSA=		bar		bar
15		LSA=		bar		bar
18 PVAS	1. 11187677	2.	15788004	3.		
19 Painting						
20 Customer Text on Group Label						
21 Customer Text on Packaging Label (Box)						



Hydraulik · Automation



Technical Information

PVG 128/256 Technical Information



Hydraulik · Automation

Danfoss

Technical Information

PVG 128/256 Technical Information



Niehues

Hydraulik · Automation

ENGINEERING
TOMORROW



Products we offer:

- DCV directional control valves
- Electric converters
- Electric machines
- Electric motors
- Hydrostatic motors
- Hydrostatic pumps
- Orbital motors
- PLUS+1° controllers
- PLUS+1° displays
- PLUS+1° joysticks and pedals
- PLUS+1° operator interfaces
- PLUS+1° sensors
- PLUS+1° software
- PLUS+1° software services, support and training
- Position controls and sensors
- PVG proportional valves
- Steering components and systems
- Telematics

Danfoss Power Solutions is a global manufacturer and supplier of high-quality hydraulic and electric components. We specialize in providing state-of-the-art technology and solutions that excel in the harsh operating conditions of the mobile off-highway market as well as the marine sector. Building on our extensive applications expertise, we work closely with you to ensure exceptional performance for a broad range of applications. We help you and other customers around the world speed up system development, reduce costs and bring vehicles and vessels to market faster.

Danfoss Power Solutions – your strongest partner in mobile hydraulics and mobile electrification.

Go to www.danfoss.com for further product information.

We offer you expert worldwide support for ensuring the best possible solutions for outstanding performance. And with an extensive network of Global Service Partners, we also provide you with comprehensive global service for all of our components.

Comatrol

www.comatrol.com

Turola

www.turolaocg.com

Hydro-Gear

www.hydro-gear.com

Daikin-Sauer-Danfoss

www.daikin-sauer-danfoss.com

Local address:

Danfoss Power Solutions (US) Company
2800 East 13th Street
Ames, IA 50010, USA
Phone: +1 515 239 6000

Danfoss Power Solutions GmbH & Co. OHG
Krokamp 35
D-24539 Neumünster, Germany
Phone: +49 4321 871 0

Danfoss Power Solutions ApS
Nordborgvej 81
DK-6430 Nordborg, Denmark
Phone: +45 7488 2222

Danfoss Power Solutions Trading (Shanghai) Co., Ltd.
Building #22, No. 1000 Jin Hai Rd
Jin Qiao, Pudong New District
Shanghai, China 201206
Phone: +86 21 3418 5200

Danfoss can accept no responsibility for possible errors in catalogues, brochures and other printed material. Danfoss reserves the right to alter its products without notice. This also applies to products already on order provided that such alterations can be made without subsequent changes being necessary in specifications already agreed. All trademarks in this material are property of the respective companies. Danfoss and the Danfoss logotype are trademarks of Danfoss A/S. All rights reserved.