

The pilot operated valves are available in 4 sizes:

- D31DW NG10 (standard)
- D31NW NG10 (high flow)
- D41VW NG16
- D81VW NG25 (for port diameter up to 26 mm)
- D91VW NG25 (for port diameter up to 32 mm)
- D111VW NG32

All valves are piloted by a D1VW valve. Please see the separate ordering code for valves with position control. The minimum pilot pressure must be ensured for all operating conditions of the directional valve.

Additionally spools with a P to T connection in the de-energized position need an external pressure supply (external inlet) or an integral check valve.

Valves with explosion proof solenoids Ex e mb II see catalogue MSG11-3343/UK.

Download of the PDF file at [www.parker.com/ISDE](http://www.parker.com/ISDE), see "Support".

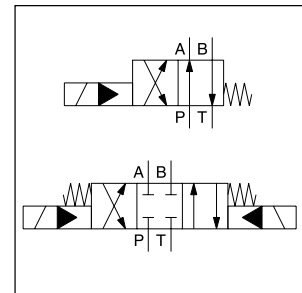

D31DW

**2**



D31NW



D41VW

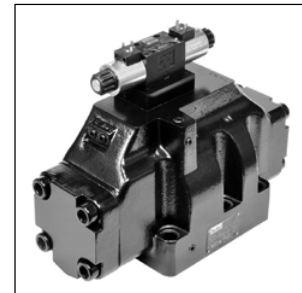

D81VW

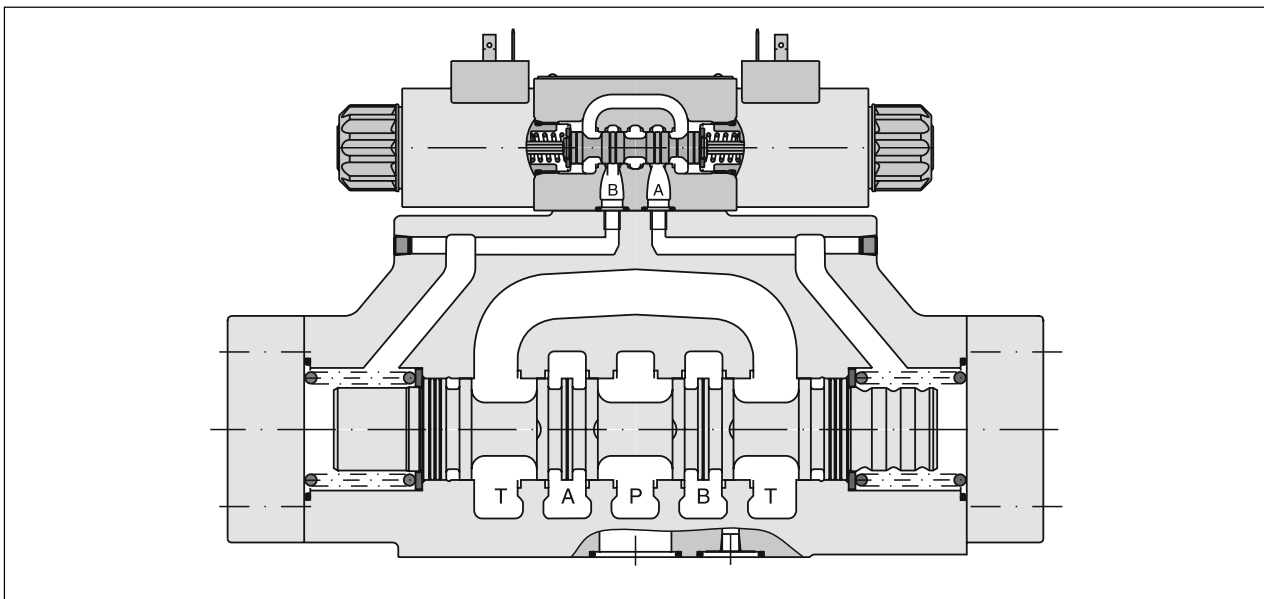

D111VW

**D81VW**

**2**

Code	Bore	Size	Feature
D31DW	Ø11 mm	NG10	
D31NW	Ø11 mm	NG10	High flow
D41VW	Ø20 mm	NG16	
D81VW	Ø26 mm	NG25	
D91VW	Ø32 mm	NG25	High flow
D111VW	Ø50 mm	NG32	

3 position spools		D31D	D31N	D41	D81/91	D111
Code	Spool type					
001		•	•	•	•	•
002		•	•	•	•	•
003		•	•	•	•	•
004		•	•	•	•	•
005		•	•	•	•	•
006		•	•	•	•	•
007		•	•	•	•	•
009 <sup>1)</sup>		•	•	•	•	•
011		•	•	•	•	•
014		•	•	•	•	•
015		•	•	•	•	•
016		•	•	•	•	•
021		•	•	•	•	•
022		•	•	•	•	•
031		•	•	•	•	•
032		•	•	•	•	•
054				•	•	•
081		•	•	•	•	•
082		•	•	•	•	•

2 position spools		D31D	D31N	D41	D81/91	D111
Code	Spool type					
020		•	•	•	•	•
026		•	•	•	•	•
030		•	•	•	•	•

<sup>1)</sup> Consider specific spool position.  
<sup>2)</sup> For D31NW and D111VW only pilot valve with detent available.  
<sup>3)</sup> D31DW\*D/R/S is not available with accessories 3D, 3E or 3F.  
<sup>4)</sup> Not for D31DW, D91VW and D111VW available.  
<sup>5)</sup> Not for spools 002, 007, 009, 014, 030, 031, 032, 054 available.  
<sup>6)</sup> To be used in combination with rectifier plugs at 120 VAC / 230 VAC power supply.  
<sup>7)</sup> Only D31, D41, D81, D91 available.

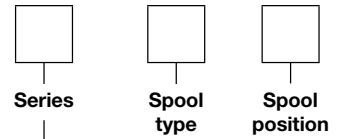

3 position spools		
Code	Spool position	
<b>C</b>		<b>3 positions.</b> Spring offset in position "0". Operated in position "a" or "b".
	Standard	Spool type 009
<b>E</b>	 Operated in position "a".	 Operated in position "b". 2 positions. Spring offset in position "0".
<b>F</b>	 Spring offset in position "b".	 Spring offset in position "a". 2 positions. Operated in position "0".
<b>K</b>	 Operated in position "b".	 Operated in position "a". 2 positions. Spring offset in position "0".
<b>M</b>	 Spring offset in position "a".	 Spring offset in position "b". 2 positions. Operated in position "0".
<b>R</b> <sup>2)3)</sup>	 No center in offset position.	 No center in offset position. 2 positions, detent. Operated in position "0" or "b".
<b>S</b> <sup>2)3)</sup>	 No center in offset position.	 No center in offset position. 2 positions, detent. Operated in position "0" or "a".

2 position spools		
Code	Spool position	
<b>B</b>		<b>Spring offset in position "b".</b> <b>Operated in position "a".</b>
<b>D</b> <sup>2)3)</sup>	 No center in offset position.	Detent, operated in position "a" or "b".
<b>H</b>		Spring offset in position "a". Operated in position "b".

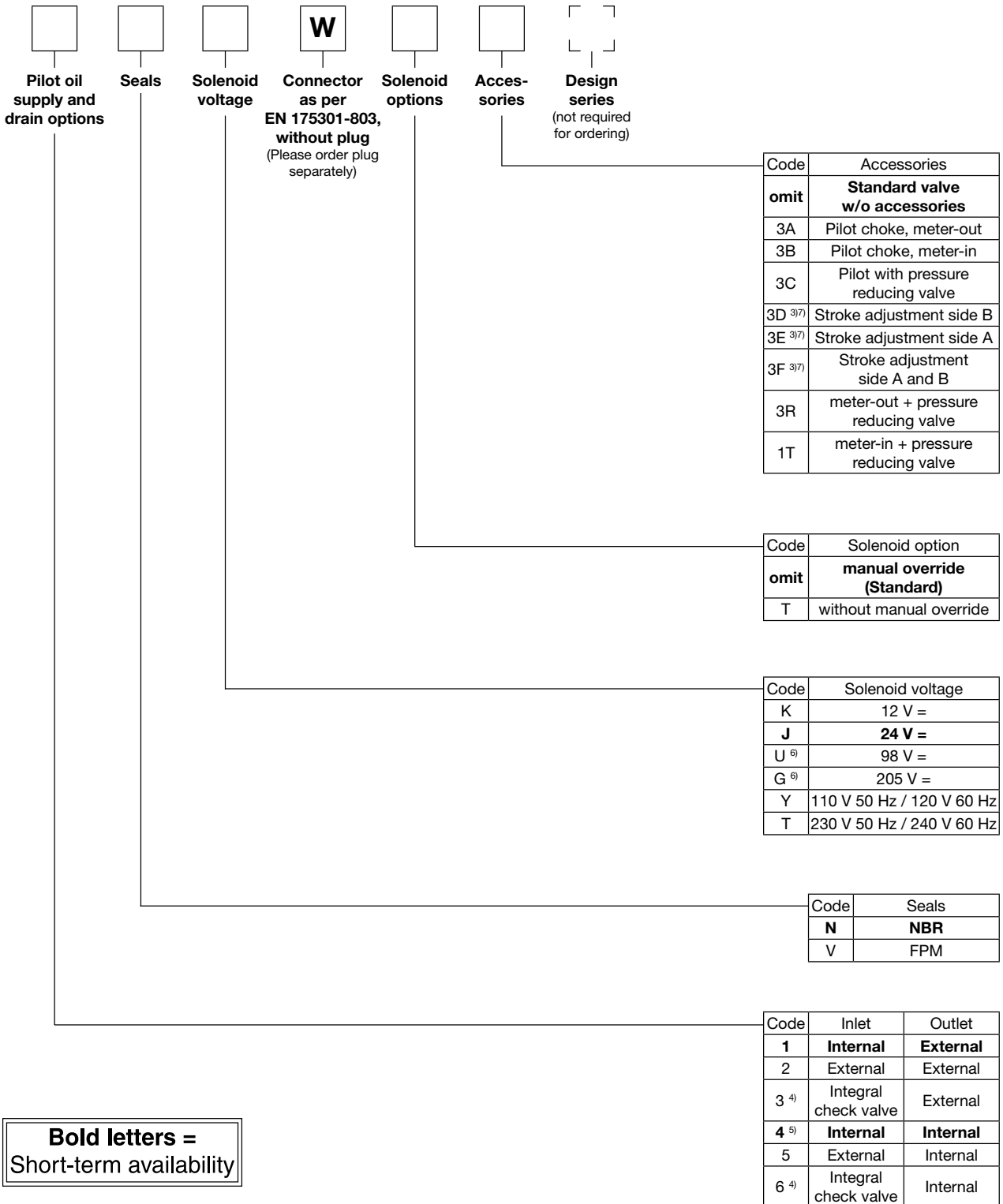
**2**

**Bold letters =**  
 Short-term availability

Further spool types and solenoid voltages on request.  
 Explosion proof solenoids Ex e mb II see catalogue MSG11-3343/UK.  
 Download of the PDF file at [www.parker.com/ISDE](http://www.parker.com/ISDE), see „Support“.

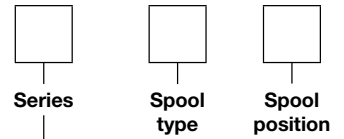
**2**

Code	Bore	Size	Feature
D31DW	Ø11 mm	NG10	
D31NW	Ø11 mm	NG10	High flow
D41VW	Ø20 mm	NG16	
D81VW	Ø26 mm	NG25	
D91VW	Ø32 mm	NG25	High flow
D111VW	Ø50 mm	NG32	

3 position spools		D31D	D31N	D41	D81/91	D111
Code	Spool type					
001	a 0 b	•	•	•	•	•
002		•	•	•	•	•
003		•	•	•	•	
004		•	•	•	•	•
005			•	•	•	
006			•	•	•	
007				•	•	
009 <sup>1)</sup>		•	•	•	•	•
011		•	•	•	•	
014				•	•	
015		•	•	•	•	
016			•	•	•	
021		•	•	•	•	
022		•	•	•	•	
031					•	
032					•	
054				•	•	•
081				•	•	•
082				•	•	•

2 position spools		D31D	D31N	D41	D81/91	D111
Code	Spool type					
020	a b	•	•	•	•	•
026		•		•	•	
030		•	•	•	•	•

3 position spools		
Code	Spool position	
C		3 positions. Spring offset in position "0". Operated in position "a" or "b".
	Standard	Spool type 009
E		2 positions. Spring offset in position "0".
F <sup>2)</sup>		2 positions. Operated in position "0".
K		2 positions. Spring offset in position "0".
M <sup>2)</sup>		2 positions. Operated in position "0".

2 position spools		
Code	Spool position	
B		Spring offset in position "b". Operated in position "a".
H		Spring offset in position "a". Operated in position "b".

**Attention:**  
 The adjustment of the position control is factory set and sealed.  
 Replacement and repairs can only be undertaken by the manufacturer.

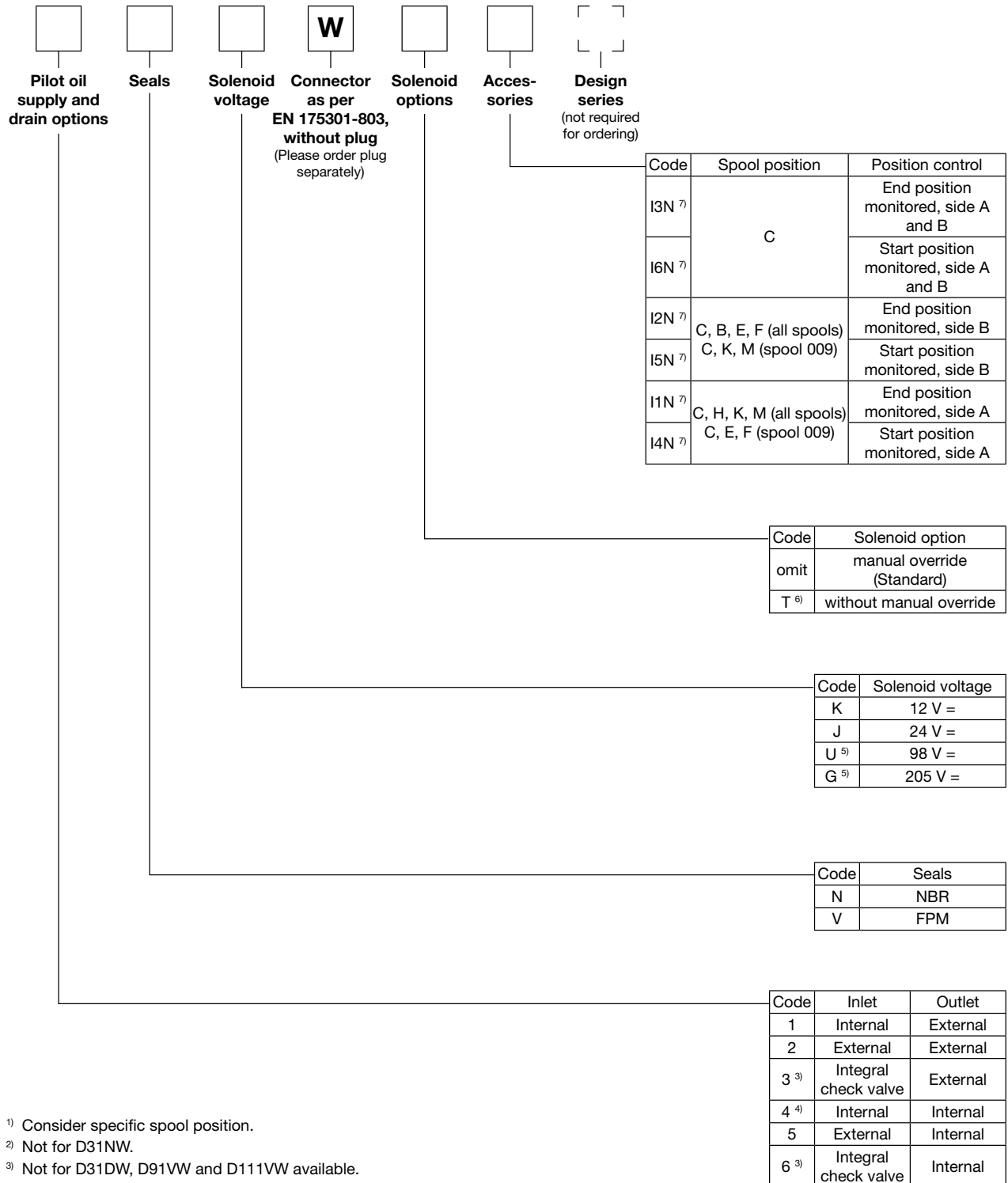
**2**
<sup>1)</sup> Consider specific spool position.

<sup>2)</sup> Not for D31NW.

<sup>3)</sup> Not for D31DW, D91VW and D111VW available.

<sup>4)</sup> Not for spools 002, 007, 009, 014, 030 available.

<sup>5)</sup> To be used in combination with rectifier plugs at 120 VAC / 230 VAC power supply.

<sup>6)</sup> For hydraulic presses according to the safety regulations EN 693, solenoid option "T" (without manual override) and accessories "I4N", "I5N" or "I6N" (start position monitored) are required.

<sup>7)</sup> Please order female connector M12x1 separately (see accessories, female connector M12x1 (order no.: 5004109). The monitor switch has to be located on the side to which the spool moves from the spring offset position. For 4/3-way valves two switches are required.

**2**

General						
Design	Directional spool valve					
Actuation	Solenoid					
Series	D31DW	D31NW	D41VW	D81/91VW	D111VW	
Size	NG10	NG10	NG16	NG25	NG32	
Weight (1/ 2 solenoids) [kg]	6.0 / 6.6	7.6 / 8.1	9.7 / 10.3	17.9 / 18.6	67.4 / 68.0	
Mounting interface	DIN 24340 A10	DIN 24340 A10	DIN 24340 A16	DIN 24340 A25	DIN 24340 A32	
	ISO 4401	ISO 4401	ISO 4401	ISO 4401	ISO 4401	
	NFPA D05	NFPA D05	NFPA D07	NFPA D08	NFPA D10	
CETOP RP 121-H						
Mounting position	unrestricted, preferably horizontal					
Ambient temperature [°C]	-25...+60 (without inductive position control)					
	-20...+60 (with inductive position control)					
MTTF <sub>p</sub> value [years]	75					
Hydraulic						
Max. operating pressure [bar]	Pilot drain internal: P, A B, X: 350; T, Y: 105					
	Pilot drain external: P, A B, T, X: 350; Y: 105					
Fluid	Hydraulic oil according to DIN 51524					
Fluid temperature [°C]	-20 ... +70 (NBR: -25...+70), (without inductive position control)					
	-20...+70 (with inductive position control)					
Viscosity permitted [cSt] [mm <sup>2</sup> /s]	2.8...400					
Viscosity recommended [cSt] [mm <sup>2</sup> /s]	30...80					
Filtration	ISO 4406 (1999); 18/16/13					
Flow max. [l/min]	150	170	300	700	2000	
Leakage at 350 bar (per flow path) [ml/min]	up to 100*	72...422*	up to 200*	up to 800*	up to 5000*	
*depending on spool						
Opening pressure integral check valve [bar]	n.a.	see p/Q diagram	see p/Q diagram	see p/Q diagram	n.a.	
Minimum pilot supply pressure [bar]	5	7		5		
Static / Dynamic						
Step response at 95 % [ms]	Energized / De-energized					
DC solenoids Pilot pressure	50 bar	60 / 40	50 / 60	95 / 65	150 / 170	470 / 390
	100 bar	55 / 40	50 / 60	75 / 65	110 / 170	320 / 390
	250 bar	55 / 40	50 / 50	60 / 65	90 / 170	210 / 390
	350 bar	55 / 40	50 / 50	60 / 65	85 / 170	200 / 390
AC solenoids Pilot pressure	50 bar	40 / 30	30 / 50	75 / 55	130 / 155	450 / 375
	100 bar	35 / 30	30 / 50	65 / 55	90 / 155	300 / 375
	250 bar	35 / 30	30 / 50	40 / 55	70 / 155	190 / 375
	350 bar	35 / 30	30 / 50	40 / 55	65 / 155	180 / 375
Electrical characteristics						
Duty ratio	100 % ED; CAUTION: coil temperature up to 150 °C possible					
Protection class	IP65 in accordance with EN 60529 (with correctly mounted plug-in connector)					
Code	K	J	U	G	Y	T
	12 V =	24 V =	98 V =	205 V =	110 V at 50 Hz/ 120 V at 60 Hz	230 V at 50 Hz/ 240 V at 60 Hz
Supply voltage / ripple [V]						
Tolerance supply voltage [%]	±10	±10	±10	±10	±5	±5
Current consumption hold [A]	2.72	1.29	0.33	0.13	0.58 / 0.49	0.31 / 0.26
Current consumption in rush [A]	2.72	1.29	0.33	0.13	2.1 / 2.0	1.05 / 1.0
Power consumption hold	32.7 W	31 W	31.9 W	28.2 W	64 / 59 VA	68 / 62 VA
Power consumption in rush	32.7 W	31 W	31.9 W	28.2 W	231 / 240 VA	231 / 240 VA
Solenoid connection	Connector as per EN 175301-803, solenoid identification as per ISO 9461.					
Wiring min. [mm <sup>2</sup> ]	3 x 1.5 recommended					
Wiring length max. [m]	50 recommended					

With electrical connections the protective conductor (PE ⚡) must be connected according to the relevant regulations.

**Electrical characteristics of position control as per IEC 61076-2-101 (M12x1), NG16/NG25/NG32**

Supply voltage	[VDC]	24
Tolerance supply voltage	[%]	±20
Ripple supply voltage	[%]	≤10
Polarity protection	[V]	300
Current consumption without load	[mA]	≤20
Switching hysteresis	[mm]	<0.06
Max. output current per channel, ohmic	[mA]	250
Ambient temperature	[°C]	-20 ... +60
Protection		IP65 acc. EN 60529 (with correctly mounted plug-in connector)
Min. distance to next AC solenoid	[m]	0.1
Interface		M12x1 to IEC 61076-2-101
CE conform		EN 61000-4-2 / EN 61000-4-4 / EN 61000-4-6 <sup>1)</sup> / ENV 50140 / ENV 50204

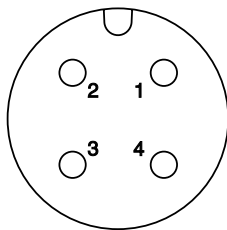
**2**
**M12 pin assignment**

- 1 + US 19.2...28.8 V
- 2 Out B: normally open
- 3 0 V
- 4 Out A: normally closed

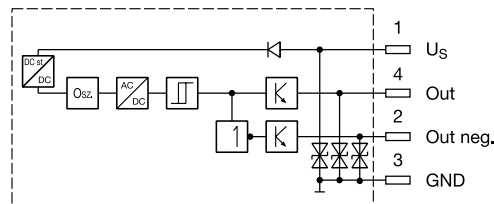

Outputs: Open collector

**Definitions**
**Start position monitored:**

The valve is de-energized. The inductive switch gives a signal at the moment when the spool leaves the spring offset position (below 15 % spool stroke).

At the switching point the spool is located within the closed position. It is secured that only the flow paths of the offset position are granted.

**End position monitored:**

The inductive switch gives a signal before the end position is reached (above 85 % spool stroke).

Please order plug M12x1 separately (see accessories, plug M12x1; order no.: 5004109).

<sup>1)</sup> Only guaranteed with screened cable and female connector



The flow curve diagrams show the flow versus pressure drop curves for all spool types. The relevant curve

number for each spool type, operating position and flow direction is given in the tables below.

**2**
**D31DW and D31NW**

Spool Code	Curve number									
	P-A		P-B		P-T		A-T		B-T	
	*DW	*NW	*DW	*NW	*DW	*NW	*DW	*NW	*DW	*NW
001	4	3	4	3	-	-	3	2	3	5
002	2	3	3	3	3	7	3	4	4	3
003	2	2	4	3	-	-	1	4	2	4
004	4	2	3	3	-	-	2	4	3	4
005	1	2	4	4	-	-	2	1	3	4
006	2	8	3	9	-	-	3	7	4	9
007	4	-	2	-	5	-	2	-	2	-
009	2	4	2	6	8	6	5	4	6	10
011	3	3	2	3	-	-	3	2	3	4
014	2	-	4	-	5	-	2	-	3	-
015	4	2	2	2	-	-	2	1	2	4
016	4	4	1	3	-	-	1	2	2	4
020	4	6	4	4	-	-	4	3	4	6
021	3	-	4	7	-	-	2	8	-	-
022	5	4	2	-	-	-	-	9	4	-
026	3	-	3	-	-	-	-	-	-	-
030	4	5	3	3	-	-	3	2	3	5
031	3	-	4	-	-	-	1	-	-	-
032	5	-	2	-	-	-	-	-	2	-
081	6	-	6	-	-	-	7	-	7	-
082	7	-	6	-	-	-	5	-	7	-

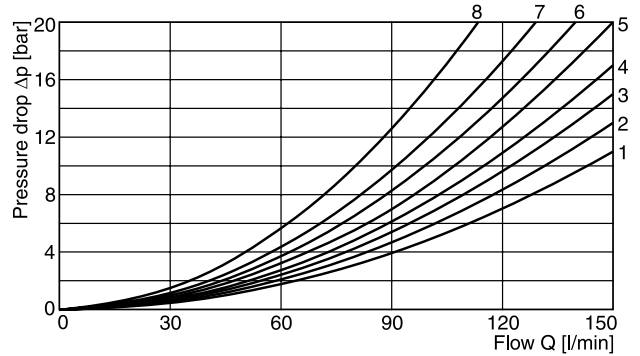
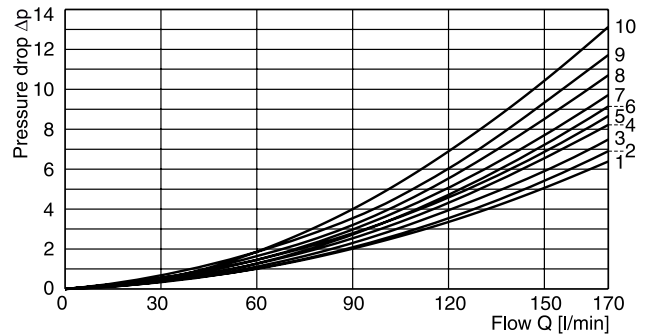
**D31DW**

**D31NW**

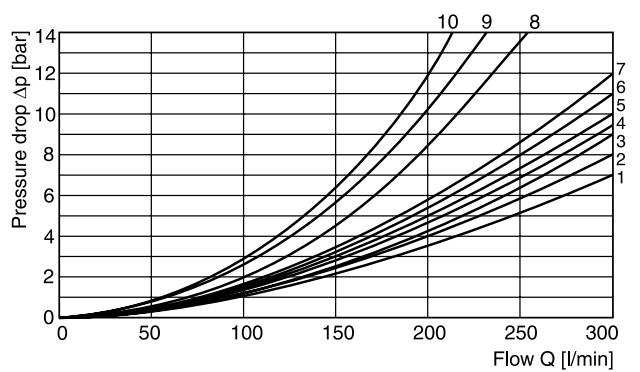
**D41VW**

Spool Code	Curve number				
	P-A	P-B	P-T	A-T	B-T
001	1	1	-	4	5
002	1	2	6	4	6
003	1	2	-	5	6
004	1	1	-	5	5
005	2	2	-	3	5
006	1	2	-	3	6
007	1	1	6	4	5
009	2	9	8	7	10
011	1	1	-	4	5
014	1	1	6	4	5
015	1	2	-	4	6
016	2	2	-	3	5
020	3	5	-	3	5
021	2	8	-	2	-
022	8	2	-	-	3
026	3	5	-	-	-
030	2	3	-	6	7
031	-	-	-	-	-
032	-	-	-	-	-
054	2	3	-	6	7
081	-	-	-	-	-
082	-	-	-	-	-

**D41VW**

All characteristic curves measured with HLP46 at 50 °C.



**D81/D91VW and D111VW**

Spool Code	Curve number									
	P-A		P-B		P-T		A-T		B-T	
	D8/9	D11	D8/9	D11	D8/9	D11	D8/9	D11	D8/9	D11
001	3	5	2	5	-	-	3	4	5	1
002	2	5	1	5	1	5	3	4	5	1
003	4	-	2	-	-	-	3	-	6	-
004	4	5	3	5	-	-	3	4	5	1
005	1	-	2	-	-	-	4	-	5	-
006	2	-	2	-	-	-	4	-	6	-
007	3	-	1	-	7	-	3	-	5	-
009	4	3	8	3	9	2	4	3	10	1
011	3	-	2	-	-	-	3	-	5	-
014	1	-	2	-	8	-	3	-	5	-
015	3	-	3	-	-	-	4	-	5	-
016	3	-	3	-	-	-	4	-	5	-
020	6	5	5	5	-	-	6	3	8	1
021	5	-	10	-	-	-	3	-	-	-
022	10	-	5	-	-	-	-	-	5	-
026	6	-	5	-	-	-	-	-	-	-
030	3	5	2	5	-	-	3	4	5	1
054	4	5	3	5	-	-	3	4	5	1

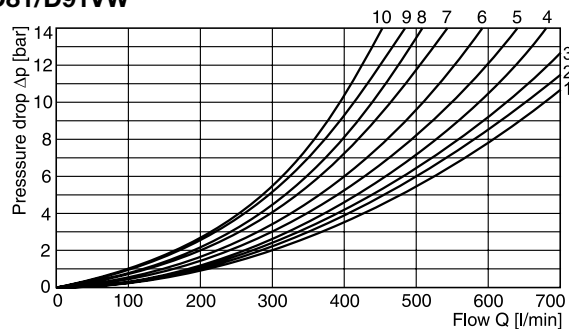
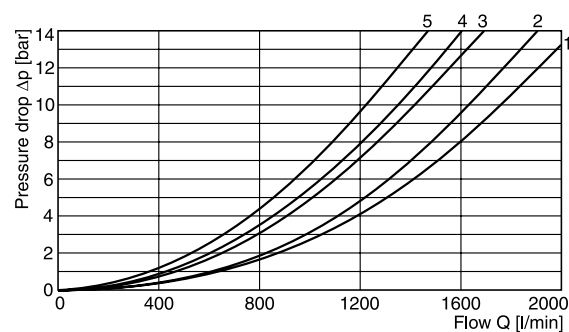
**D81/D91VW**

**D111VW**

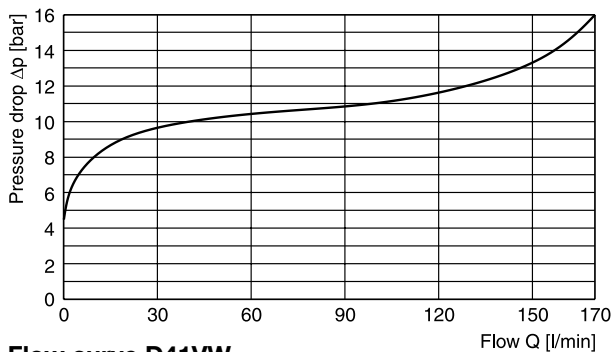
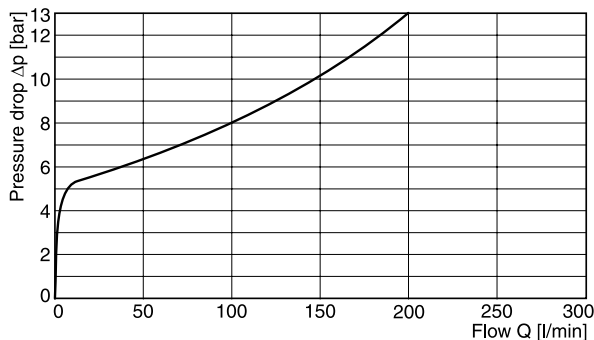
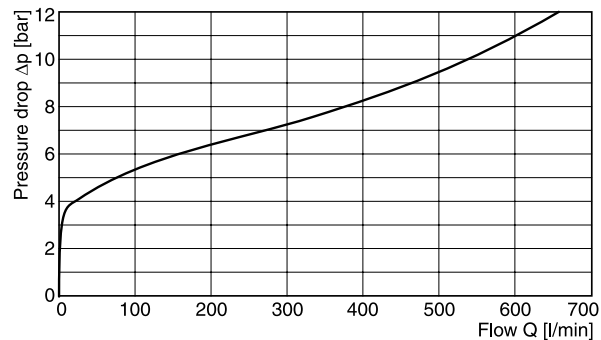
**2**
**Integral check valve in the P port**

Mounting an integral check valve in the P port is necessary to build up pilot pressure for valves with P to T connection and internal pilot oil supply. The pressure difference at the integral check valve (see performance curves) is to be added to all flow curves of the P-port of the main valve. Directional valves with an integral check valve are available for the series D31NW, D41VW and D81VW.

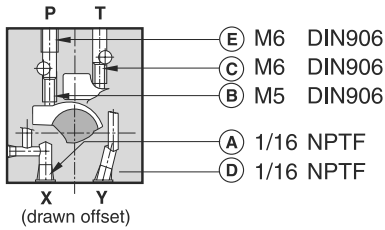
**Flow curve D31NW**

**Flow curve D41VW**

**Flow curve D81VW**

All characteristic curves measured with HLP46 at 50 °C.

**2**
**D31DW**

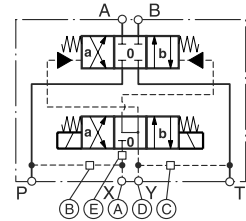
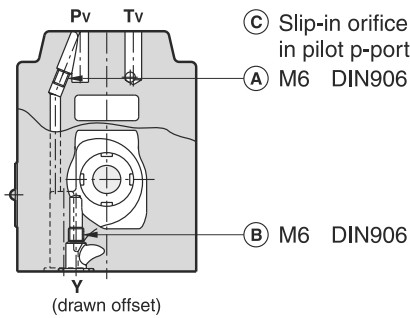
○ open, ● closed

Pilot oil		A	B	C	D	E
Inlet	Outlet					
internal	external	●	○	●	○	Orifice Ø1.2
external	external	○	●	●	○	Orifice Ø1.2
internal	internal	●	○	○	●	Orifice Ø1.2
external	internal	○	●	○	●	Orifice Ø1.2

**D31NW**

○ open, ● closed

Pilot oil		A	B	C
Inlet	Outlet			
internal	external	○	●	Orifice Ø1.0
external	external	●	●	Orifice Ø1.0
internal	internal	○	○	Orifice Ø1.0
external	internal	●	○	Orifice Ø1.0

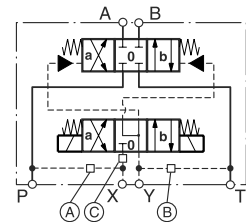
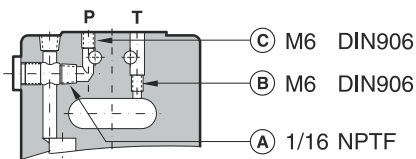
**D41VW**

○ open, ● closed

Pilot oil		A	B	C
Inlet	Outlet			
internal	external	○	●	Orifice Ø1.5
external	external	●	●	Orifice Ø1.5
internal	internal	○	○	Orifice Ø1.5
external	internal	●	○	Orifice Ø1.5

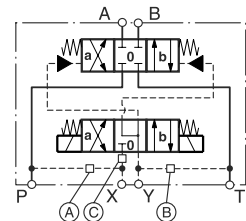
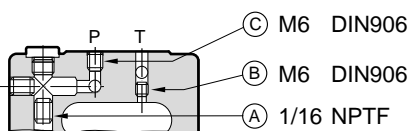
**D81/91VW**

○ open, ● closed

Pilot oil		A	B	C
Inlet	Outlet			
internal	external	○	●	Orifice Ø1.5
external	external	●	●	Orifice Ø1.5
internal	internal	○	○	Orifice Ø1.5
external	internal	●	○	Orifice Ø1.5

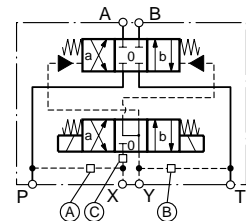
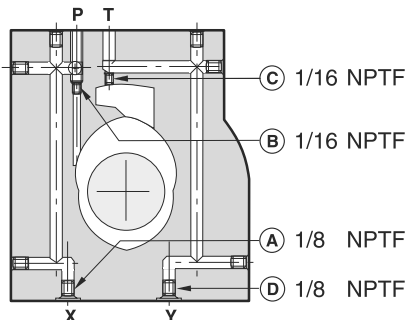
**D111VW**

○ open, ● closed



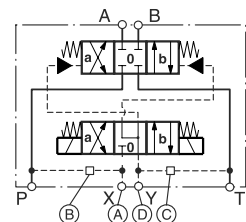

Pilot oil		A	B	C	D
Inlet	Outlet				
internal	external	○	Orifice Ø1.5	●	○
external	external	Orifice Ø1.5	●	●	○
internal	internal	○	Orifice Ø1.5	○	○
external	internal	Orifice Ø1.5	●	○	○



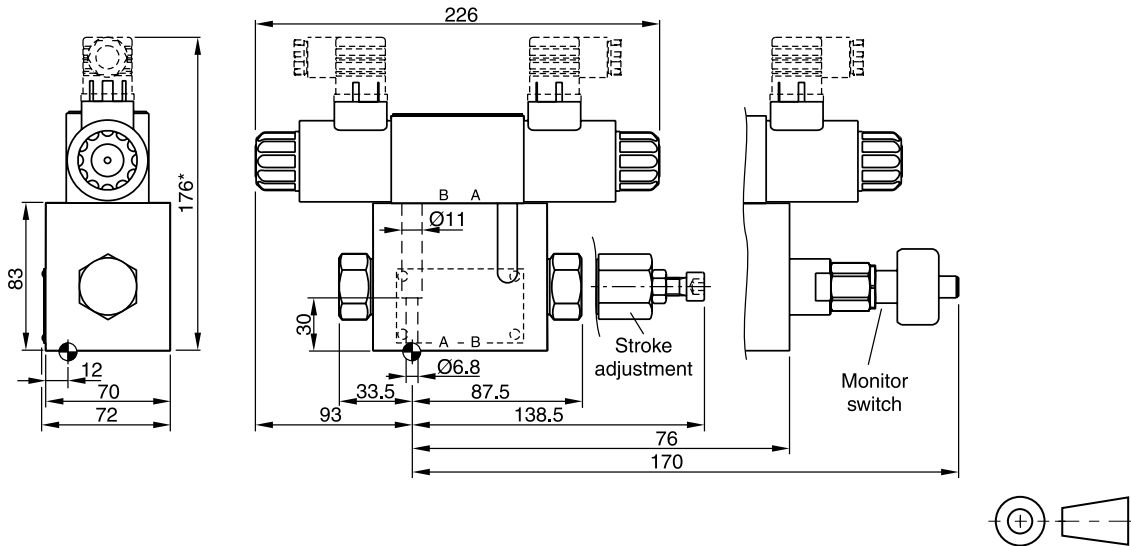

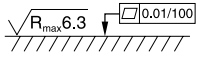

All orifice sizes for standard valves.

D3-D11 UK.indd 08.05.20

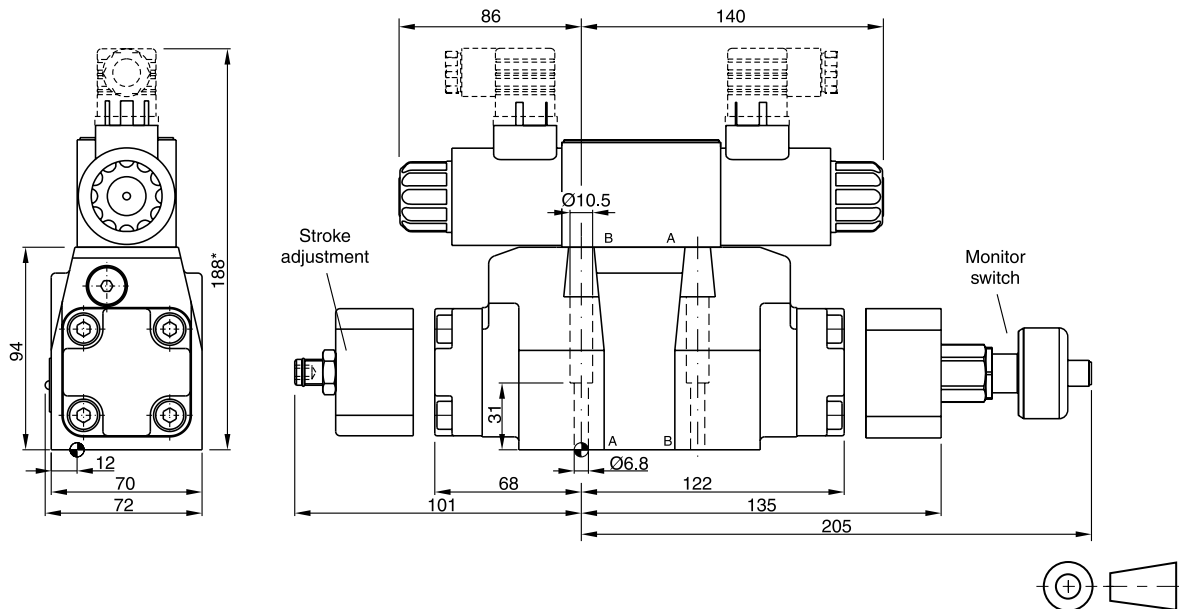
**D31DW**

**2**

Surface finish	 Kit	 Kit	 Kit	 Kit
	BK385	4x M6x40 ISO 4762-12.9	13.2 Nm ±15 %	<b>NBR: SK-D31DW-N-91</b> FPM: SK-D31DW-V-91

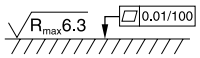



**D31NW**

Surface finish	 Kit	 Kit	 Kit	 Kit
	BK385	4x M6x40 ISO 4762-12.9	13.2 Nm ±15 %	<b>NBR: SK-D31NW-N-91</b> FPM: SK-D31NW-V-91

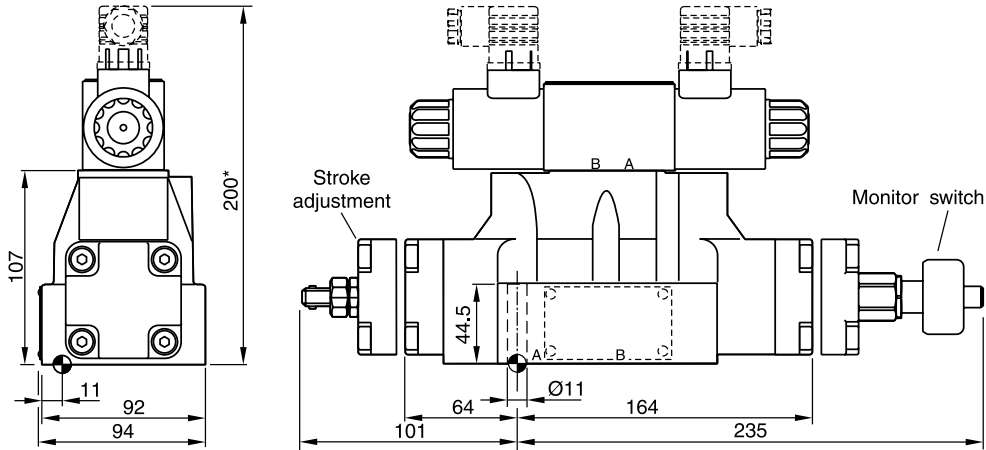

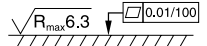

The space necessary to remove the plug per EN 175301-803, design type AF is at least 15 mm.  
 The torque for the screw M3 of the plug has to be 0.5 to 0.6 Nm.

\* Please add for each sandwich plate +40 mm (pressure reducing valve, choke valve meter-in/-out).

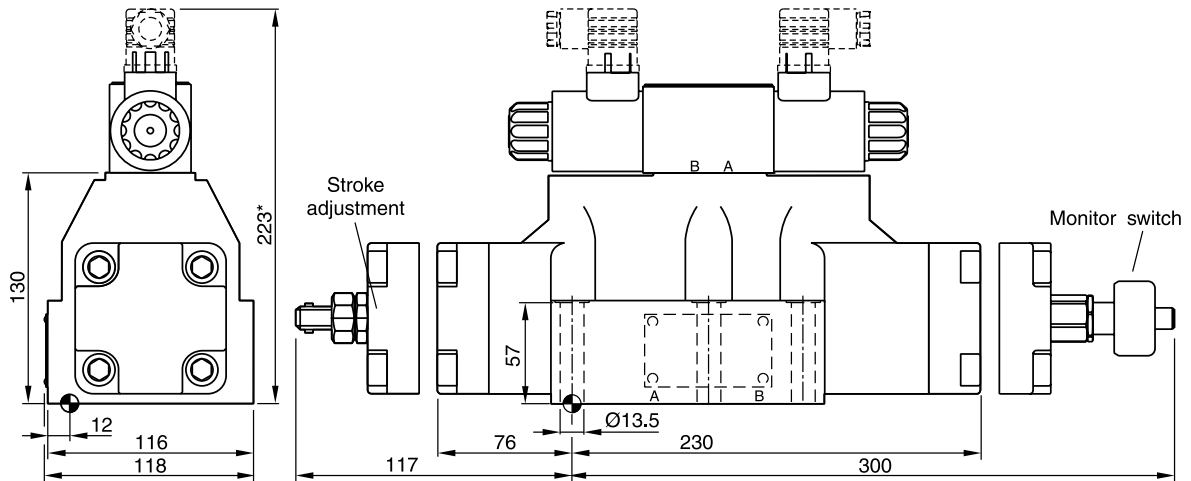
**D41VW**
**2**

Surface finish	 Kit	 Kit	 Kit	 Kit
	BK320	4x M10x60 2x M6x55 ISO 4762-12.9	63 Nm ± 15 % 13.2 Nm ± 15 %	<b>NBR: SK-D41VW-N-91</b> FPM: SK-D41VW-V-91

**D81VW, D91VW**

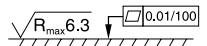



Surface finish	 Kit	 Kit	 Kit	 Kit
	BK360	6x M12x75 ISO 4762-12.9	108 Nm ± 15 %	<b>NBR: SK-D81VW-N-91 / SK-D91VW-N-91</b> FPM: SK-D81VW-V-91 / SK-D91VW-V-91

The space necessary to remove the plug per EN 175301-803, design type AF is at least 15 mm.  
 The torque for the screw M3 of the plug has to be 0.5 to 0.6 Nm.

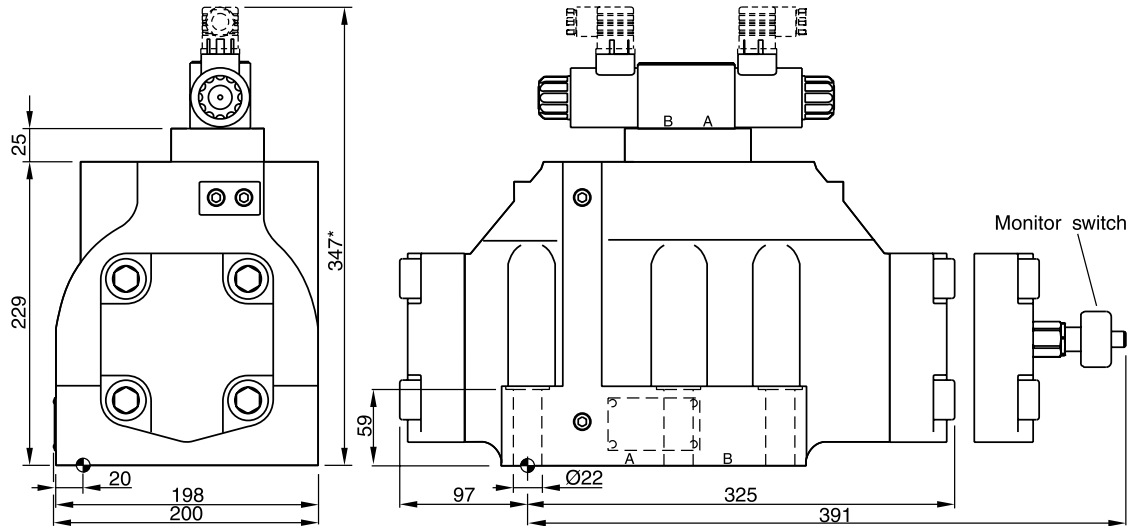
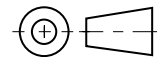
\* Please add for each sandwich plate +40 mm (pressure reducing valve, choke valve meter-in/-out).

D3-D11 UK.indd 08.05.20

**D111VW**

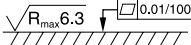
**2**

Surface finish	 Kit	 Kit	 Kit	 Kit
	BK386	6x M20x90 ISO 4762-12.9	517 Nm ±15 %	<b>NBR: SK-D111VW-N-91</b> FPM: SK-D111VW-V-91

The space necessary to remove the plug as per EN 175301-803, design type AF is at least 15 mm.  
 The torque for the screw M3 of the plug has to be 0.5 to 0.6 Nm.

\* Please add for each sandwich plate +40 mm (pressure reducing valve, choke valve meter-in/-out).

D3-D11 UK.indd 08.05.20