

HYDAC INTERNATIONAL

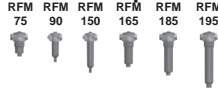

Return Line Filter RFM with 2-Hole Mounting

Tank-top versions: up to 200 l/min, up to 10 bar



In-tank versions: up to 2,600 l/min, up to 10 bar



1. TECHNICAL SPECIFICATIONS

1.1 FILTER HOUSING

Construction

The filter housings are designed in accordance with international regulations. They consist of a filter head (with 2-hole flange), filter bowl and a screw-on cover plate.

Standard equipment:

- with bypass valve
- connection for a clogging indicator (Important: for RFM 75 to 195, please state mounting position for indicator!)

1.2 FILTER ELEMENTS

HYDAC filter elements are validated and their quality is constantly monitored according to the following standards:

- ISO 2941, ISO 2942, ISO 2943
ISO 3724, ISO 3968, ISO 11170
ISO 16889

Filter elements are available with the following pressure stability values:

Optimicron® (ON):	20 bar
Ecomicron® (ECON2):	10 bar
Wire mesh (W/HC):	20 bar
Paper (P/HC):	10 bar
Betamicron® / Aquamicron® (BN4AM):	10 bar
Aquamicron® (AM):	10 bar
Mobilemicron® (MM):	10 bar

1.3 FILTER SPECIFICATIONS

Nominal pressure	10 bar
Temperature range	-30 °C to +100 °C (short-term: -40 °C)
Material of filter head	Aluminium: all RFM
Material of filter bowl	Polyamide: all RFM except 210, 270
Material of cover plate	Polyamide: all RFM
Type of clogging indicator	VMF Connection thread G 1/8 (return line indication)
Pressure setting of the clogging indicator	2 bar (others on request)
Bypass cracking pressure	3 bar (others on request)

1.4 SEALS

NBR (=Perbunan)

1.5 MOUNTING

Tank-top or in-tank filter

1.6 SPECIAL MODELS AND ACCESSORIES

- Extension tube (except RFM 90, 150) on request
- Tank breather filter built into head on RFM 75 to 195
- Dipstick for RFM 75, 165, 185, 195 (RFM 90 and 150 on request)
- 4-hole flange (see brochure "Return Line Filter RFM with 4-hole mounting")

1.7 SPARE PARTS

See Original Spare Parts List

1.8 CERTIFICATES AND APPROVALS

On request

1.9 COMPATIBILITY WITH HYDRAULIC FLUIDS ISO 2943

- Hydraulic oils H to HLPD DIN 51524
- Lubrication oils DIN 51517, API, ACEA, DIN 51515, ISO 6743
- Compressor oils DIN 51506
- Biodegradable operating fluids VDMA 24568 HETG, HEES, HEPG
- Fire-resistant fluids HFA, HFB, HFC and HFD
- Operating fluids with high water content (>50% water content) on request

1.10 IMPORTANT INFORMATION

- Filter housings must be earthed
- When using electrical clogging indicators, the electrical power supply to the system must be switched off before removing the clogging indicator connector
- If an extension tube is to be fitted to the two-piece filter housing, the tube must be made of synthetic material or thin-wall aluminium
- Extensions must be protected by fitting a bulkhead plate or other means of protection so that no forces can be transmitted to the filter housing or the extension
- The filter can normally only be used for tank-mounting
- The filter must be fitted absolutely vertically, or after consultation with the manufacturer, only within the tolerances specified
- The filter must not be used as a suction filter
- Components (e.g. coolers) must not be installed after the filter

Symbol for hydraulic systems

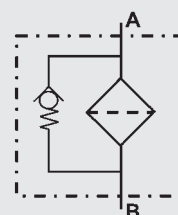

2. MODEL CODE (also order example)

2.1. COMPLETE FILTER: TANK-TOP VERSION

RFM ON 165 B C 10 D 1 . X /-L24
Filter type

RFM

Filter material

 ON Optimicron®
 ECO/N Ecomicron® (ECON2) – not RFM SET version 2600
 P/HC paper
 W/HC stainless steel wire mesh
 MM Mobilemicron

Size of filter or element

RFM: 75, 90, 150, 165, 185, 195

Operating pressure

 B = 10 bar
 V = 7 bar (for RFM with clogging indicator up to max. 7 bar operating pressure)

Type and size of connection

Type	Port	Filter size						KIT, SET, S versions see point 2.5
		75	90	150	165	185	195	
B	G ½	●	X	X	●	●	●	X on request
C	G ¾	●	●	●	●	●	●	
D	G 1	●	X	X	●	●	●	

Filtration rating in µm

 ON: 1, 3, 5, 10, 15, 20 ECO/N: 3, 5, 10, 20 W/HC: 25, 50, 100, 200
 P/HC: 10, 20 MM: 10, 15

Type of clogging indicator

 Y plastic cap in indicator port
 A screw plug in indicator port
 B visual
 C electrical
 D visual and electrical
 for other clogging indicators
 see brochure no. 7.050../..

Type code

 0 without port, no clogging indicator
 1-3 see point 2.4 - note position of clogging indicator!

Modification number

X the latest version is always supplied

Supplementary details

 A..B.. setting pressure of indicator and cracking pressure of bypass in bar (e.g.: A5-B6)
 L... light with appropriate voltage (24, 48, 110, 220 Volt)] only for clogging indicators
 LED 2 light emitting diodes up to 24 Volt] type "D"
 PSxx dipstick for RFM 75, 165, 185, 195 on request
 PZxx dipstick for RFM 90, 150 on request
 T with tank breather filter
 V FPM seals
 Vxxx with extension tube (where xxx is the final dimension of the extension – no extension for RFM 90, 150!)
 W suitable for HFA und HFC emulsions

2.2 REPLACEMENT ELEMENT

0165 R 010 ON /-V
Size

0075, 0090, 0150, 0165, 0185, 0195, 0210, 0270, 0330, 0500, 0660, 0850, 0950, 1300, 2600

Type

R

Filtration rating in µm

 ON: 001, 003, 005, 010, 015, 020 ECON2: 003, 005, 010, 020 W/HC: 025, 050, 100, 200
 P/HC: 010, 020 MM: 010, 015

Filter material

ON, ECON2, P/HC, W/HC, MM

Supplementary details

V (for descriptions, see point 2.1)

2.3 REPLACEMENT CLOGGING INDICATOR

VMF 2 D . X /-L24
Type

VMF connection thread G 1/8

Pressure setting

2 standard 2 bar, others on request

Type of clogging indicator

see Point 2.1

Modification number

X the latest version is always supplied

Supplementary details

 V only for types B, BM, LE, LZ and C /-EX2G (all other clogging indicators have FPM seals as standard)
 L..., LED (for descriptions, see point 2.1)

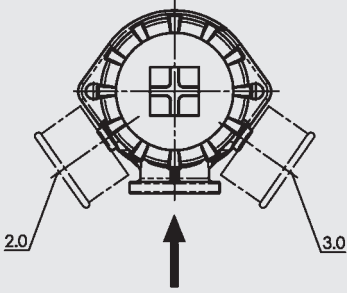
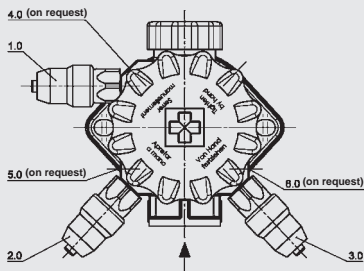
2.4 TYPE CODE: MOUNTING POSITION OF THE CLOGGING INDICATOR
RFM 90, 150

RFM 75, 165, 185, 195

NOTE
Other type codes on request.

Type code	Mounting position of the clogging indicator	Type of indicator
2.X	Clogging indicator on left front, 45° to the inlet	VMF...
3.X	Clogging indicator on right front, 45° to the inlet	VMF...

Type code	Mounting position of the clogging indicator	Type of indicator
1.X	Clogging indicator on left back, 90° to the inlet	VMF...
2.X	Clogging indicator on left front, 45° to the inlet	VMF...
3.X	Clogging indicator on right front, 45° to the inlet	VMF...

2.5 MODEL CODE: IN-TANK MOUNTING FILTER
KIT VERSION

RFM ON 165 KIT 10 W 1.0 /-V
Size

75, 90, 150, 165, 185, 195, 210, 270, 330, 500, 661, 851

In-tank mounting version

KIT bowl only with element and seal

Supplementary details

 B. bypass cracking pressure (e.g. B6 = 6 bar)
 DFxxx spring (where xxx is the relevant length) - on request
 G threaded connection in outlet (RFM 330 to 851)
 V FPM seal
 Vxxx extension tube (where xxx is the final dimension of the extension)

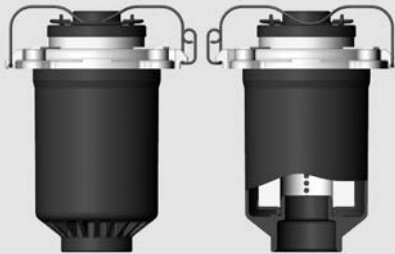
**SET VERSION, screw-on
 Sizes 330 and 500**

RFM ON 330 SET 10 W 1.0 /-V
Size

330, 500

In-tank mounting version

SET bowl only with element and seal, plus adapter ring

Supplementary details

 B. bypass cracking pressure (e.g. B6 = 6 bar)
 G threaded connection in outlet
 V FPM seal
 Vxxx extension tube (where xxx is the final dimension of the extension)

**SET VERSION, screw-on
 Sizes 950 to 2600**

RFM ON 950 SET 10 W 1.0 /-SO441
Filter material (only for this version)

 ECO/N Ecomicon® (ECON2)
 ON Optimicon®

Size

950, 1300, 2600

In-tank mounting version

 SET element only with integral contamination retainer,
 element location spigot and spring

Supplementary details

 SO441 this code must be specified!
 (also required for replacement element)
 V FPM seal

S VERSION, weld-in version

RFM ON 165 S 10 W 1.0 /-V
Size

75, 165, 185

In-tank mounting version

 S bowl only with element, spring and seal,
 plus weld-in housing

Supplementary details

 B. bypass cracking pressure (e.g. B6 = 6 bar)
 V FPM seal
 Vxxx extension tube (where xxx is the final dimension of the extension)

Note:

- Other supplementary details on request (or point 2.1)
- For replacement elements for in-tank filters, see point 2.2

3. FILTER CALCULATION / SIZING

The total pressure drop of a filter at a certain flow rate Q is the sum of the housing Δp and the element Δp and is calculated as follows:

$$\Delta p_{\text{total}} = \Delta p_{\text{housing}} + \Delta p_{\text{element}}$$

$\Delta p_{\text{housing}}$ = see graphs (point 3.1)

$$\Delta p_{\text{element}} = Q \cdot \frac{SK^*}{1000} \cdot \frac{\text{viscosity}}{30}$$

(*see point 3.2)

For ease of calculation, our Filter Configuration Program is available on request free of charge.

NEW: Sizing online at www.hydac.com

3.1 Δp -Q HOUSING CURVES BASED ON ISO 3968

The housing curves apply to mineral oil with a density of 0.86 kg/dm³ and a kinematic viscosity of 30 mm²/s. In this case, the differential pressure changes proportionally to the density.

RFM 90, 150

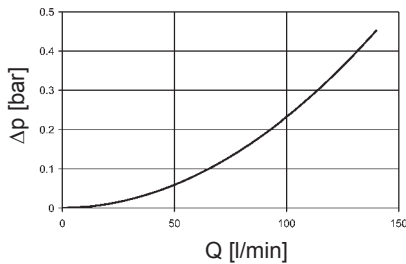

RFM 75, 165, 185

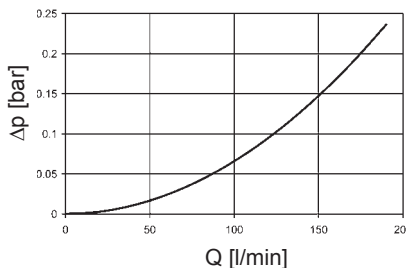

RFM 195

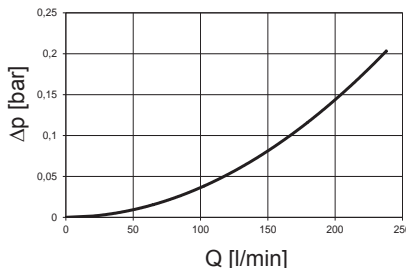

3.2 GRADIENT COEFFICIENTS (SK) FOR FILTER ELEMENTS

The gradient coefficients in mbar/(l/min) apply to mineral oils with a kinematic viscosity of 30 mm²/s. The pressure drop changes proportionally to the change in viscosity.

RFM	ON					
	1 μm	3 μm	5 μm	10 μm	15 μm	20 μm
75	25.6	19.4	13.4	7.31	4.80	4.40
90	22.5	13.1	9.49	6.07	4.30	3.21
150	13.4	7.80	5.65	3.61	2.55	1.91
165	14.1	9.44	7.37	4.02	2.25	2.42
185	10.4	7.44	5.74	2.93	1.65	1.41
195	7.66	5.48	4.22	2.16	1.22	1.04
210	5.66	3.28	2.55	1.53	1.00	0.88
270	3.66	2.12	1.65	0.99	0.65	0.57
330	8.09	3.72	2.73	1.48	1.28	1.02
500	5.27	2.60	1.90	1.09	0.84	0.69
600	2.35	1.23	1.10	0.61	0.42	0.34
660	3.57	1.69	1.21	0.67	0.57	0.45
850	2.77	1.31	1.00	0.58	0.44	0.36
950	2.39	1.03	0.79	0.48	0.38	0.31
1300	1.72	0.72	0.59	0.35	0.32	0.22
2600	0.84	0.36	0.29	0.18	0.16	0.11

RFM	ECON2				W/HC
	3 μm	5 μm	10 μm	20 μm	-
75	22.0	14.2	8.1	4.4	0.362
90	14.9	10.1	6.7	3.2	0.312
150	8.9	6.0	4.0	1.9	0.185
165	11.2	7.8	4.5	2.4	0.199
185	8.9	6.1	3.3	1.8	0.907
195	6.6	4.5	2.4	1.3	0.668
210	-	-	-	-	0.068
270	-	-	-	-	0.044
330	4.2	2.7	1.7	1.2	0.195
500	3.0	1.9	1.3	0.8	0.128
600	-	-	-	-	-
660	1.9	1.2	0.8	0.5	0.067
850	1.5	1.0	0.7	0.4	0.052
950	1.2	0.8	0.5	0.4	0.048
1300	0.8	0.6	0.4	0.3	0.034
2600	0.4	0.3	0.2	0.1	0.017

4. DIMENSIONS

Tank requirements

1. In the filter contact area, the tank flange should have a maximum flatness of 0.3 mm and Ra 3.2 µm maximum roughness.
2. In addition, the contact area should be free of damage and scratches.
3. The fixing holes of the tank flange must be blind, or stud bolts with threadlocker must be used to fix the filter. As an alternative, the tank flange can be continuously welded from the inside.
4. Both the tank sheet metal and/or the filter mounting flange must be sufficiently robust so that neither deform when the seal is compressed during tightening.
5. When using a dipstick through a mounting screw, threadlock the screw into the thread, using Loctite 243, for example, or a similar threadlocker.

RFM 75, 165, 185, 195

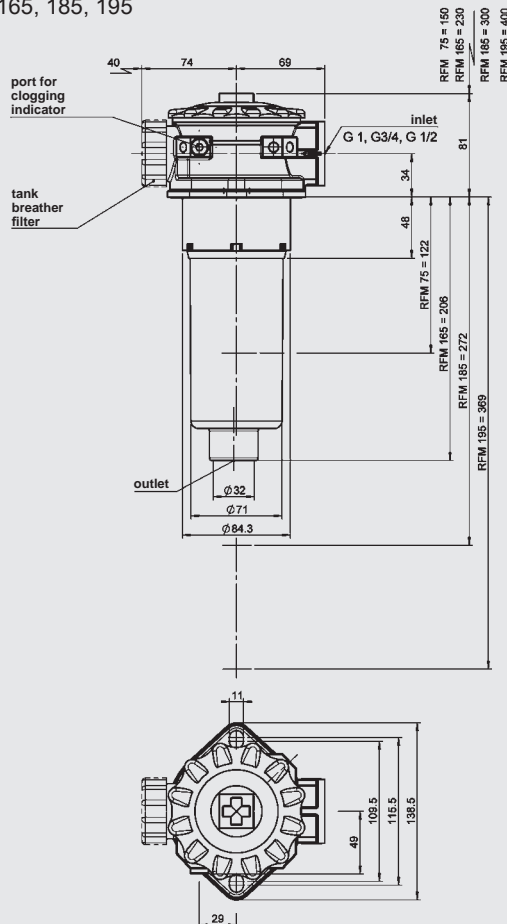

RFM	Weight incl. element [kg]	Vol. of pressure chamber [l]
75	0.90	0.60
90	0.54	0.60
150	0.75	0.80
165	1.10	0.90
185	1.14	1.10
195	1.30	1.60

RFM 90, 150

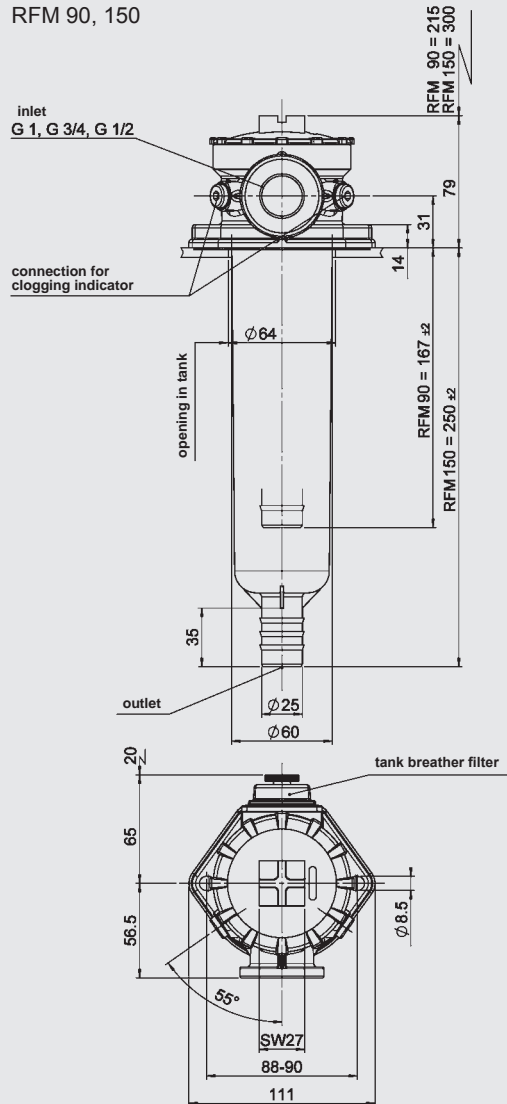

NOTE

The information in this brochure relates to the operating conditions and applications described.
For applications or operating conditions not described, please contact the relevant technical department.
Subject to technical modifications.

HYDAC Filtrertechnik GmbH
Industriegebiet
D-66280 Sulzbach/Saar
Tel.: 0 68 97 / 509-01
Fax: 0 68 97 / 509-300
Internet: www.hydac.com
E-Mail: filter@hydac.com