

Niehues Systems engineering

Series units



„Niehues - a team for our
Customers, employees and suppliers.“

Good reasons

"We make ourselves strong for our customers!" This principle shows the motivation and commitment with which we work for our partners.

Your tasks will be discussed with you on site if desired. If required, we will also be happy to invite you to our premises in Senden / Westphalia to take the opportunity to present our company and its capabilities to you in person.



Series units

The purpose of our series units is to supply pressure oil and control a very wide variety of types of hydraulic systems with small to medium feed volume. The series units can be employed for many uses.

Benefits

The series units stand out for quick delivery times, good spare parts procurement, and good price-performance relationship.

Equipment

All standard units are equipped with a back-pressure filter incl. ventilation filter. The tanks are made of aluminum, which results in good heat loss performance due to high thermal conductivity. The tank cover is made of steel and painted. Gear pumps are used for the series units.

Duty cycle

The heating of the oil depends on many factors such as oil filling, oil consumption, ambient temperature and required drive power. For this reason, it is not possible to give a precise indication of the duty cycle. The max. permissible oil temperature is 70°C.

Additional equipment

With the extensive accessories the aggregates can be adapted to your individual application. For this purpose, various components are available, such as pressure relief valve, valve functions, pressure switch, temperature or level switch, oil cooler etc.

Valves

The electrically switching valves are equipped with 24V= solenoid coils.



If you do not find what you are looking for here or if you have any questions about the product, our technical department will be happy to help you and work with you to design your desired unit.

Here you can find our **contact persons**

Order code

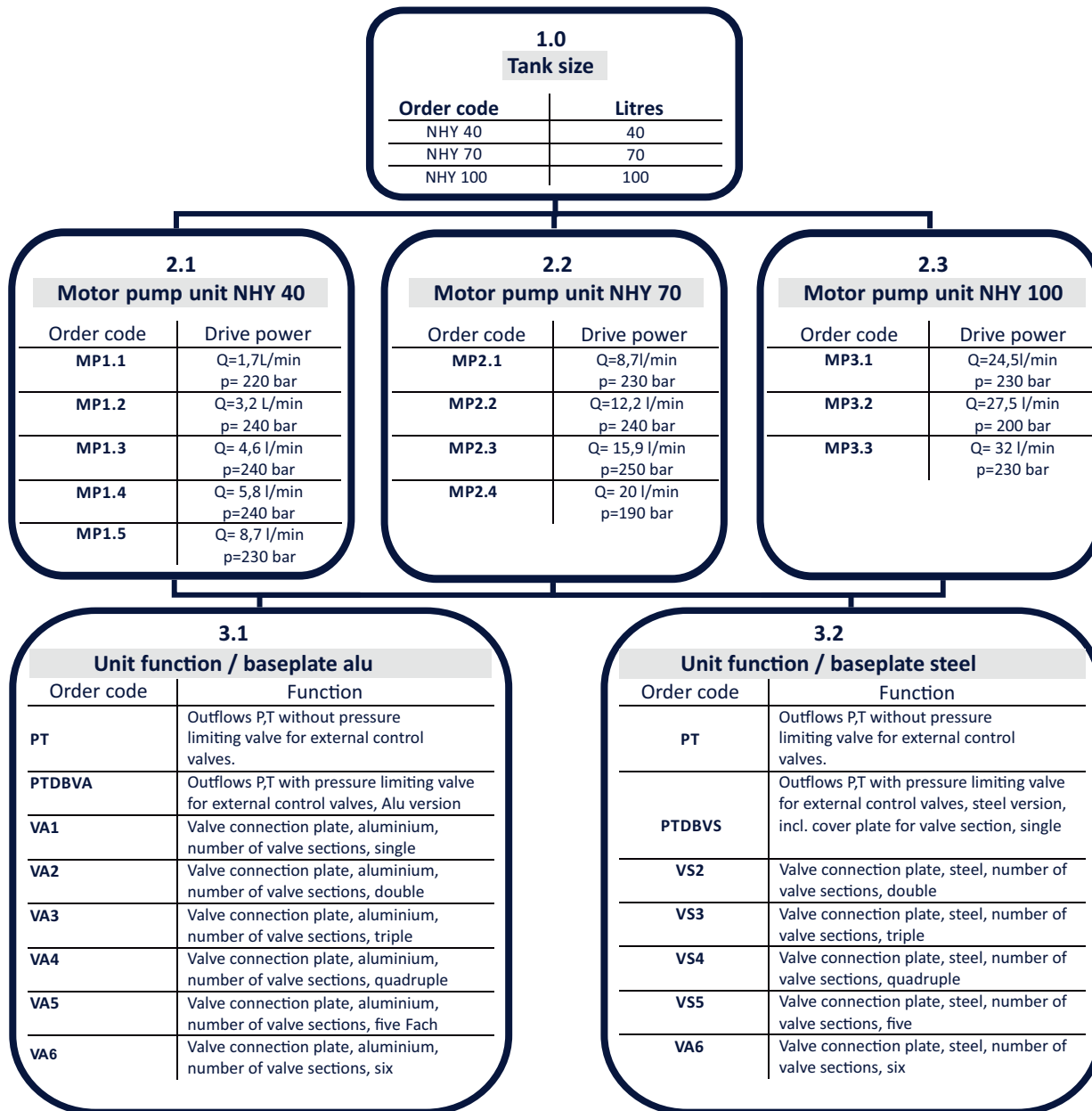

Explanation of order code

1. Choice of tank size:

There are 3 different tank sizes to choose from: 40 litres (NHY 40), 70 litres (NHY 70) and 100 litres (NHY 100).

The max. available feed volume of the motor pump unit depends on the chosen tank size (see Selection Table 1 and 2).

2. Choice of motor pump units:

There are various motor pump units to choose from, ranging from 1.7 l/min to 32 l/min. The available feed volumes according to tank size can be taken from the corresponding table.

Tank size NHY 40 Table 2.1

Tank size NHY 70 Table 2.2

Tank size NHY 100 Table 2.3

3. Choice of unit functions / baseplates

There are various unit function versions to choose from (outflows P+T, with/without pressure limiting valve), as well as baseplate versions with vertical stacked systems with 1 to 6 connections. Additionally, the baseplate material can be selected, depending on usage, from either aluminium (Table 3.1) for standard functions, or steel (Table 3.2) for highly dynamic functions.











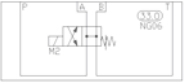

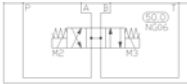

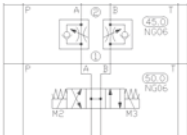

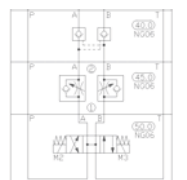
Electric drive power		
Motor pump unit	Order code	Electrical power / network voltage
NHY 40	MP1.1	0,75 kW 400V/50Hz
NHY 40	MP1.2	1,5 kW 400V/50Hz
NHY 40	MP1.3	2,2 kW 400V/50Hz
NHY 40	MP1.4	3,0 kW 400V/50Hz
NHY 40	MP1.5	4,0 kW 400V/50Hz
NHY 70	MP2.1	4,0 kW 400V/50Hz
NHY 70	MP2.2	5,5 kW 400V/50Hz
NHY 70	MP2.3	7,5 kW 400V/50Hz
NHY 70	MP2.4	7,5 kW 400V/50Hz
NHY 100	MP3.1	11,0 kW 400V/50Hz
NHY 100	MP3.2	11,0 kW 400V/50Hz
NHY 100	MP3.3	15,0 kW 400V/50Hz

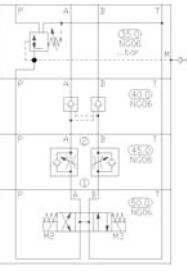
4. Choice of optional equipment:

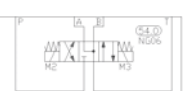
A wide array of optional equipment for the units is available, so that you can extend the units as you wish. Please state your requirements as full text with the order. (See Selection Table 4.0)

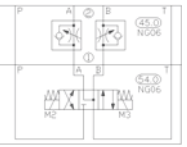

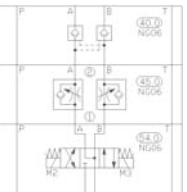







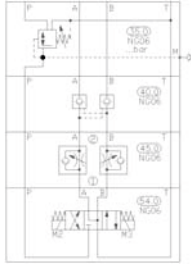

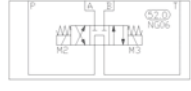

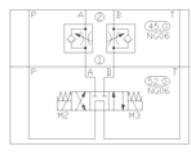
Optional equipment

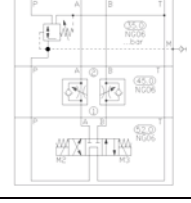
Optional equipment 4.0

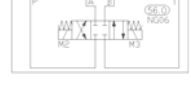

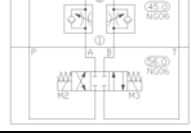

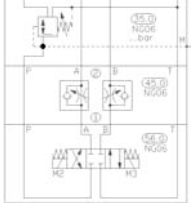









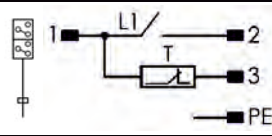

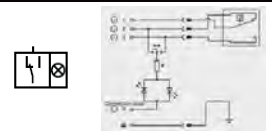

Order code	Func on	Circuit diagram	Image	Technical product data
Valve control V-H1 81000648	4/2-directional control valve H-slide			NG06, Cetop 03 max. operating pressure: P, A, B: 350 bar; T: 210 bar Basic position: A-B-P-T connected Seal: NBR Voltage: 24V=
Valve control V-H 81000649	4/3-directional control valve H-slide			NG06, Cetop 03 max. operating pressure: P, A, B: 350 bar; T: 210 bar Basic position: A-B-P-T connected Seal: NBR Voltage: 24V=
Valve control V-H/DR 81000650	4/3-directional control valve H-slide Throttle-type non-return valve			NG06, Cetop 03 max. operating pressure: P, A, B: 350 bar; T: 210 bar Basic position: A-B-P-T connected Seal: NBR Voltage: 24V=
Valve control V-H/DR/SP 81000651	4/3-directional control valve H-slide Throttle-type non-return valve hydr. opening Non-return valve			NG06, Cetop 03 max. operating pressure: P, A, B: 350 bar; T: 210 bar Basic position: A-B-P-T connected Seal: NBR Voltage: 24V=
Valve control V-H/DR/SP/DM 81000652	4/3-directional control valve H-slide Throttle-type non-return valve hydr. opening Non-return valve Pressure reducing valve			NG06, Cetop 03 max. operating pressure: P, A, B: 350 bar; T: 210 bar Basic position: A-B-P-T connected Seal: NBR Voltage: 24V= Pressure reduction in P line, adjustment range to max. 210 bar
Valve control V-J 81000653	4/3-directional control valve J-slide			NG06, Cetop 03 max. operating pressure: P, A, B: 350 bar; T: 210 bar Basic position: A-B-T connected / P closed Seal: NBR Voltage: 24V=
Valve control V-J/DR 81000654	4/3-directional control valve J-slide Throttle-type non-return valve			NG06, Cetop 03 max. operating pressure: P, A, B: 350 bar; T: 210 bar Basic position: A-B-T connected / P closed Seal: NBR Voltage: 24V=
Valve control V-J/DR/SP 81000655	4/3-directional control valve J-slide Throttle-type non-return valve hydr. opening Non-return valve			NG06, Cetop 03 max. operating pressure: P, A, B: 350 bar; T: 210 bar Basic position: A-B-T connected / P closed Seal: NBR Voltage: 24V=

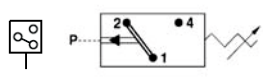
Optional equipment

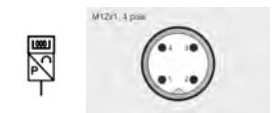
Optional equipment 4.0

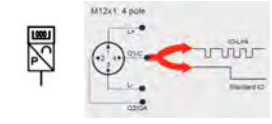
Order code	Func on	Circuit diagram	Image	Technical product data
Valve control V-J/DR/SP/DM 81000656	4/3-directional control valve J-slide Throttle-type non-return valve hydr. opening Non-return valve Pressure reducing valve			NG06, Cetop 03 max. operating pressure: P, A, B: 350 bar; T: 210 bar Basic position: A-B-T connected / P closed Seal: NBR Voltage: 24V= Pressure reduction in P line, adjustment range to max. 210 bar
Valve control V-G 81000657	4/3-directional control valve G-slide			NG06, Cetop 03 max. operating pressure: P, A, B: 350 bar; T: 210 bar Basic position: A-B closed / P-T connected Seal: NBR Voltage: 24V=
Valve control V-G/DR 81000658	4/3-directional control valve G-slide Throttle-type non-return valve			NG06, Cetop 03 max. operating pressure: P, A, B: 350 bar; T: 210 bar Basic position: A-B closed / P-T connected Seal: NBR Voltage: 24V=
Valve control V-G/DR/DM 81000659	4/3-directional control valve G-slide Throttle-type non-return valve Pressure reducing valve			NG06, Cetop 03 max. operating pressure: P, A, B: 350 bar; T: 210 bar Basic position: A-B closed / P-T connected Seal: NBR Voltage: 24V= Pressure reduction in P line, adjustment range to max. 210 bar
Valve control V-E 81000660	4/3-directional control valve E-slide			NG06, Cetop 03 max. operating pressure: P, A, B: 350 bar; T: 210 bar Basic position: A-B-P-T closed Seal: NBR Voltage: 24V=
Valve control V-E/DR 81000661	4/3-directional control valve E-slide Throttle-type non-return valve			NG06, Cetop 03 max. operating pressure: P, A, B: 350 bar; T: 210 bar Basic position: A-B-P-T closed Seal: NBR Voltage: 24V=
Valve control V-E/DR/DM 81000662	4/3-directional control valve E-slide Throttle-type non-return valve Pressure reducing valve			NG06, Cetop 03 max. operating pressure: P, A, B: 350 bar; T: 210 bar Basic position: A-B-P-T closed Seal: NBR Voltage: 24V= Pressure reduction in P line, adjustment range to max. 210 bar

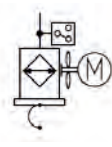
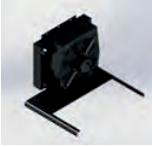
Accessories

Accessories			
Order code	Circuit diagram	Image	Technical product data
Pressure gauge GLY 49000891			Nominal size: 63 Display 0-400 bar Connection, mechanical: G1/4" male
Oil pan W-40 49000892 Oil pan W-70 49000893 Oil pan W100 49000894			Oil pan without feet, Material: steel Volume: 40 litres / 70 litres / 100 litres
Level switch NT-40 49000895 Level switch NT-70 49000896 Level switch NT-100 49000897			Level-temperature switch, 1 switch contact in each case (min. level / max. temperature) Plug and socket connection: 3+PE Operating voltage: 24V / 230V
Fouling indicator (RFM) O 49000830			Optical fouling indicator for return filter, Display pressure 0 to +10 bar
Fouling indicator (RFM) OE 49000841			Optical/electrical fouling indicator for return filter, Response pressure: 2 bar Switch type: Normally closed contact or normally open contact Switch voltage: 24V
Pressure switch DS 49000898			Max. operating pressure = 600 bar Switching point: 25 – 250 bar Elec. connection: Changeover contact Tolerance: +/- 5.0 - 7.0 bar Seal: NBR max. voltage 250 V E connection PG 9 with terminal box IP 65
Pressure switch DA 49000899			Pressure switch with display 2x switch output 1x analogue output 4-20mA Supply voltage: 18...35 V DC Switching point: 0 – 250 bar
Pressure switch DIO 49001998			IO link pressure switch with display, 1x switch output 1x switch or analogue output 4-20mA Supply voltage: 18...35 V DC Switching point: 0 – 250 bar
Oil air cooler OIL-40 49000900 Oil air cooler OIL-70 49000901 Oil air cooler OIL-100 49000902			Cooler OIL-40/-70: Cooling power: approx. 2.5kW at ΔT 20°C (dependant on the volume flow) Motor: 0.17 kW 400V/50Hz Sound level: approx. 71 dB(A) Cooler OIL-100: Cooling power: approx. 4.0 kW at ΔT 20° C (dependant on the volume flow) Motor: 0.19 kW 400V/50Hz Sound level: approx. 75 dB(A)
Socket sheet 2x G1/2" welding socket 81000622			Socket sheet for placement of 2x G1/2" reserve connections Material: steel

Pin	EDS 34X6-1	EDS 34X6-2	EDS 34X6-3
1	+U _S	+U _S	+U _S
2	n.c.	SP2	Analogue
3	0 V	0 V	0 V
4	SP1	SP1	SP1

Pin	Signal	Description
1	L+	+U _S
2	Q2/QA	Switching output (SP2) / analogue output
3	L-	0 V
4	Q1/C	IO-Link communication / switching output (SP1)

Hydraulic circuit diagram

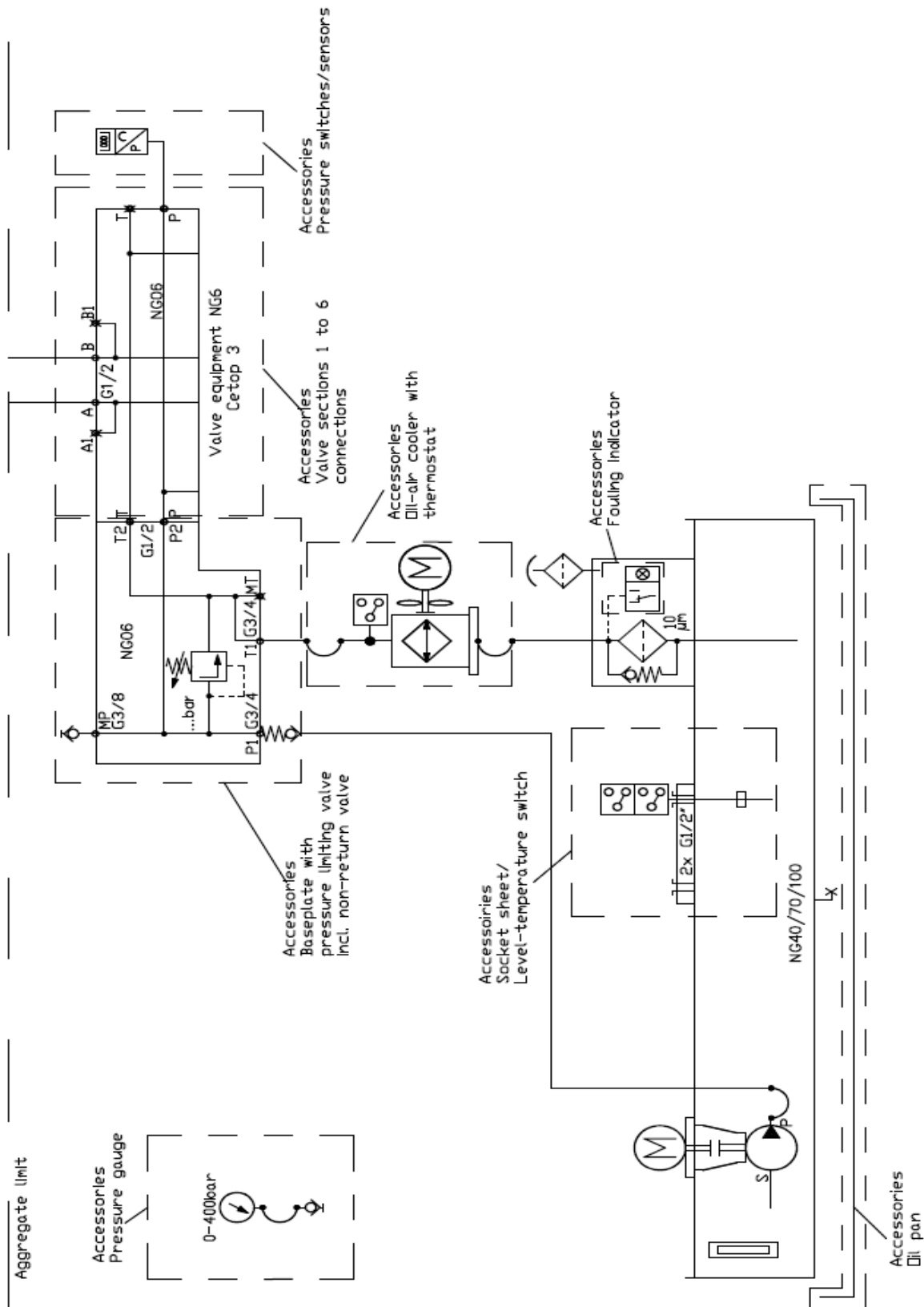

Overview drawing NHY-40

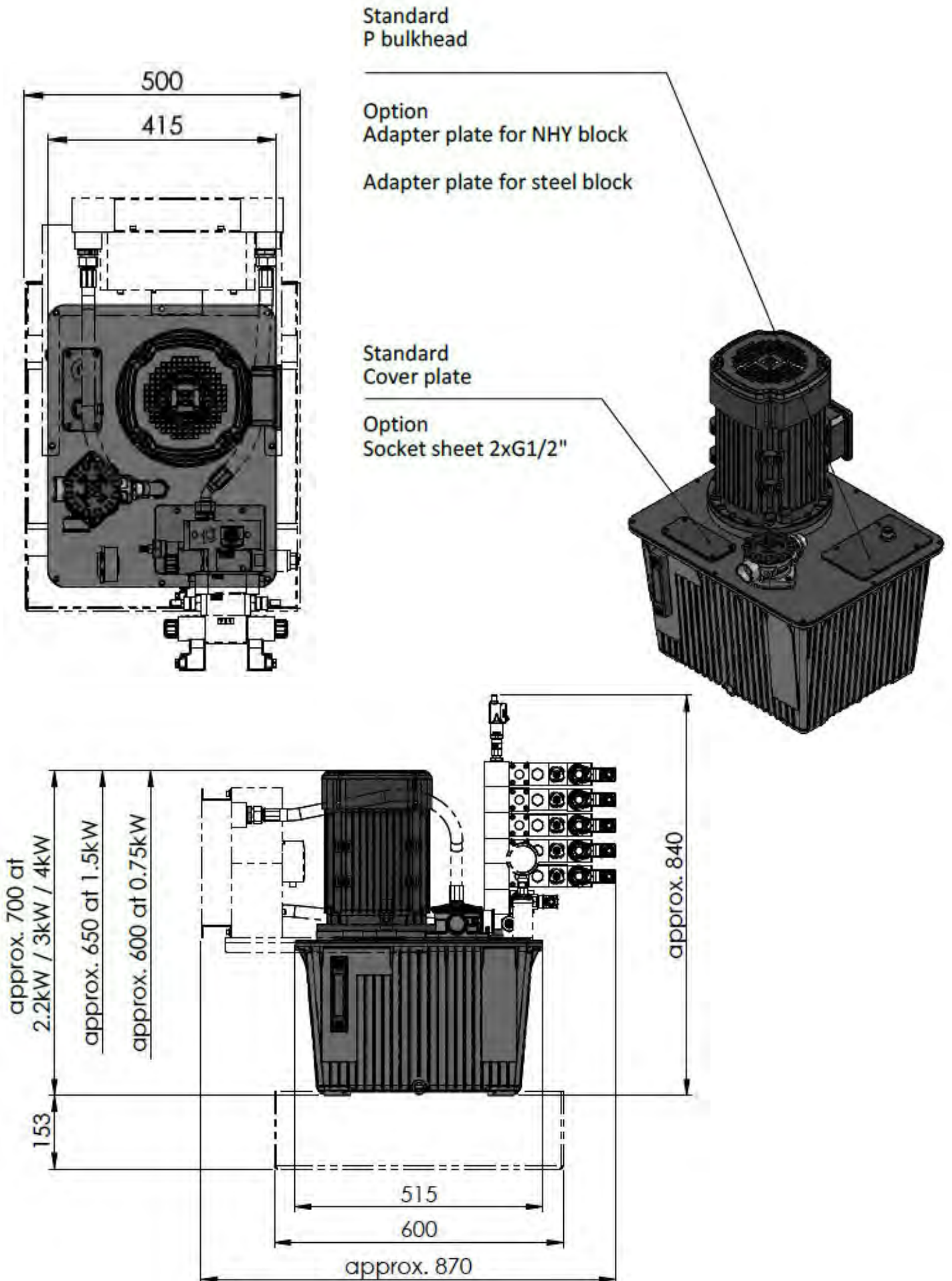

Overview drawing NHY-70

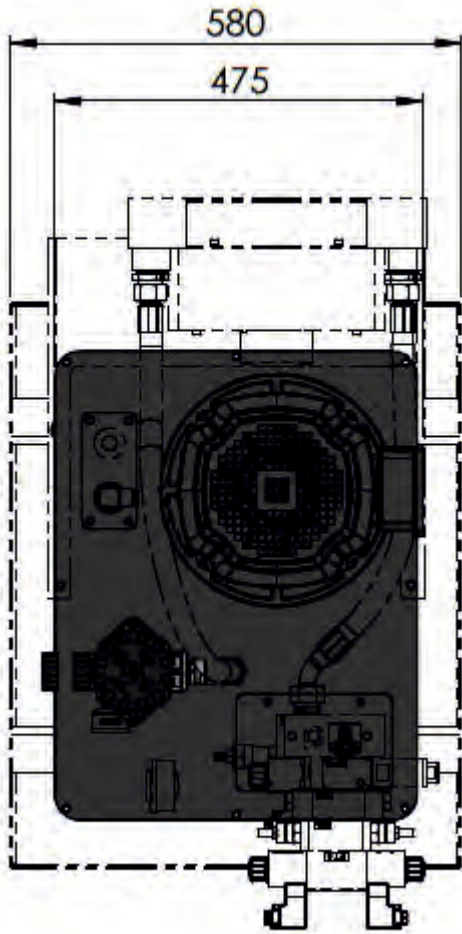

Standard
P bulkhead

Option
Adapter plate for NHY block

Adapter plate for steel block

Standard
Cover plate

Option
Socket sheet 2xG1/2"

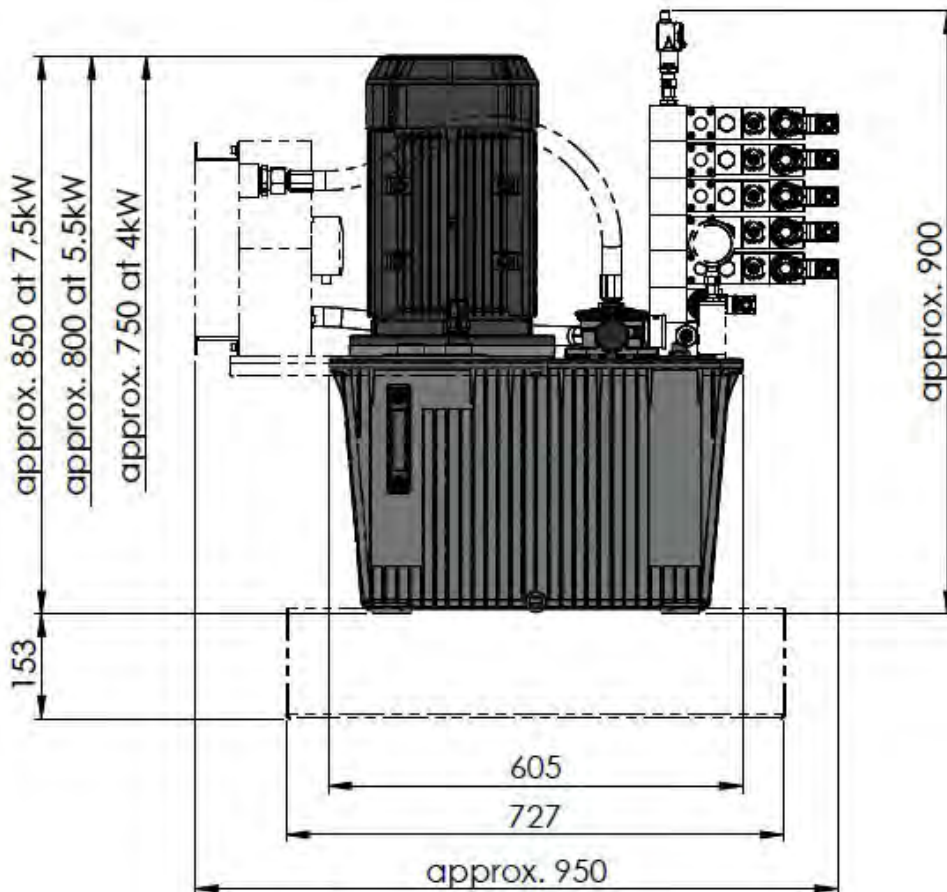
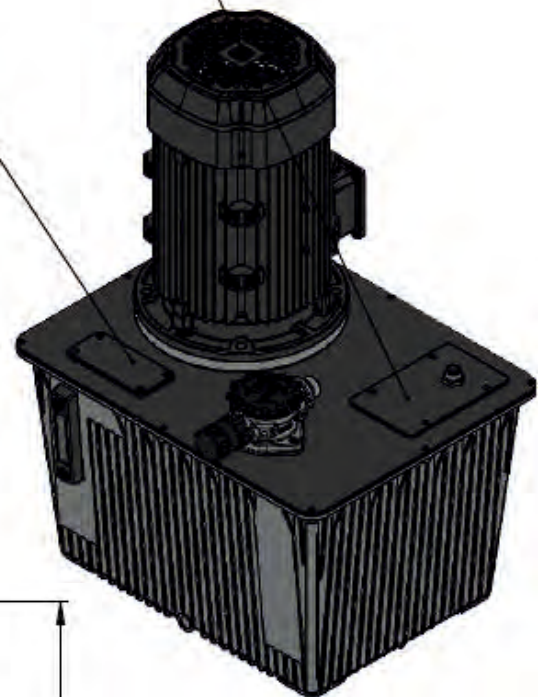

Overview drawing NHY-100

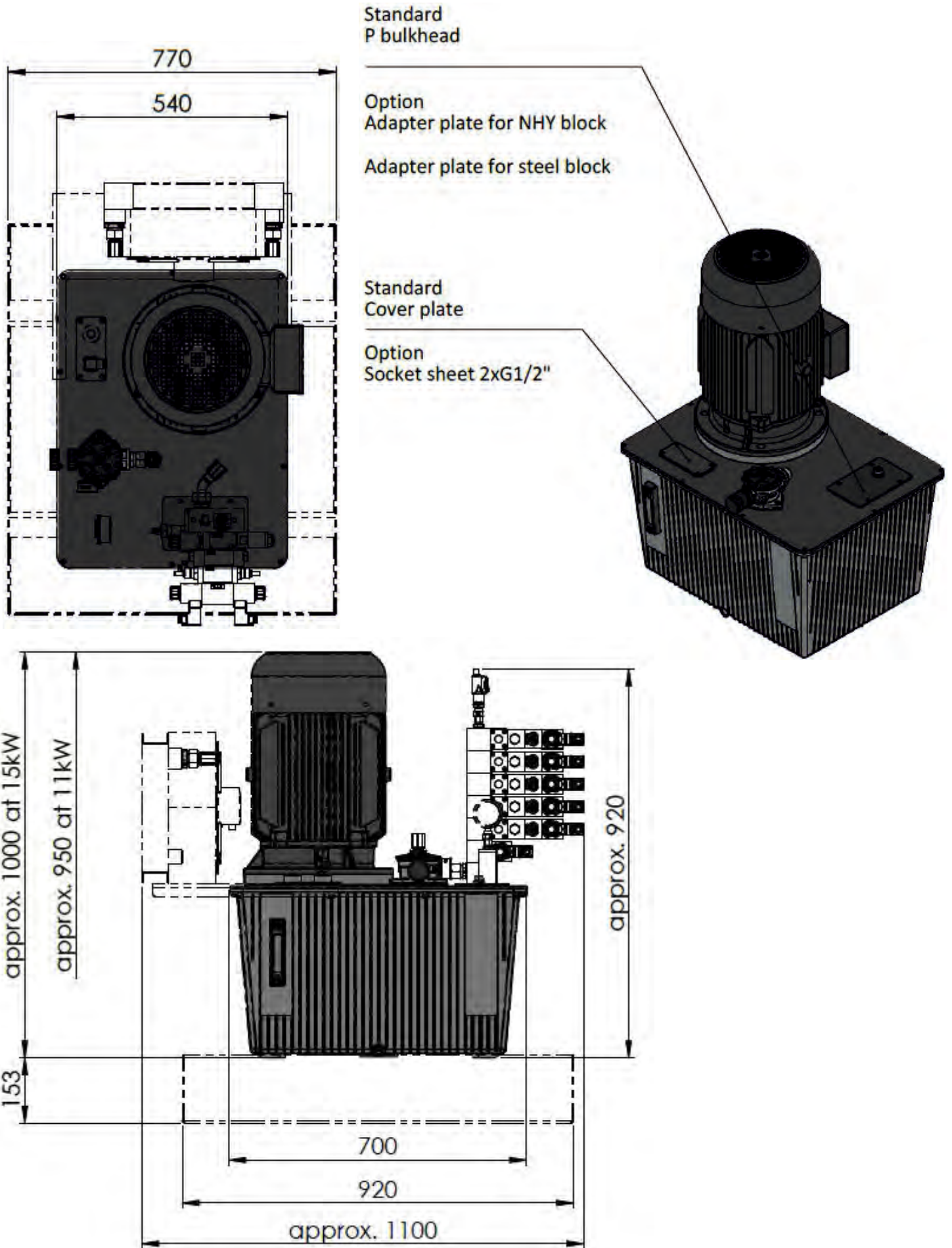

Overview Accessories Options

Accessories

Oil-air cooler

Accessories

Level and temperature switch

Accessories

Oil pan

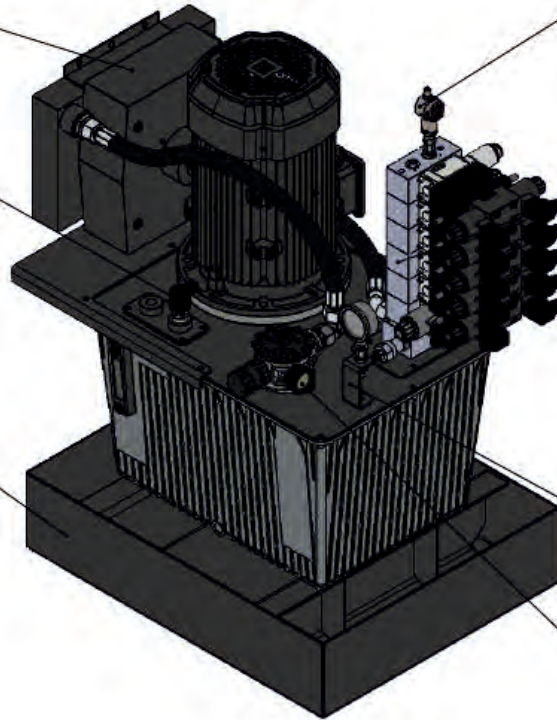

Optional accessories

Pressure switch
analogue output or
two switching points

Accessories

Valve control

Accessories

Pressure gauge

Optional accessories

Fouling indicator
optical or optical-electric

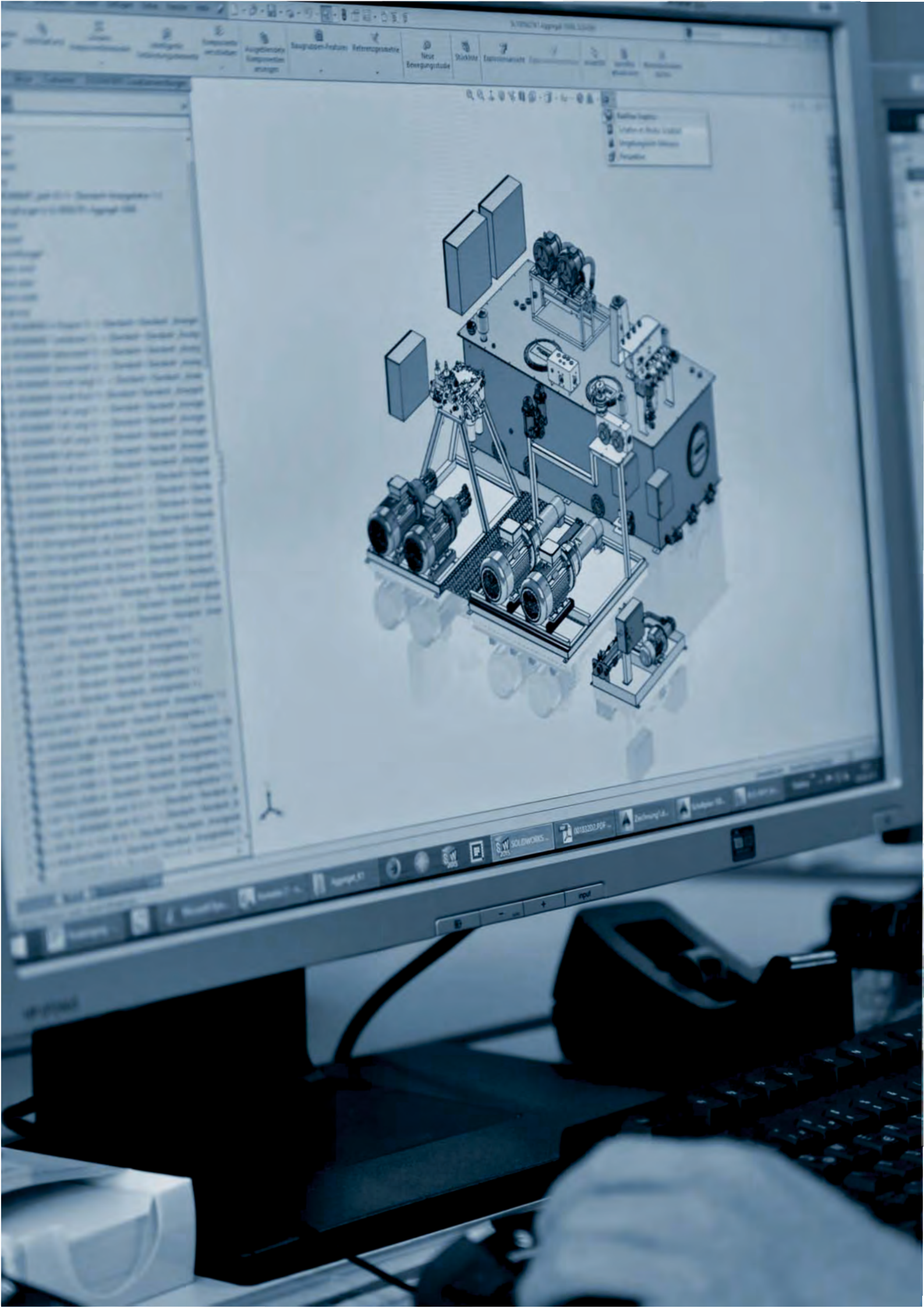



Th. Niehues GmbH

Bahnhofstraße 81
48308 Senden / Wes.
Phone: +49 2536 990 -01

E-Mail: info@niehues.com

Internet: www.niehues.com | www.niehues.shop