













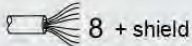

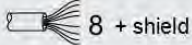

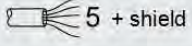

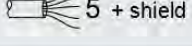

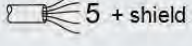

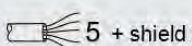



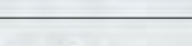

HYDAC INTERNATIONAL
**Electrical
Accessories**
Connector, female

				Part No.
5		Female connector with screw terminal, 5-pole, M12x1, to DIN VDE 0627	–	6049128
5		Female connector with screw terminal, shielding, 5-pole, M12x1, to DIN VDE 0627	ZBE 08	6006786
8		Female connector with screw terminal, 8-pole, M12x1, to DIN VDE 0627	ZBE 44	3281243
8		Female connector with screw terminal, 8-pole, M12x1, to DIN VDE 0627	ZBE 0P	6055444





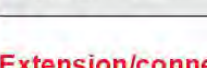



Connection cable, shielding

Connector, female	↔	Cable end open	Length		Part No.
8		↔  8 + shield	2 m	ZBE 42S-02	3281220
8		↔  8 + shield	5 m	ZBE 42S-05	3281239
5		↔  5 + shield	5 m	ZBE 47S-05	3527626
5		↔  5 + shield	10 m	ZBE 47S-10	3527627
5		↔  5 + shield	2 m	ZBE 08S-02	6019455
5		↔  5 + shield	5 m	ZBE 08S-05	6019456
5		↔  5 + shield	10 m	ZBE 08S-10	6023102
5		↔  5 + shield	30 m	ZBE 08S-30	6035063



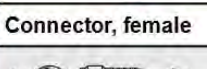
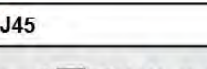

Connection cables

Connector, female	↔	Cable end open	Length	Part No.
	↔	 8	2 m ZBE 0P-02	6052697
	↔	 5	2 m ZBE 08-02	6006792
	↔	 5	5 m ZBE 08-05	6006791
	↔	 5	5 m ZBE 47-05	3484562
	↔	 5	10 m ZBE 47-10	3484564

Extension/connection cables

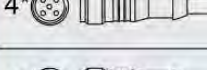
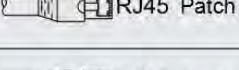
Connector, female	↔	Connector, male	Length	Part No.
	↔	 8	5 m ZBE 43-05	3281240
	↔	 8	10 m ZBE 43-10	3519768
	↔	 5	2 m ZBE 30-02	6040851
	↔	 5	3 m ZBE 30-03	6053924
	↔	 5	5 m ZBE 30-05	6040852

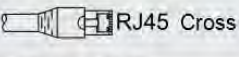

Connecting cables - CS 2000

Connector, female	↔	RJ45	Length	Part No.
	↔	 RJ45 Patch	5 m ZBE 45-05	3346100
	↔	 RJ45 Patch	10 m ZBE 45-10	3346101
	↔	 RJ45 Cross	5 m ZBE 46-05	3346102
	↔	 RJ45 Cross	10 m ZBE 46-10	3346103

* For CS 2000 only ("D"-coded to: IEC 61076-2-101)



Adapter

For: AS 1000 / HYDACLab ↔ HMG

				Part No.	
Connector, female			Connector, male	ZBE 36	909737



Y-Adapters

For AS 1000 / HYDACLab ↔ HMG



				Part No.	
Connector, female			Connector, male	ZBE 26	3304374
			Connector, male		
Colour: blue					

For: HMG 500 / HMG 3000

To double the number of input sockets

				Part No.	
Connector, male			Connector, female	ZBE 38	3224436
			Connector, female		
Colour: black					



For CS 1000 ↔ CSI / HMG





				Part No.	
Connector, female			Connector, male	ZBE 41	910000
			Connector, male		
Colour: yellow					

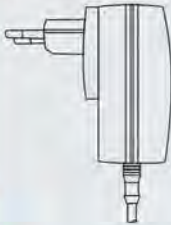

Dust caps

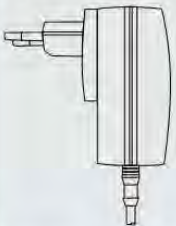
			Part No.
	Male M12 - nickel-plated		6079195

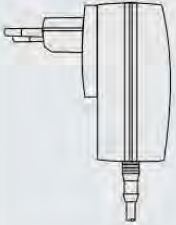
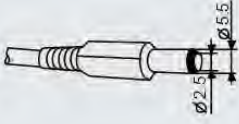
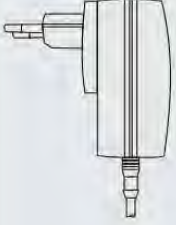
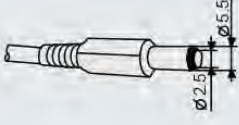

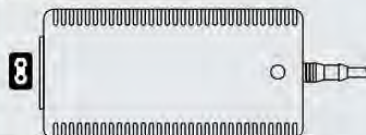
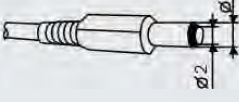

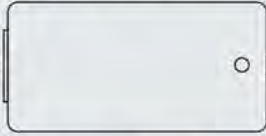

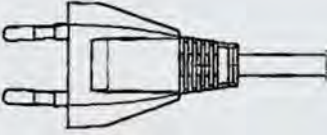

Power supply

Power supply	↔	Connector, female	Length	Part No.
100 – 240 V AC, 50-60 Hz, 0.4 A		15 V DC, 500 mA		
	↔		1.8 m PS1	3376530
Protection class: IP40 Example: CS 1000				

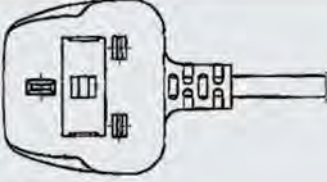

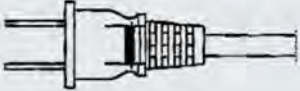

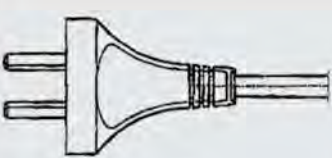
<p>100 – 240 V AC, 50-60 Hz, 1,1 A</p>  <p>Protection class: IP40 Example: SMU 1000 series</p>	<p>24 V DC, 1000 mA</p> <p>↔</p>  <p>5 1.8 m PS5</p>	<p>3399939</p>
<p>100 – 240 V AC, 50-60 Hz, 0,5 A</p>  <p>Protection class: IP40 Example: CSI-D-5</p>	<p>12 V DC, 550 mA</p> <p>↔</p>  <p>1.8 m PS2</p>	<p>6076711</p>
<p>100 – 240 V AC, 50-60 Hz, 2 A</p>  <p>Protection class: IP40 Example: FAS</p>	<p>12 V DC, 2000 mA</p> <p>↔</p>  <p>1.8 m PS7</p>	<p>6099121</p>
<p>100 – 240 V AC, 50-60 Hz, 2 A</p>  <p>Without connecting cable Protection class: IP40 Example: FCU 1000 / MBS 1000</p>	<p>24 V DC, 5000 mA</p> <p>↔</p>  <p>1.8 m PS3</p>	<p>6059933</p>
<p>100 – 240 V AC, 50-60 Hz, 1,1 A</p>  <p>Without connecting cable Protection class: IP40 Example: FCU 2000-x</p>	<p>24 V DC, 2200 mA</p> <p>↔</p>  <p>1.8 m PS4</p>	<p>3090803</p>

90 – 240 V AC, 47-63 Hz	12 V DC, 6600 mA	
		1.6 m PS6 6066586
Without connecting cable Protection class: IP40 Example: FCU 1000, Field Verification Kit		

Connecting cable for power supply (PS3 / PS4)

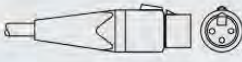
Mains plug, male	↔	Connector, female	Length	Part No.
	↔		2 m –	6008448
Europe – EN50075				
	↔		2 m –	6008447
United Kingdom				
	↔		2 m –	6008446
USA				
	↔		2 m –	6008449
Australia – A.S. 3112				

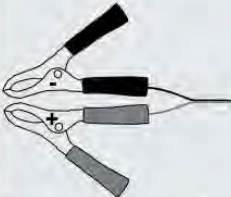
Power supply cable

Connector, male	↔	Connector, female	Length	Part No.
max. 24 V DC  Example: FCU 1000	↔		10 m -	3306236
max. 24 V DC  Example: FCU 1000	↔		1 m -	3524138
Battery clamps	↔	Connector, female	Length	Part No.
max. 24 V DC  Example: FCU 1000	↔	24 V DC 	0.35 m -	6051653

Parallel extension/connection cable

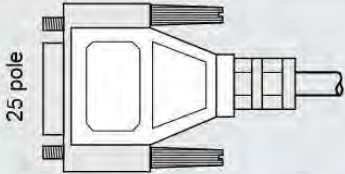
Connector, male	↔	Connector, female	Length	Part No.
 25 pole Example: FCU 2000 -> external printer	↔	CENTRONICS interface	3 m -	349157

Serial extension/connection cable

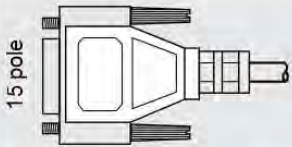
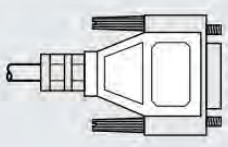
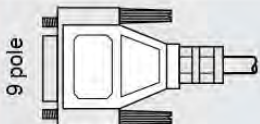
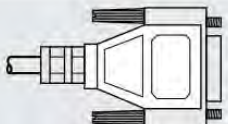
Connector, female	↔	Connector, female	Length	Part No.
 15 pole Example: FCU 2000 -> PC	↔	 9 pole	2 m -	349204
Connector, female	↔	Connector, male	Length	Part No.
 9 pole Example: ConditionSensor Interface ↔ Adapter / PC (RS232 cable)	↔	 9 pole	1.8 m -	629269

Extension/connection cable - USB

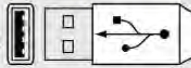
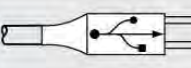
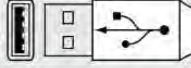
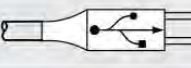
Connector, female	↔	Connector, female	Length	Part No.
A 	↔	 B	1.8 m –	6064126
A 	↔	 B	5 m –	6064127

Bluetooth/USB adapter

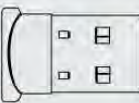
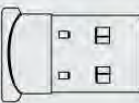
Bluetooth	↔	USB (A)	Part No.
	↔		6074886

Converter

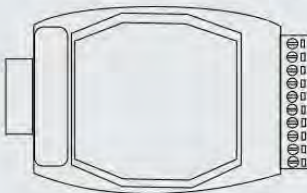
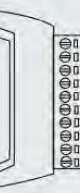
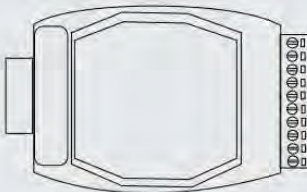
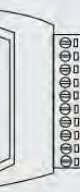
Connector, female	↔	Terminal strip	Part No.
RS 232	↔	RS 485	6013281
	↔		
USB (B)	↔	RS 485	6042337
	↔		

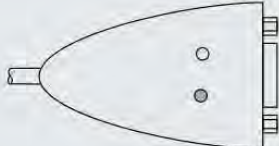
Connector, female	↔	Connector, male	Part No.
USB (A)	↔	RS 232	6048267
	↔		

CSI-B-1

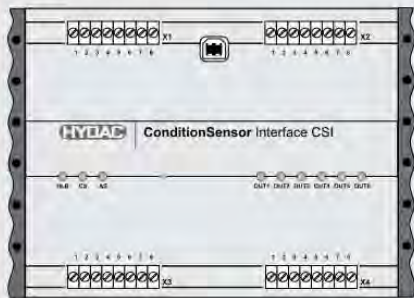

3308212

Protection class: IP40

CSI-B-2 KIT

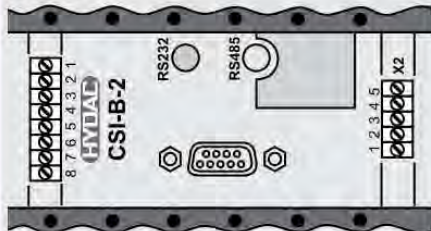

Consisting of:

- CSI-B-2
- Connection cable ZBE08S-05
- Connection cable ZBE42S-05
- RS232 cable
- Y-Adapter ZBE41
- Converter RS232/USB
- CD FluMoS Light

3409462

Protection class CSI-B-2: IP40

CSI-D-5 KIT

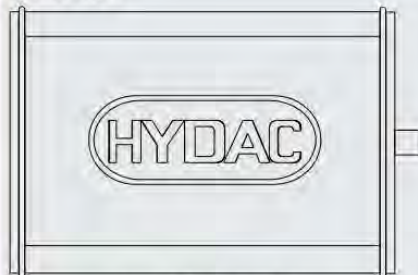

Consisting of:

- CSI-D-5
- Power supply PS2
- USB cable, L=1.8m
- Extension/connection cable ZBE43-05
- CD FluMoS Light

3249563

Protection class CSI-D-5: IP40