

Data Sheet

Solenoid valve Types **EV220B** and **EV220BW**

Types **EV220B 15-50** and **EV220BW 40-50**



EV220B 15-50 and EV220BW 40-50 are a universal indirect servo-operated 2/2-way solenoid valve program. Valve body in brass, dezincification resistant brass and stainless steel ensures that a broad variety of application can be covered. Built-in pilot filter as standard, adjustable closing time and enclosures up to IP67 ensures optimal performance even under critical working conditions.

Features

- For water, steam, oil, compressed air and gases
- Ambient temperature: Up to 80 °C
- Coil enclosure: Up to IP67
- Water hammer damped
- Built in filter for protection of pilot system
- Adjustable closing time available
- EV220B 15-50 NC and NO brass version for neutral liquids and gasses
- EV220B 15-50 NC DZR brass version for neutral and slightly aggressive liquids and gases
- EV220B 15-50 NC Stainless Steel version for neutral and aggressive liquids and gases
- EV220BW 40-50 NC+NO EPDM and WRAS for drinking water





AI236986444669en-001101

Archivierung: 04/2022

Solenoid valve, Types EV220B 15-50 and EV220BW 40-50

1 Portfolio overview

Table 1: Portfolio overview

Features	EV220B 15-50	EV220B 15-50	EV220BW 40-50	EV220B 15-50
				
Body material	Brass	DZR brass	Brass	Stainless steel
DN [mm]	15 - 50	15 - 50	40 - 50	15 - 50
Connection	G1/2 - G2	G1/2 - G2	G11/2 - G2	G1/2 - G2
Sealing material	EPDM/FKM/NBR	EPDM	EPDM	EPDM/FKM
Function	NC/NO	NC	NC/NO	NC
K_v [m³/h]	4 - 40	4 - 40	24 - 40	4 - 40
Differential pressure range [bar]	0.3 - 16	0.3 - 16	0.3 - 10	0.3 - 16
Temperature range [°C]	-30 - 120	-30 - 120	0 - 90	-30 - 120

2 Functions

2.1 Function NC, brass, DZR brass and stainless steel

Coil voltage disconnected (closed)

When the voltage is disconnected, the valve plate (3) is pressed down against the pilot orifice (4) by the armature spring (2). The pressure across the diaphragm (5) is built up via the equalizing orifice (7). The diaphragm closes the main orifice (6) as soon as the pressure across the diaphragm is equivalent to the inlet pressure. The valve will be closed for as long as the voltage to the coil is disconnected.

Coil voltage connected (open)

When voltage is applied to the coil (1), the pilot orifice (4) is opened. As the pilot orifice is larger than the equalizing orifice (7), the pressure across the diaphragm (5) drops and therefore it is lifted clear of the main orifice (6). The valve is now open for unimpeded flow and will be open for as long as the minimum differential pressure across the valve is maintained, and for as long as there is voltage to the coil.

Figure 1: Function, NC

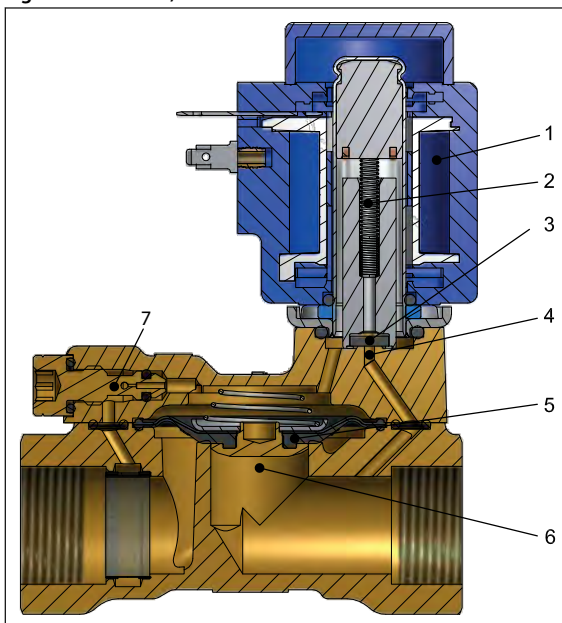

- | | |
|----|--------------------|
| 1. | Coil |
| 2. | Armature spring |
| 3. | Valve plate |
| 4. | Pilot orifice |
| 5. | Diaphragm |
| 6. | Main orifice |
| 7. | Equalizing orifice |

2.2 Function NO, brass

Coil voltage disconnected (open)

When the voltage to the coil (2) is disconnected, the pilot orifice (4) is open. As the pilot orifice is larger than the equalizing orifice (7), the pressure across the diaphragm (5) drops and therefore it is lifted clear of the main orifice (6). The valve will be open for as long as the minimum differential pressure across the valve is maintained, and for as long as the voltage to the coil is disconnected.

Coil voltage connected (closed)

When voltage is applied to the coil, the valve plate (3) is pressed down against the pilot orifice (4). The pressure across the diaphragm (5) is built up via the equalizing orifice (7). The diaphragm closes the main orifice (6) as soon as the pressure across the diaphragm is equivalent to the inlet pressure. The valve will be closed for as long as there is voltage to the coil.

Solenoid valve, Types EV220B 15-50 and EV220BW 40-50

Figure 2: Function, NO

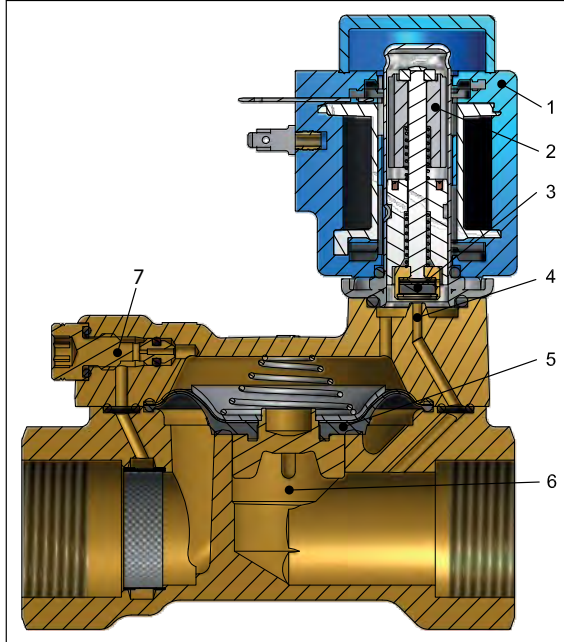

- | | |
|----|--------------------|
| 1. | Coil |
| 2. | Armature spring |
| 3. | Valve plate |
| 4. | Pilot orifice |
| 5. | Diaphragm |
| 6. | Main orifice |
| 7. | Equalizing orifice |

3 Applications

It is recommended to use a filter in front of the valve. Recommended filter 50 mesh (297 microns).

Figure 3: Filter

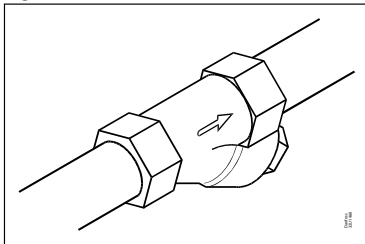

In water applications, exercise the valves at least once every 24 hours, meaning change the state of the valve. The valve exercise will minimize the risk of the valve sticking due to calcium carbonate, zinc or iron oxide build-up.

Figure 4: Exercise: Valve on/off

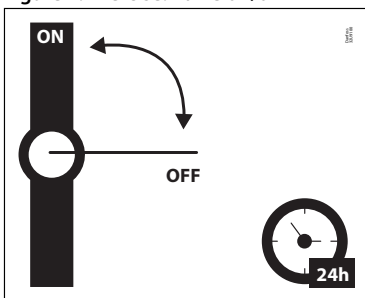

To minimize scaling, and corrosion attack it is recommended that the water passing the valve have the following values:

- Hardness 6-18 °dH to avoid scaling (chalk / lime stone build up).
- Conductivity 50 – 800 µS/cm to avoid brass dezincification and corrosion.
- Above 25°C media temperature avoid stagnant water inside the valve to avoid dezincification and corrosion attack.

4 Product specification

4.1 Technical data

Table 2: Technical data

Media	EPDM	For water and drinking water
	FKM	For oil and air. For water max. 60 °C
	NBR	For oil, water and air
Media temperature [°C]	EPDM	-30-120 °C ⁽¹⁾
	FKM	0-100 °C ⁽²⁾
	NBR	-10-90 °C
	EPDM, WRAS	0-90 °C
Ambient temperature [°C]	Up to 80 °C	
K_v value [m³/h]	DN15	4 m ³ /h
	DN20	7.5 - 8 m ³ /h
	DN25	11 m ³ /h
	DN32	18 m ³ /h
	DN40	24 m ³ /h
	DN50	40 m ³ /h
Min. Opening differential pressure [bar]	0.3 Bar	
Max. Opening differential pressure [bar]	Up to 16 bar	
Max. working pressure [bar]	Up to 16 bar (Equal to max. differential pressure)	
Max test pressure [bar]	20 bar	
Viscosity [cSt]	Max. 50 cSt	

⁽¹⁾ Low pressure steam, 4 bar: Max. 140 °C.
 BA AC/DC and BB/BE DC coils: Max. 100 °C.
 BO and BP coils: Max. 90 °C.

⁽²⁾ BO and BP coils: Max. 90 °C.

Solenoid valve, Types EV220B 15-50 and EV220BW 40-50

Differential pressure range

Table 3: Differential pressure range

ISO228/1 connection	Seal Material	Orifice [mm]	Differential pressure min. to max. [bar]	
			NC	NO
G1/2	EPDM	15	0.3-16	0.3-10
	NBR		0.3-16	
	FKM		0.3-10	
	EPDM WRAS		0.3-16	
G3/4	EPDM	20	0.3-16	
	NBR		0.3-16	
	FKM		0.3-10	
	EPDM WRAS		0.3-16	
G1	EPDM	25	0.3-16	
	NBR		0.3-16	
	FKM		0.3-10	
	EPDM WRAS		0.3-16	
G1 1/4	EPDM	32	0.3-12	
	NBR		0.3-12	
	FKM		0.3-10	
	EPDM WRAS		0.3-12	
G1 1/2	EPDM	40	0.3-12	
	NBR		0.3-12	
	FKM		0.3-10	
	EPDM WRAS		0.3-10	
G2	EPDM	50	0.3-12	
	NBR		0.3-12	
	FKM		0.3-10	
	EPDM WRAS		0.3-10	

Capacity diagram

Example, water: Capacity for EV220B 15B at differential pressure of 3 bar. Approx. 7 m³/h

Figure 5: Capacity diagram

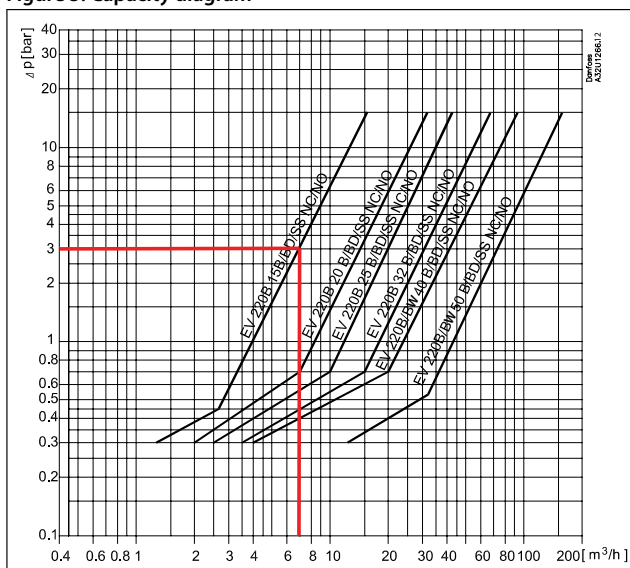
Example, air:

Capacity for EV220B 15B at inlet pressure (p_1) of 5 bar and outlet pressure (p_2) of 3.5 bar: Approx. 245 Nm³/h

Solenoid valve, Types EV220B 15-50 and EV220BW 40-50

Figure 6: Capacity diagram

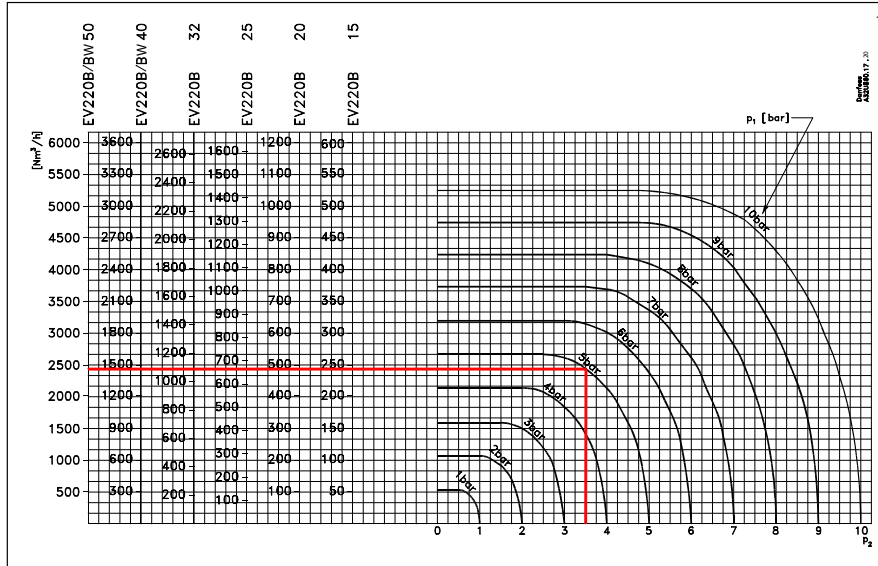

Time to open/close

Table 4: Time to open/close

Main	EV220B 15B/BD/SS	EV220B 20B/BD/SS	EV220B 25B/BD/SS	EV220B 32B/BD/SS	EV220B/BW 40B/BD/SS	EV220B/BW 50B/BD/SS
Time to open [ms] ⁽¹⁾	40	40	300	1000	1500	5000
Time to open [ms] ⁽¹⁾	350	1000	1000	2500	4000	10000

⁽¹⁾ The times are indicative and apply to water. The exact times will depend on the pressure conditions. Closing times can be changed by replacement of the equalizing orifice.

Materials

Table 5: Materials

Components	Materials	Specifications
Valve body/cover	Stainless steel	W.no. 1.4581 / AISI 318
	Brass	W.no. 2.0402
	DZR brass	CuZn36Pb2As / CZ132
Armature	Stainless steel	W.no. 1.4105 / AISI 430 FR
Armature tube	Stainless steel	W.no. 1.4306 / AISI 304L
Armature stop	Stainless steel	W.no. 1.4105 / AISI 430FR
Springs	Stainless steel	W.no. 1.4310 / AISI 301
Orifices	Stainless steel	W.no. 1.4404 / AISI316L
O-rings	EPDM, NBR or FKM	
Valve plate	EPDM, NBR or FKM	
Diaphragm	EPDM, NBR or FKM	

4.2 Dimension and weight

Table 6: Dimension and weight: Brass, DZR brass and stainless steel, NC and NO

Type	L	B	B ₁ [mm] / coil type				H	H ₁	Weight without coil
	[mm]	[mm]	BA	BB / BE	BG / BO	BP	[mm]	[mm]	[kg]
EV220B 15	80	52	32	46	68	45	99	15	0.7
EV220B 20	90	58	32	46	68	45	103	18	0.9
EV220B 25	109	70	32	46	68	45	113	22	1.3

Solenoid valve, Types EV220B 15-50 and EV220BW 40-50

Type	L	B	B ₁ [mm] / coil type				H	H ₁	Weight without coil
	[mm]	[mm]	BA	BB / BE	BG / BO	BP	[mm]	[mm]	[kg]
EV220B 32	120	82	32	46	68	45	120	27	2
EV220B / BW 40	130	95	32	46	68	45	129	32	3
EV220B / BW 50	162	113	32	46	68	45	135	37	4.8

Figure 7: Dimension

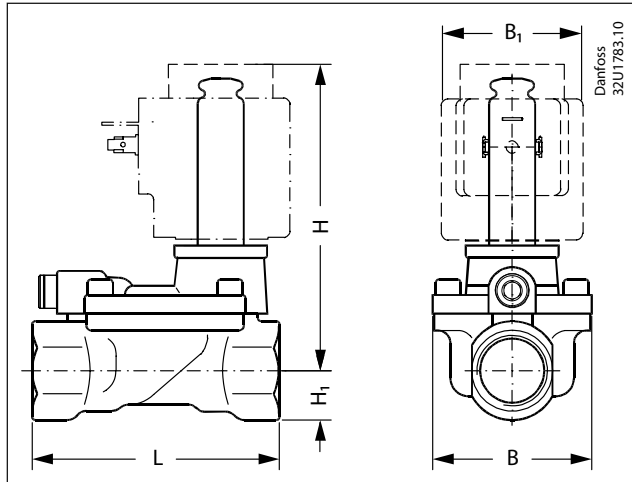

4.3 Mounting

Figure 8: Mounting angle

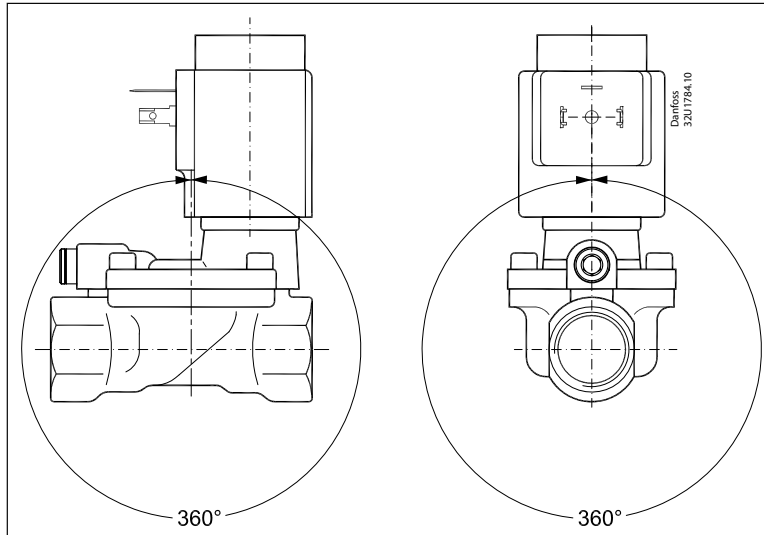

Solenoid valve, Types EV220B 15-50 and EV220BW 40-50

5 Ordering

5.1 Parts program



Table 7: Brass, DZR brass and stainless stel, valve body NC and NO

ISO228/1 connection	Orifice [mm]	K _v value [m ³ /h]	Seal Material	Approval	Type and function						
					EV220B brass		EV220B DZR	EV220B SS	EV220BW brass		
					NC	NO	NC	NC	NC	NO	
G1/2	15	4	EPDM		032U7115	032U7117	032U5815				
			NBR		032U7170	032U7180		032U8500			
			FKM		032U7116	032U7118		032U8506			
G3/4	20	8	EPDM		032U7120	032U7122	032U5820				
		7.5	NBR		032U7171	032U7181					
		8	FKM		032U7121	032U7123		032U8507			
G1	25	11	EPDM		032U7125	032U7127	032U5825				
			NBR		032U7172	032U7182		032U8502			
			FKM		032U7126	032U7128		032U8508			
G1 1/4	32	18	EPDM		032U7132	032U7134	032U5832				
			NBR		032U7173	032U7183		032U8503			
			FKM		032U7133	032U7135		032U8509			
G1 1/2	40	24	EPDM		032U7140	032U7142	032U5840	032U8504		132U4003	132U4004
			NBR		032U7174	032U7184					
			FKM		032U7141	032U7143		032U8510			
G2	50	40	EPDM		032U7150	032U7152	032U5850	032U8505		132U5003	132U5004
			NBR		032U7175	032U7185					
			FKM		032U7151	032U7153		032U8511			





5.2 Accessories

Coils

Table 8: Below coils can be used with EV220B 15 – EV220B 50, EV220BW 40-50

Coil	Type	Power consumption	Enclosure	Features
	BA / BD, screw on	8.5 - 15 W AC 14 W DC	IP00 with spade connector	IP20 with protective cap, IP67 with cable plug
	BB / BY, clip on	11 - 16 W AC 14 - 16 W DC	IP00 with spade connector	IP20 with protective cap, IP67 with cable plug
	BR, clip on	12 - 14 W AC 16 W DC	IP00 with spade connector	IP20 with protective cap, IP67 with cable plug Design for marine application

Solenoid valve, Types EV220B 15-50 and EV220BW 40-50

Coil	Type	Power consumption	Enclosure	Features
	BE, clip on	11 - 17 W AC 15 - 16 W DC	IP67	With terminal box
	BF, clip on	11 - 15 W AC 14 - 16 W DC	IP67	With 1 m cable
	BG, clip on	11 - 16 W AC 16 - 20 W DC	IP67	With terminal box
	BN, clip on	22 W AC 20 W DC	IP67	Hum free With terminal box and 1 m cable
	BO, screw on	10 W AC 10 W DC	IP67 only including seal kit 018Z0090	For explosion-risk environment zone 1. With terminal box and 5 m cable

Cable plug
Figure 9: Cable plug

Table 9: Cable plug

Cable plug size	Description	Code no
DIN 18	Cable plug IP67	042N1256

Universal electronic multi-timer, Type ET20M
Figure 10: Type ET20M

Solenoid valve, Types EV220B 15-50 and EV220BW 40-50
Table 10: Type ET20M

Application	Voltage	To use with coil	Ambient temperature	Code no.
	[V AC]		[°C]	
External adjustable timings from 1 to 45 minutes with 1 to 15 seconds drain open. with manual override (test button). Electrical connection DIN 43650 A/EN 175-301-803-A	24 - 240	BA, BD, BB	-10 - 50	042N0185

Manual override unit, tool operated

Manual override kit, used in event of power failure.

NOTE:

Valve height is increased by 16 mm.

Table 11: Manual override unit, tool operated

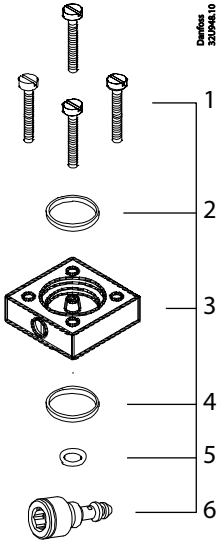
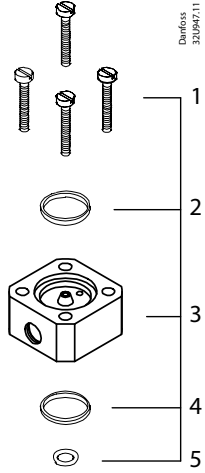
Type	Manual override unit, NBR		
	Body material		
	Brass		Stainless steel
DN15-32		032U0150	032U0149
DN40-50	032U0260		032U0149
			
	1. 4 x Screws 2. O-ring 3. Manual override body 4. O-ring 5. O-ring 6. Equalizing orifice size III ⁽¹⁾	1. 4 x Screws 2. O-ring 3. Manual override body 4. O-ring 5. O-ring	

⁽¹⁾ For FKM and NBR valves, it is recommended to change the equalizing orifice to size III, to obtain a proper function.

Manual override unit, hand operated

Manual override kit, used for manual override in event of power failure.

NOTE:

Valve height is increased by 16 mm.

Solenoid valve, Types EV220B 15-50 and EV220BW 40-50

Table 12: Manual override unit, hand operated

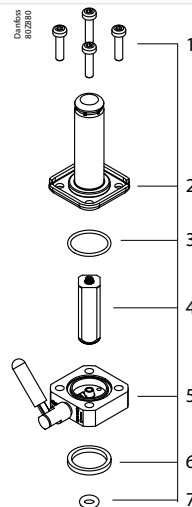
Type	Manual override unit stainless steel, EPDM
DN15-50	<p>032U7390</p>  <ol style="list-style-type: none"> 1. 4 x Screws 2. Armature tube 3. O-ring 4. Armature incl. closing spring 5. Stainless steel valve body 6. O-ring 7. O-ring

Isolating diaphragm kit

The isolating diaphragm design ensures that no fluid enters the armature area, which gives the following advantages:

The valve is resistant to aggressive fluids, impurities in the fluid and to calcareous and scale deposits.

Table 13: Isolating diaphragm kit

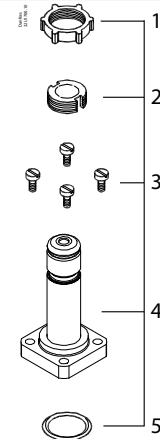
Type	Isolating diaphragm kit	
	EPDM ⁽¹⁾	FKM ⁽²⁾
DN 15-50	042U1009	042U1010
	 <ol style="list-style-type: none"> 1. Locking bottom 2. Locking nut 3. 4 x screws 4. Assembled isolating unit 5. O-ring 	

Solenoid valve, Types EV220B 15-50 and EV220BW 40-50
⁽¹⁾ Media temperature -20 - 50°C

⁽²⁾ Media temperature 0 - 50°C

Orifice
Equalizing orifice

A shorter closing time is obtained with a larger orifice (the shorter closing time, the greater risk of water hammering). A longer closing time is obtained with a smaller orifice.

The valves closing time can be changed by installing an equalizing orifice of a size which deviates from the standard valve.

Adjustable orifice

The valves closing time can be adjusted by turning the setting screw.

- A shorter closing time is obtained with a larger orifice (the shorter closing time, the greater risk of water hammering).
- A longer closing time is obtained with a smaller orifice.

Table 14: Equalizing orifice

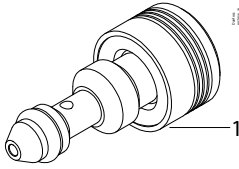
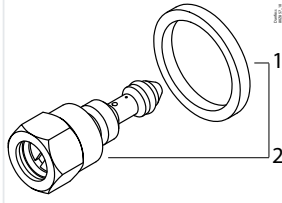
Type	Equalizing orifice size [mm]	Equalizing orifice				Adjustable orifice	
		Brass		DZR brass/ Stainless steel		Brass	
		EPDM ⁽¹⁾	FKM	EPDM ⁽¹⁾	FKM	EPDM	FKM
EV220B 15-20	0.5	032U0082		032U6310		032U0682	032U0683
EV220B 25-32-40	0.8	032U0084		032U6311			
EV220B 25-32	1.2		032U0085		032U6314		
EV220B 50	1.2	032U0086		032U6312			
EV220B 40-50	1.4		032U0087		032U6315		
							
		1. Equalizing orifice with 2 o-rings				1. Gasket 2. Adjustable orifice with o-ring	

⁽¹⁾ Approved by WRAS.

Approved by Attestation de Conformite Sanitaire (ACS).

EPDM is recommended of water (Steam max. 40 °C / 4 Bar).

Solenoid valve, Types EV220B 15-50 and EV220BW 40-50

Spare part kit for NC and NO

Table 15: Spare parts kit, NC and NO

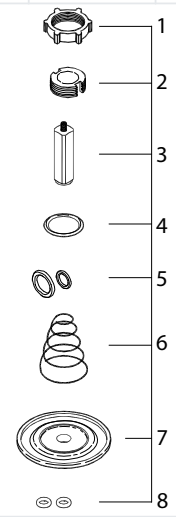
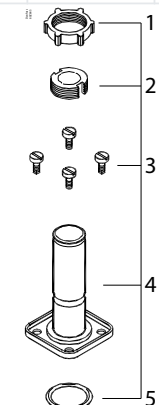
Type	Actuator kit NC brass			Actuator kit NC DZR / SS		Actuator kit NO		
	EPDM ⁽¹⁾	FKM	NBR	EPDM	FKM	EPDM ⁽²⁾	FKM	NBR
EV220B 15	032U1071	032U1072	032U6013	032U6320	032U6326	032U0296	032U0295	032U0299
EV220B 20	032U1073	032U1074	032U6014	032U6321	032U6327			
EV220B 25	032U1075	032U1076	032U6015	032U6322	032U6328			
EV220B 32	032U1077	032U1078	032U6016	032U6323	032U6329			
EV220B 40	032U1079	032U1080	032U6017	032U6324	032U6330			
EV220B 50	032U1081	032U1082	032U6018	032U6325	032U6331			
								
	<ol style="list-style-type: none"> 1. Locking button 2. Locking nut 3. Armature with valve plate and spring 4. O-ring for the armature tube 5. 2x O-rings for the equalizing orifice 6. Closing spring 7. Diaphragm 8. 2x O-rings for the pilot system 					<ol style="list-style-type: none"> 1. Locking button 2. Locking nut 3. NO actuator unit 4. O-ring for armature unit 		

⁽¹⁾ DN 15-32 approved by WRAS.

DN 15-50 (Brass and DZR) approved by attestation de conformite Sanitaire (ACS) and PZH.

DN 15-50 SS approved by PZH.

EPDM is recommended for water. (steam max. 140 °C/4 bar).

⁽²⁾ EPDM is recommended for water. (steam max. 140 °C/4 bar)

Solenoid valve, Types EV220B 15-50 and EV220BW 40-50

Spare part kit DN40 and DN50, EPDM WRAS approved

Table 16: Spare part kits DN40 and DN50

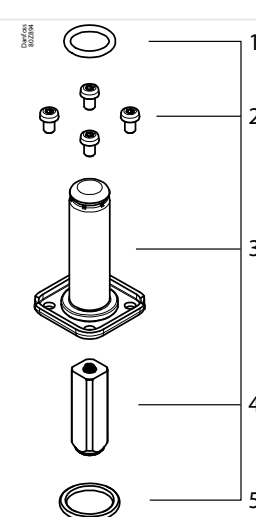
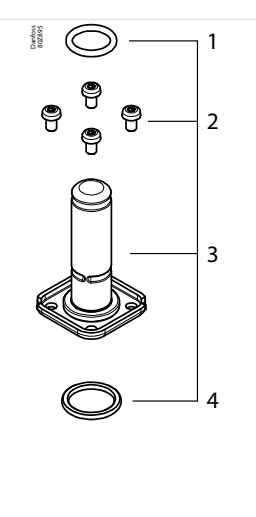
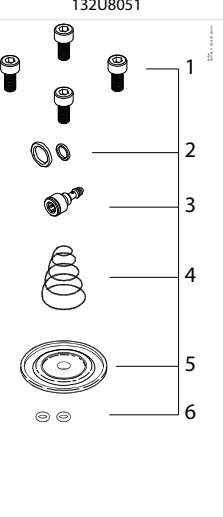
Type	Actuator kit NC	Actuator kit NO	Diaphragm kit NC and NO
EV220BW DN40	132U8080	132U8081	132U8041
EV220BW DN50	132U8080	132U8081	132U8051
			
	<ol style="list-style-type: none"> 1. O-ring 2. 4 x screws 3. Armature tube 4. Armature with spring 5. O-ring 	<ol style="list-style-type: none"> 1. O-ring 2. 4 x screws 3. NO actuator unit 4. O-ring 	<ol style="list-style-type: none"> 1. 4 x screws 2. 2 x o-rings for equalizing orifice 3. Equalizing orifice 4. Closing spring 5. Diaphragm 6. 2 x O-rings for the pilot system

6 Online support

Danfoss offers a wide range of support along with our products, including digital product information, software, mobile apps, and expert guidance. See the possibilities below.

The Danfoss Product Store



The Danfoss Product Store is your one-stop shop for everything product related—no matter where you are in the world or what area of the cooling industry you work in. Get quick access to essential information like product specs, code numbers, technical documentation, certifications, accessories, and more.

Start browsing at store.danfoss.com.

Find technical documentation



Find the technical documentation you need to get your project up and running. Get direct access to our official collection of data sheets, certificates and declarations, manuals and guides, 3D models and drawings, case stories, brochures, and much more.

Start searching now at www.danfoss.com/en/service-and-support/documentation.

Danfoss Learning



Danfoss Learning is a free online learning platform. It features courses and materials specifically designed to help engineers, installers, service technicians, and wholesalers better understand the products, applications, industry topics, and trends that will help you do your job better.

Create your Danfoss Learning account for free at www.danfoss.com/en/service-and-support/learning.

Get local information and support



Local Danfoss websites are the main sources for help and information about our company and products. Find product availability, get the latest regional news, or connect with a nearby expert—all in your own language.

Find your local Danfoss website here: www.danfoss.com/en/choose-region.

Spare Parts



Get access to the Danfoss spare parts and service kit catalog right from your smartphone. The app contains a wide range of components for air conditioning and refrigeration applications, such as valves, strainers, pressure switches, and sensors.

Download the Spare Parts app for free at www.danfoss.com/en/service-and-support/downloads.

Any information, including, but not limited to information on selection of product, its application or use, product design, weight, dimensions, capacity or any other technical data in product manuals, catalogues descriptions, advertisements, etc. and whether made available in writing, orally, electronically, online or via download, shall be considered informative, and is only binding if and to the extent, explicit reference is made in a quotation or order confirmation. Danfoss cannot accept any responsibility for possible errors in catalogues, brochures, videos and other material. Danfoss reserves the right to alter its products without notice. This also applies to products ordered but not delivered provided that such alterations can be made without changes to form, fit or function of the product. All trademarks in this material are property of Danfoss A/S or Danfoss group companies. Danfoss and the Danfoss logo are trademarks of Danfoss A/S. All rights reserved.