

Technical Information

PVG 16

Proportional Valve Group



Archivierung: 07/2023

www.danfoss.com

Revision history
Table of revisions

Date	Changed	Rev
January 2023	Updated schematic	1205
November 2022	Updated part numbers for PVBS main spools	1204
September 2022	Updated part numbers for compensated PVB	1203
July 2022	Updated PVB schematic	1202
June 2022	Removed mention of integrated LS pressure relief valve	1201
July 2021	Added part number for PVPX port plug	1104
January 2021	Minor change on page 79 (PVEO Technical Data)	1103
June 2020	Edited PVEO section	1102
May 2020	Major update - changes throughout, Changed document number from 'BC00000211' to 'BC152986484323'	1101
December 2018	Major rework of document: new sections added, data corrected.	0901
October 2018	'PVBS Main Spools' section reworked. 'Safety in Systems' and 'PVB Basic Modules Accessories' sections added.	0801
August 2018	Minor update - part number typo corrected	0702
May 2018	Major update.	0701
April 2018	Minor change for PVEA.	0602
January 2018	Major update.	0601
July 2017	Major update.	0501
February 2017	Major update.	0401
March 2016	Minor update in PVHC technical characteristics	0303
March 2016	Updated to Engineering Tomorrow design.	0302
February 2016	Drawing was updated in topic: How to select the correct spool	0301
September 2015	PVG 16 Step II	0200
Feb. 2013-Mar. 2015	Major layout revision, drawings change	BA-BF
October 2012	New Edition	AA

Contents
General Information

General Description.....	5
PVG 16 Features.....	5
Safety in Systems.....	6
Technical Data.....	7
PVG 16 Modules Overview.....	9

PVP Inlet Modules

Open Center PVP.....	11
Open Center PVP with PPRV.....	14
Open center PVP with HPCO and PVE PPRV.....	18
Closed Center PVP.....	21
Closed Center PVP with PPRV.....	23
Closed center PVPV with PPRV.....	26
Closed center PVPVM with PPRV.....	28
Open/Closed center PVP with PPRV.....	30
Open/Closed center PVPV.....	33

PVP Inlet Module Accessories

PVPX Electrical LS Pressure Unloading Valve.....	34
Part numbers for PVPX.....	35
PVPC without Check Valve.....	37
PVPC with Check Valve.....	39

PVB Basic Modules

Compensated PVB.....	42
Compensated PVB with PVLP/PVLA.....	45
Compensated PVB with LS A/B.....	49
Uncompensated PVB.....	52
Uncompensated PVB with PVLP.....	54
PVLP Shock and Anti-Cavitation Valve.....	57

PVB Basic Modules Accessories

PVLP Shock and Anti-Cavitation Valve.....	60
PVLA Suction Valve.....	62

PVBS Main Spools

PVBS Fluid Flow Characteristics - Theoretical Performance.....	64
--	----

PVBS Main Spools Part Numbers

Flow Control Spools - Closed Neutral Position.....	67
Flow Control Spools - Throttled Open Neutral Position.....	68
Flow Control Spools - Open/Closed Neutral Position.....	69

PVG 16 Actuation

PVM Manual Actuation.....	70
PVMD Cover.....	71
PVH Hydraulic Actuation.....	72
PVHC Electro-Hydraulic Actuation.....	74
PVE Electro-hydraulic Actuation.....	76
PVEO.....	78
PVEO Technical Data.....	80
PVEA Series 6 Proportional Control Actuator.....	81
PVEA Technical Data.....	82
PVG 16 connector variants.....	84

Fault Monitoring and Reaction

Generic Fault Reaction.....	85
Fault Reaction Overview.....	86

PVS End Plates

PVS/PVSI.....	88
PVS/PVSI with LX-connection.....	90

Contents

PVSI with P-, T-, LX- and M-connection.....	92
PVST with T-connection.....	94

PVAS Stay Bolts

PVAS Part Numbers.....	97
PVG 16 modules total length and weight.....	97
PVG 32/16 Combinations.....	98
PVG 256/128/32/16 Combinations.....	99

PVG 16 Combinations Valve Stack Dimensions

PVG 16 Dimensions.....	101
PVG 32/16 Dimensions.....	102
PVG 100/16 Dimensions.....	104
PVG 120/16 Dimensions.....	106
PVG 128/16 Dimensions.....	108
PVG 256/16 Dimensions.....	110

PVG 16 Applications Schematics

PVG 16 Schematic with Basic End Plate.....	112
PVG 16 with P- and T-connection end plate.....	113

General Information**General Description**

PVG is a hydraulic, load-sensing proportional valve, designed for optimal machine performance and maximum design flexibility. The PVG valve design is based on a modular concept that enables machine designers to specify a valve solution suitable for multiple market segments across multiple applications.

The PVG 16 is a member of the PVG product platform and interfaces to other valve families enabling all machine functions being controlled from one single valve stack.

PVG 16 controls work port flow up to 65 l/min [17 US gal/min] l/min and up to 420 bar [6090 psi] bar work port pressure.

The load independent proportional control valve and high performance actuator technology combined with a low pressure drop design improves the machine performance and efficiency – increasing productivity and reducing energy consumption.

PVG 16 Features

PVG load-sensing proportional valves features and benefits summarized in bullets below:

- Load-independent flow control:
 - Oil flow to an individual function is independent of the load pressure of this function
 - Oil flow to one function is independent of the load pressure of other functions
- Inlet flow up to 140 l/min [37 US gal/min] 230 l/min [61 US gal/min] when used with mid-inlet
- Easy integration with PVG 32
- Possible combination with the rest of the PVG family, when using an interface module
- Up to 12 basic modules per PVG 16 valve group
- Reliable regulation characteristics across the entire flow range
- Load sense relief valves for A and B port enables reduced energy loss at target pressure
- Several options for connection threads and flange mount
- Compact design, easy installation and serviceability

General Information

Safety in Systems

All types and brands of control valves, including proportional valves, can fail. Therefore, the necessary protection against the serious consequences of a functional failure should always be built into the system.

General safety considerations

For each application an assessment should be made for the consequences of the system in case of pressure failure and uncontrolled or blocked movements.

⚠ Warning

Because the proportional valve is used in many different applications and under different operating conditions, it is the sole responsibility of the manufacturer to ensure that all performance, safety and warning requirements of the application is met in his selection of products and complies with relevant machine specific and generic standards.

Control system example

An example of a control system using an aerial lift is shown below:

Aerial lift



This example breaks down the control system into smaller bits explaining the architecture in depth. Even though many Danfoss components are used in the PVG control system.

The function of the control system is to use the output from the PVE together other external sensors to ensure the PLUS+1 main controllers correct function of the aerial lift.

General Information

Electrical block diagram

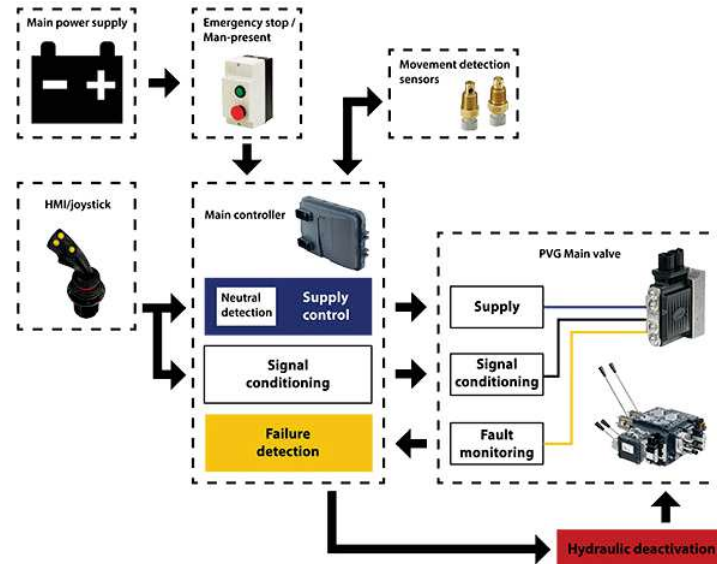
Warning

It is the responsibility of the equipment manufacturer that the control system incorporated in the machine is declared as being in conformity with the relevant machine directives.

Caution

A mix of electrical actuation and hydraulic actuation on the same valve stack is not safe. PVE and PVH are designed for different pilot pressure.

Cost-free repairs, as mentioned in Danfoss General Conditions of Sale, are carried out only at Danfoss or at service shops authorized by Danfoss.

Technical Data

Maximum pressure	Port P continuous	350 bar	[5075 psi]
	Port P intermittent	400 bar	[5800 psi]
	Port A/B continuous	380 bar	[5510 psi]
	Port A/B intermittent	420 bar	[6090 psi]
	Port T, static/dynamic	25/40 bar	[365/580 psi]
Oil flow rated	Port P	140/230 l/min	[37/61 US gal/min]
	Port A/B	65 l/min	[17 US gal/min]
Spool travel	Deadband	± 1.5 mm	[± 0.06 in]
	Proportional range	± 5 mm	[± 0.2 in]
	Float position	± 7.5 mm	[± 0.3 in]
Maximum internal leakage at 100 bar [1450 psi] and 21 mm²/s [102 SUS]	A/B → T without shock valve	20 cm ³ /min	[1.85 in ³ /min]
	A/B → T with shock valve (system setting 30 bar [435 psi])	25 cm ³ /min	[2.15 in ³ /min]
Ambient temperature		-30 → 60 °C	[-22 → 140 °F]

General Information

Oil viscosity	Operating range		12 - 75 mm ² /s	[65 - 347 SUS]
	Minimum viscosity		4 mm ² /s	[39 SUS]
	Maximum viscosity		460 mm ² /s	[2128 SUS]
Filtration	Maximum contamination (ISO 4406)		23/19/16	
PVM regulating range	Proportional		13.9°	
	Float position		22.3°	
PVM operating force	PVM + PVMD	Neutral position	2.2 ± 0.2 N·m	[5.0 ± 1.8 lbf·in]
		Maximum stroke	2.8 ± 0.2 N·m	[6.3 ± 1.8 lbf·in]
	PVM + PVE	Neutral position	2.2 ± 0.2 N·m	[5.0 ± 1.8 lbf·in]
		Maximum stroke	2.8 ± 0.2 N·m	[6.3 ± 1.8 lbf·in]
	PVM + PVH	Neutral position	2.7 ± 0.2 N·m	[23.9 ± 1.8 lbf·in]
		Maximum stroke	7.1 ± 0.2 N·m	[62.8 ± 1.8 lbf·in]
PVH pressure	Regulating range		5 - 15 bar	[75 - 220 psi]
	Maximum pilot pressure		30 bar	[435 psi]
	Maximum pressure on T-port		10 bar	[145 psi]
PVE input voltage	Supply		11 - 32 V _{DC}	
	Regulating range		25 - 75% of supply voltage	
PVE SP pin output voltage	Float		0.5 V _{DC}	
	Flow to B-port		1.25 - 2.5 V _{DC}	
	Neutral		2.5 V _{DC}	
	Flow to A-port		2.5 - 3.75 V _{DC}	
	Error		5 V _{DC}	
Oil consumption in pilot oil reduction valve			0.5 l/min	[0.13 US gal/min]

With PVS1 end plate. Using PVS end plate maximum 300 bar [4351 psi].

PVE without voltage.

Voltage is measured between spool output pin and ground (GND).

General Information
PVG 16 Modules Overview

PVG proportional valve group shown in the exploded view illustration for a quick modules navigation.

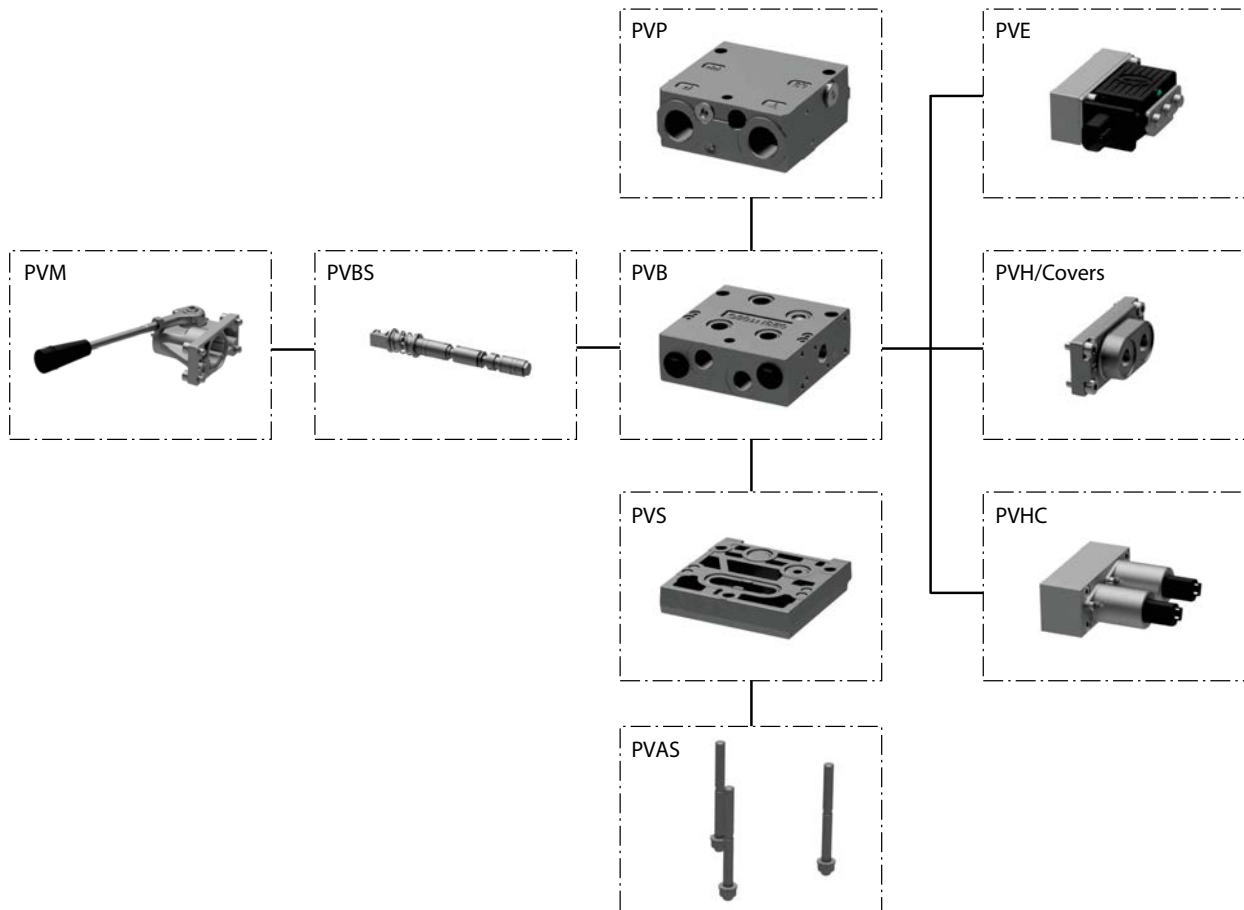
PVG 16 Modules Assembly Overview

PVG Modules Navigation:

- [PVP Inlet Modules](#) on page 10
- [PVB Basic Modules](#) on page 41
- [PVBS Main Spools](#) on page 63
- [PVM Manual Actuation](#) on page 70
- [PVE Electro-hydraulic Actuation](#) on page 76
- [PVH Hydraulic Actuation](#) on page 72
- [PVHC Electro-Hydraulic Actuation](#) on page 74
- [PVS End Plates](#) on page 87
- [PVAS Stay Bolts](#) on page 96

PVP Inlet Modules

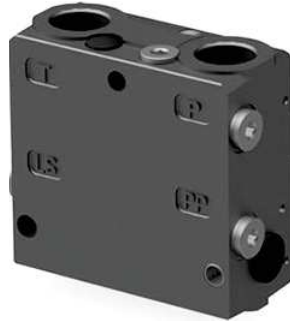
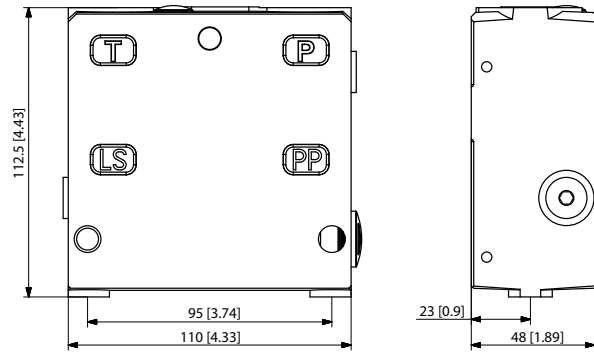
The PVG 16 PVP inlet modules, also referred to as pump side modules, act as an interface between the PVG 16 proportional valve group and the hydraulic pump and tank reservoir.

PVP Inlet Module

PVP inlet module dimensions

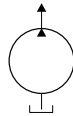
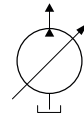
Weight: 3.1 kg [6.9 lb]

Fixed displacement pump symbol

Variable displacement pump symbol

The PVP inlet module variants are based on a generic platform with a selection of additional features, enabling you to tailor the PVP to suit the demands of any hydraulic system:

- [Open Center PVP](#) on page 11 (for fixed displacement pumps)
- [Open Center PVP with PPRV](#) on page 14 (for fixed displacement pumps)
- [Open center PVP with HPCO and PVE PPRV](#) on page 18 (for fixed displacement pumps)
- [Closed Center PVP](#) on page 21 (for variable displacement pumps)
- [Closed Center PVP with PPRV](#) on page 23 (for variable displacement pumps)
- [Closed center PVPV with PPRV](#) on page 26 (for variable displacement pumps)
- [Closed center PVPVM with PPRV](#) on page 28 (for variable displacement pumps)
- [Open/Closed center PVP with PPRV](#) on page 30
- [Open/Closed center PVPVM](#) on page 33

Technical Information
PVG 16 Proportional Valve Group
PVP Inlet Modules
Open Center PVP

The basic Open Center PVP inlet module is intended for use with fixed displacement pumps in applications, where a valve group with mechanically controlled work sections is desired, or where the pilot pressure to the valve group is supplied externally.

The Open Center PVP features:

- Integrated LS pressure relief valve
- Threaded ports for P/T/LS and M measuring gauge
- Optional LS unloading valve, PVPX
- Optional T0 facility and external T0 port
- Models with T0 port have internal T0 connection closed by default.

All modules can be manually activated with the PVM actuation.

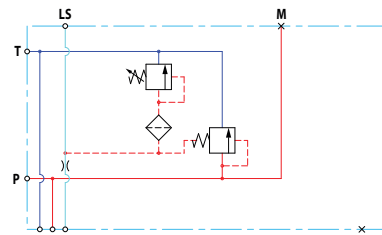
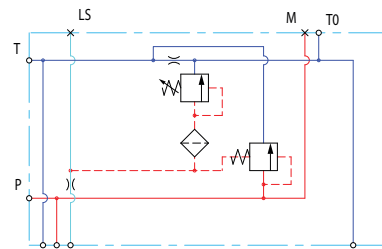
Open center PVP schematic

Open center PVP with T0

Technical specification for PVP

Max. P-port continuous	Max. P-port intermittent	Max. T-port static/ dynamic	Max. rated flow
350 [5076 psi]	400 bar [5800 psi]	25/40 bar [365/580 psi]	140 l/min [37 US gal/min]

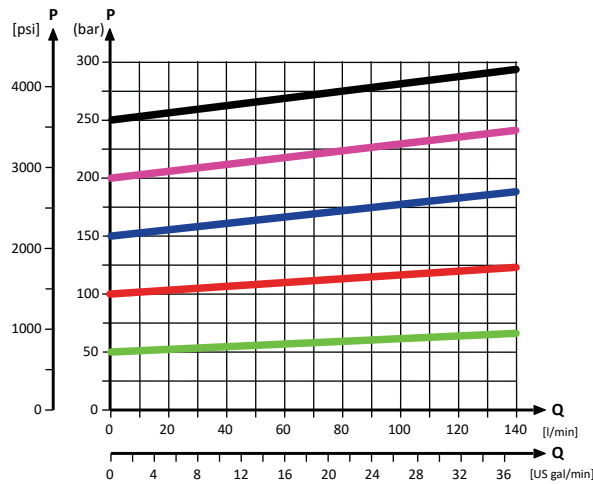
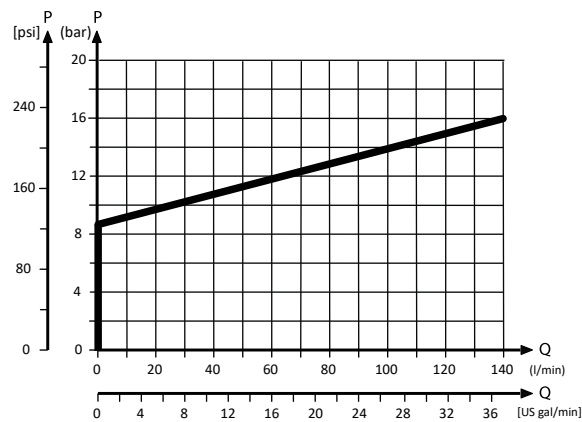
Technical specification

Parameter	Minimum	Recommended range	Maximum
Fluid temperature	-30°C [-22°F]	30 to 60°C [86 to 140°F]	90° [194°F]
Fluid viscosity	4 mm ² /s [39 SUS]	12 to 75 mm ² /s [65 to 347 SUS]	460 mm ² /s [2128 SUS]
Fluid cleanliness (mechanical activation)	23/19/16 (according to ISO 4406)		
Fluid cleanliness (PVE activation)	18/16/13 (according to ISO 4406)		
Operating temperature	Ambient: -30 to 60°C [-22 to 140°F]		

PVP Inlet Modules
Theoretical Performance Graphs
Integrated LS pressure relief valve characteristics

Neutral by-pass pressure drop characteristics

Part numbers for Open Center PVP

Part number	P-port	T-port	LS-, M-port (LS1 ^{**})	T0-port	Mounting	PVPX [*]
157B5000	G1/2"	G3/4"	G1/4"	-	M8	-
157B5100	G3/4"			-		-
157B5102	G3/4"			-		Yes
157B5200	7/8-14 UNF	1 1/16-12 UNF	1/2-20 UNF	-	5/16-18 UNC	-
157B5300	1-1/16 UN			-		-
11008852 ¹	G1/2	G3/4	G1/4 (G1/8)	-	M8	-
11030545	G3/4	G3/4	G1/4 (G1/4)	G1/4	M8	-
11053974	G3/4	G3/4	G1/4 (G1/4)	G1/4	M8	-
11151852	1 1/16-12 UNF	1 1/16-12 UNF	9/16-18 UNF	9/16-18 UNF	M8	-
157B5908	1 1/16-12 UNF	1 1/16-12 UNF	1/2-20 UNF	-	M8	-
157B5921	JIS 1/2	JIS 3/4	JIS 1/4	-	M8	-

PVP Inlet Modules
Part numbers for Open Center PVP (continued)

Part number	P-port	T-port	LS-, M-port (LS1 ^{**})	T0-port	Mounting	PVPX [*]
157B5925	JIS 3/4	JIS 3/4	JIS 1/4	-	M8	-
157B5945	G1/2	G3/4	G1/4 (G1/8)	-	M8	-
157B5990²	1 1/16-12 UNF	1 1/16-12 UNF	-	-	M8	-

^{**} LS1 is an extra LS-port.

^{*} For more information see *PVPX Electrical LS Pressure Unloading Valve* on page 34.

¹ Dampened LS response

² No relief valve

PVP Inlet Modules
Open Center PVP with PPRV

The Open Center PVP inlet with integrated pilot pressure reduction valve (PPRV) is intended for use with fixed displacement pumps in applications, where a valve group with electro-hydraulically or hydraulically controlled work sections is desired (PVE or PVH/PVHC).

The Open Center PVP with PPRV features:

- Integrated LS pressure relief valve
- Threaded ports for P/T/LS and M measuring gauge
- Integrated pilot pressure reducing valve (PPRV) for PVE or PVH/PVHC
- Optional external pilot pressure port (Pp)
- Optional LS unloading valve, PVPX
- Models with T0 port have internal T0 connection closed by default.

All modules can be manually activated with the PVM actuation.

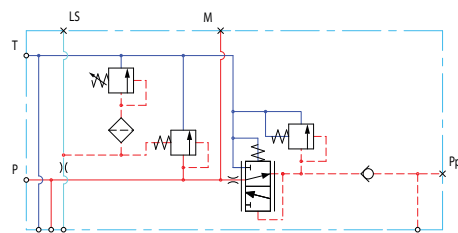
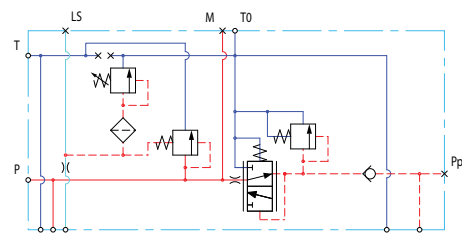
Open center PVP with PPRV schematic

Open center PVP with PPRV and T0

Technical specification for PVP

Max. P-port continuous	Max. P-port intermittent	Max. T-port static/ dynamic	Max. rated flow
350 [5076 psi]	400 bar [5800 psi]	25/40 bar [365/580 psi]	140 l/min [37 US gal/min]

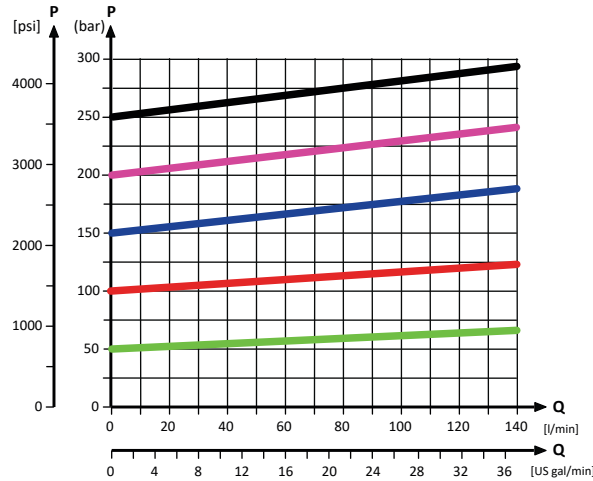
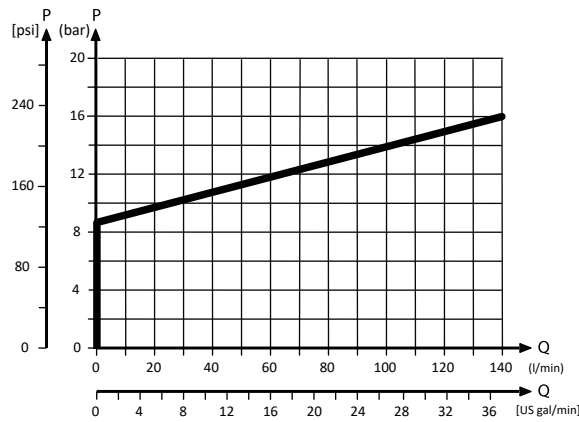
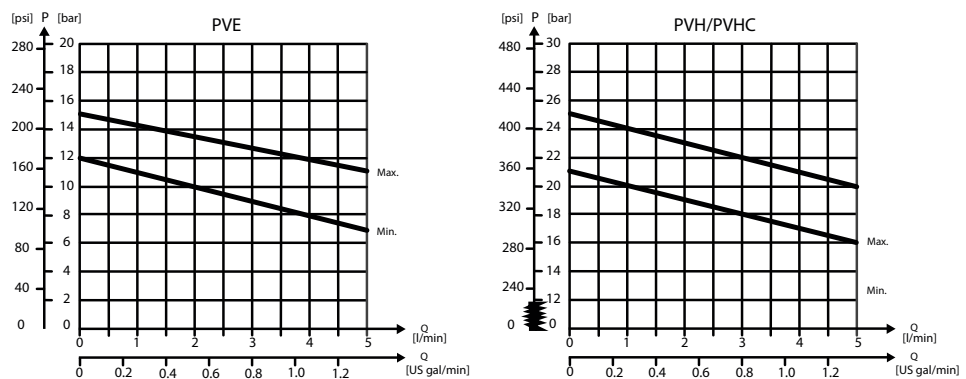
Technical specification

Parameter	Minimum	Recommended range	Maximum
Fluid temperature	-30°C [-22°F]	30 to 60°C [86 to 140°F]	90° [194°F]
Fluid viscosity	4 mm ² /s [39 SUS]	12 to 75 mm ² /s [65 to 347 SUS]	460 mm ² /s [2128 SUS]
Fluid cleanliness (mechanical activation)	23/19/16 (according to ISO 4406)		
Fluid cleanliness (PVE activation)	18/16/13 (according to ISO 4406)		
Operating temperature	Ambient: -30 to 60°C [-22 to 140°F]		

PVP Inlet Modules
Theoretical Performance Graphs
Integrated LS pressure relief valve characteristics

Neutral by-pass pressure drop characteristics

Pilot pressure reduction valve characteristics

PVP Inlet Modules
Part numbers for Open Center PVP with PPRV

Part number	Actuation	P-port	T-port	LS-port	M-port	Pp-port	T0-port	Mounting	PVPX*
157B5010	PVE	G1/2"	G3/4"	G1/4"	G1/4"	-	-	M8	-
157B5012	PVE	G1/2"	G3/4"	G1/4"	G1/4"	-	-	M8	Yes
157B5110	PVE	G3/4"	G3/4"	G1/4"	G1/4"	-	-	M8	-
157B5112	PVE	G3/4"	G3/4"	G1/4"	G1/4"	-	-	M8	Yes
157B5180	PVE	G3/4"	G3/4"	G1/4"	G1/4"	G1/4"	-	M8	-
157B5190	PVH/PVHC	G3/4"	G3/4"	G1/4"	G1/4"	G1/4"	-	M8	-
157B5210	PVE	7/8-14 UNF	1 1/16-12 UNF	1/2-20 UNF	1/2-20 UNF	-	-	5/16-18 UNC	-
157B5212	PVE	7/8-14 UNF	1 1/16-12 UNF	1/2-20 UNF	1/2-20 UNF	-	-	5/16-18 UNC	Yes
157B5310	PVE	1 1/16-12 UNF	1 1/16-12 UNF	1/2-20 UNF	1/2-20 UNF	-	-	5/16-18 UNC	-
157B5312	PVE	1 1/16-12 UNF	1 1/16-12 UNF	1/2-20 UNF	1/2-20 UNF	-	-	5/16-18 UNC	Yes
157B5380	PVE	1 1/16-12 UNF	1 1/16-12 UNF	9/16-18 UNF	9/16-18 UNF	9/16-18 UNF	-	5/16-18 UNC	-
157B5390	PVH/PVHC	1 1/16-12 UNF	1 1/16-12 UNF	9/16-18 UNF	9/16-18 UNF	9/16-18 UNF	-	5/16-18 UNC	-
11008850	PVE	G3/4	G3/4	G1/4	G1/4	-	-	M8	Yes
11013317 ¹	PVE	G3/4	G3/4	G1/4	G1/4	G1/4	G1/4	M8	-
11020964	PVE	1 1/16-12 UNF	1 1/16-12 UNF	1/2-20 UNF	1/2-20 UNF	-	-	M8	-
11087590 ¹	PVH/PVHC	G3/4	G3/4	G1/4	G1/4	G1/4	-	M8	-
11090453	PVE	JIS 3/4	JIS 3/4	JIS 1/4	JIS 1/4	JIS 1/4	JIS 1/4	M8	-
11119429 ²	PVE	G3/4	G3/4	G1/4	G1/4	G1/4	-	M8	-
11124965	PVH/PVHC	G3/4	G3/4	G1/4	G1/4	G1/4	G1/4	M8	Yes
11124966	PVH/PVHC	G3/4	G3/4	G1/4	G1/4	G1/4	G1/4	M8	-
11130941 ²	PVE	1 1/16-12 UNF	1 1/16-12 UNF	9/16-18 UNF	9/16-18 UNF	9/16-18 UNF	-	5/16-18 UNC	-
11167773	PVH/PVHC	1 1/16-12 UNF	1 1/16-12 UNF	1/2-20 UNF	1/2-20 UNF	-	-	5/16-18 UNC	Yes
11187356 ⁴	PVE	G1/2	G3/4	G1/4	G1/4	-	-	M8	Yes
11190123	PVH/PVHC	G1/2	G3/4	G1/4	G1/4	-	-	M8	Yes
11196947	PVE	G3/4	G3/4	G1/4	G1/4	-	G1/4	M8	-
11225941	PVE	1 1/16-12 UNF	1 1/16-12 UNF	9/16-18 UNF	9/16-18 UNF	9/16-18 UNF	9/16-18 UNF	5/16-18 UNC	-
157B5135 ³	PVE	G3/4	G3/4	G1/4	G1/4	G1/4	G1/4	M8	-
157B5904 ²	PVE	G3/4	G3/4	G1/4	G1/4	G1/4	-	M8	-
157B5923	PVE	JIS 1/2	JIS 3/4	JIS 1/4	JIS 1/4	-	-	M8	-
157B5926	PVE	JIS 3/4	JIS 3/4	JIS 1/4	JIS 1/4	-	-	M8	-
157B5934	PVE	G3/4	G3/4	G1/4	G1/4	-	-	M8	-
157B5943 ²	PVH/PVHC	G3/4	G3/4	G1/4	G1/4	G1/4	-	M8	-
157B5953 ²	PVE	G3/4	G3/4	G1/4	G1/4	-	-	M8	Yes
157B5954	PVE	G3/4	G3/4	G1/4	G1/4	G1/4	-	M8	-
157B5960	PVE	1 1/16-12 UNF	1 1/16-12 UNF	9/16-18 UNF	9/16-18 UNF	-	9/16-18 UNF	5/16-18 UNF	-
157B5966 ²	PVE	G3/4	G3/4	G1/4	G1/4	-	-	M8	Yes
157B5976	PVE	G3/4	G3/4	G1/4	G1/4	-	-	M8	Yes

PVP Inlet Modules
Part numbers for Open Center PVP with PPRV (continued)

Part number	Actuation	P-port	T-port	LS-port	M-port	Pp-port	T0-port	Mounting	PVPX*
157B5977 ^{1,4}	PVE	G3/4	G3/4	G1/4	G1/4	-	-	M8	-
11101194	PVE	M22 x 1.5	M22 x 1.5	M12 x 1.5	M10 x 1	-	M16 x 1.5	M8	-

* For more information please see the topic *PVPX Electrical LS Pressure Unloading Valve*.

¹ Dampened LS response

² Pressure adjustment spool with check valve

³ Internal T0 connection

⁴ Low flow pressure adjustment spool

All modules can be manually activated with the PVM. For more information please see *PVM Manual Actuation* on page 70.

PVP Inlet Modules
Open center PVP with HPCO and PVE PPRV

The Open Center PVP inlet with integrated High Pressure Carry Over (HPCO) functionality is intended for use with fixed displacement pumps in applications where one pump supply for multiple hydraulic subsystems is desired.

The integrated HPCO functionality guides the excess flow of the PVG 16 valve group to the external hydraulic subsystem(s), giving priority to the PVG 16 work functions.

The Open Center PVP with HPCO and PVE PPRV features:

- Integrated LS pressure relief valve
- Threaded ports for P/T/LS/HPCO and M measuring gauge
- Integrated pilot pressure reducing valve (PPRV) for PVE
- Optional T0 facility and external T0 port
- Optional external pilot pressure port (Pp)
- Optional LS unloading valve, PVPX
- Models with T0 port have internal T0 connection closed by default.

Only applicable with PVST end plates with separate T-port due to blocked T-lines for HPCO functionality.

Open center PVP with HPCO, PPRV, and T0

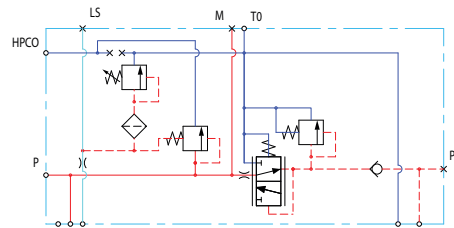

Technical specification for PVP

Max. P-port continuous	Max. P-port intermittent	Max. T-port static/ dynamic	Max. rated flow
350 [5076 psi]	400 bar [5800 psi]	25/40 bar [365/580 psi]	140 l/min [37 US gal/min]

Technical specification

Parameter	Minimum	Recommended range	Maximum
Fluid temperature	-30°C [-22°F]	30 to 60°C [86 to 140°F]	90° [194°F]
Fluid viscosity	4 mm ² /s [39 SUS]	12 to 75 mm ² /s [65 to 347 SUS]	460 mm ² /s [2128 SUS]
Fluid cleanliness (mechanical activation)	23/19/16 (according to ISO 4406)		
Fluid cleanliness (PVE activation)	18/16/13 (according to ISO 4406)		
Operating temperature	Ambient: -30 to 60°C [-22 to 140°F]		

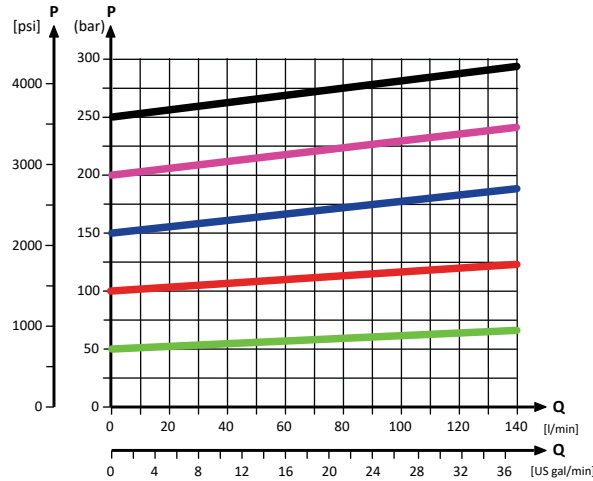
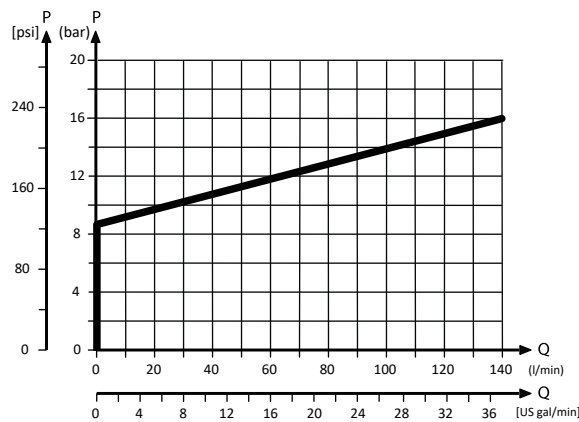
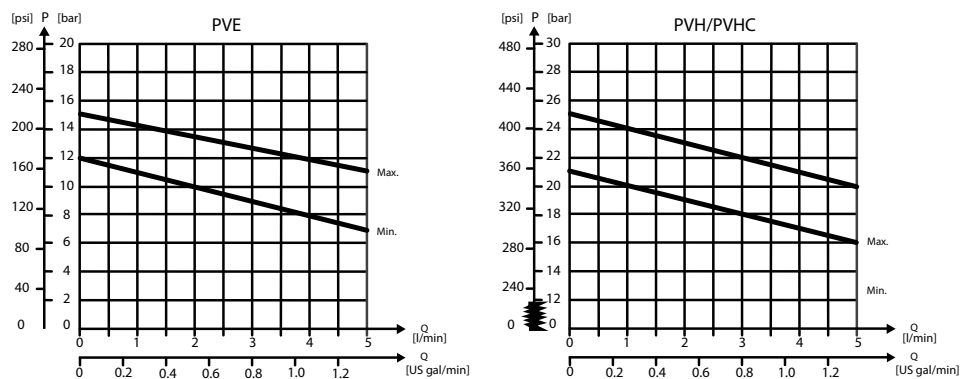
PVP Inlet Modules
Theoretical Performance Graphs
Integrated LS pressure relief valve characteristics

Neutral by-pass pressure drop characteristics

Pilot pressure reduction valve characteristics

Technical Information

PVG 16 Proportional Valve Group
PVP Inlet Modules
Part numbers for OC PVP (HPCO and PPRV)

Part number	P-port	HPCO-port	LS-port	M-port	Pp-port	T0-port	Mounting	PVPX*
157B5140	G3/4"	G3/4"	G1/4"	G1/4"	G1/4"	G1/4"	M8	-
157B5142	G3/4"	G3/4"	G1/4"	G1/4"	G1/4"	G1/4"	M8	Yes
157B5340	1 1/16-12 UNF	1 1/16-12 UNF	1/2-20 UNF	1/2-20 UNF	1/2-20 UNF	1/2-20 UNF	5/16-18 UNC	-
157B5342	1 1/16-12 UNF	1 1/16-12 UNF	1/2-20 UNF	1/2-20 UNF	1/2-20 UNF	-	5/16-18 UNC	Yes
157B5961	M27x2	M27x2	M14x1.5	M14x1.5	-	M14x1.5	M8	-
11101195	M22x1.5 M16x1.5 (P2)	M22x1.5	M12x1.5	M10x1	-	M16x1.5	M8	-

 * For more information please see the topic *PVPX Electrical LS Pressure Unloading Valve*.

PVP Inlet Modules
Closed Center PVP

The basic Closed Center PVP inlet is intended for use with variable displacement pumps in applications where a valve group with mechanically controlled work sections is desired, or where the pilot pressure to the valve group is supplied externally.

The Closed Center PVP features:

- Integrated LS pressure relief valve
- Threaded ports for P/T/LS and M measuring gauge
- Optional LS unloading valve, PVPX
- Optional T0 facility and external T0 port
- Models with T0 port have internal T0 connection closed by default.

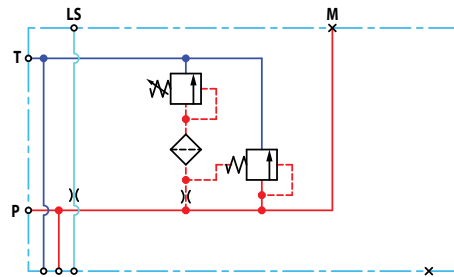
Closed center PVP schematic

Technical specification for PVP

Max. P-port continuous	Max. P-port intermittent	Max. T-port static/ dynamic	Max. rated flow
350 [5076 psi]	400 bar [5800 psi]	25/40 bar [365/580 psi]	140 l/min [37 US gal/min]

Technical specification

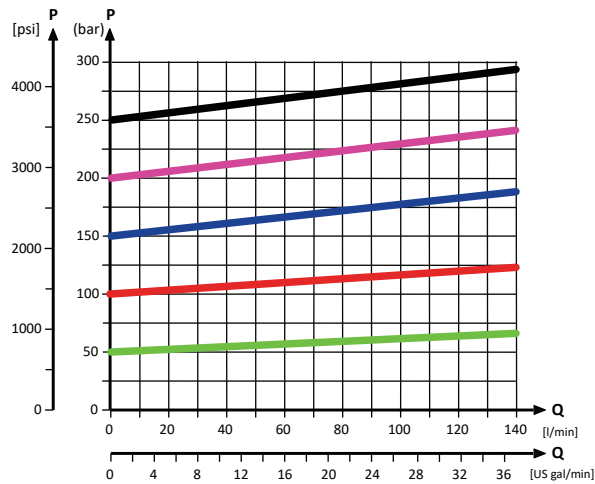
Parameter	Minimum	Recommended range	Maximum
Fluid temperature	-30°C [-22°F]	30 to 60°C [86 to 140°F]	90° [194°F]
Fluid viscosity	4 mm ² /s [39 SUS]	12 to 75 mm ² /s [65 to 347 SUS]	460 mm ² /s [2128 SUS]
Fluid cleanliness (mechanical activation)	23/19/16 (according to ISO 4406)		
Fluid cleanliness (PVE activation)	18/16/13 (according to ISO 4406)		
Operating temperature	Ambient: -30 to 60°C [-22 to 140°F]		

PVP Inlet Modules
Theoretical Performance Graphs
Integrated LS pressure relief valve characteristics

Part numbers for Closed Center PVP

Part number	P-port	T-port	LS-port (LS1 ^{**})	M-port	T0-port	Mounting	PVPX [*]
11030683	G3/4	G3/4	G1/4 (G1/4)	G1/4	G1/4	M8	-
157B5001	G1/2	G3/4	G1/4	G1/4	-	M8	-
157B5101	G3/4	G3/4	G1/4	G1/4	-	M8	-
157B5103	G3/4	G3/4	G1/4	G1/4	-	M8	Yes
157B5201	7/8-14 UNF	1 1/16-12 UNF	1/2-20 UNF	1/2-20 UNF	--	5/16-18 UNC	-
157B5301	1 1/16-12 UNF	1 1/16-12 UNF	1/2-20 UNF	1/2-20 UNF	-	5/16-18 UNC	-
15B5907	1 1/16-12 UNF	1 1/16-12 UNF	1/2-20 UNF	1/2-20 UNF	-	M8	-
157B5922	JIS 1/2	JIS 3/4	JIS 1/4	JIS 1/4	-	M8	-
157B5927	JIS 3/4	JIS 3/4	JIS 1/4	JIS 1/4	-	M8	-
157B5946	G1/2	G3/4	G1/4 (G1/8)	G1/4	-	M8	-

^{**} LS1 is an extra LS-port

^{*} For more information see [PVPX Electrical LS Pressure Unloading Valve](#) on page 34

PVP Inlet Modules
Closed Center PVP with PPRV

The Closed Center PVP inlet with integrated pilot pressure reduction valve (PPRV) is intended for use with variable displacement pumps in applications where a valve group with electro-hydraulic or hydraulically controlled work sections is desired.

The Closed Center PVP with PPRV features:

- Integrated LS pressure relief valve
- Threaded ports for P/T/LS and M measuring gauge
- Integrated pilot pressure reducing valve (PPRV) for PVE or PVH/PVHC
- Optional external pilot pressure port (Pp)
- Optional LS unloading valve, PVPX
- Models with T0 port have internal T0 connection closed by default.

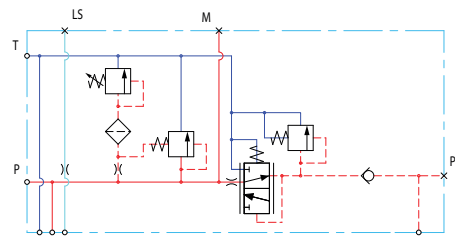
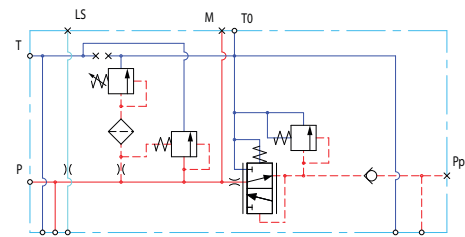
Closed center PVP with PPRV schematic

Closed center PVP with PPRV and T0

Technical specification for PVP

Max. P-port continuous	Max. P-port intermittent	Max. T-port static/ dynamic	Max. rated flow
350 [5076 psi]	400 bar [5800 psi]	25/40 bar [365/580 psi]	140 l/min [37 US gal/min]

Technical specification

Parameter	Minimum	Recommended range	Maximum
Fluid temperature	-30°C [-22°F]	30 to 60°C [86 to 140°F]	90° [194°F]
Fluid viscosity	4 mm ² /s [39 SUS]	12 to 75 mm ² /s [65 to 347 SUS]	460 mm ² /s [2128 SUS]
Fluid cleanliness (mechanical activation)	23/19/16 (according to ISO 4406)		
Fluid cleanliness (PVE activation)	18/16/13 (according to ISO 4406)		
Operating temperature	Ambient: -30 to 60°C [-22 to 140°F]		

PVP Inlet Modules

Theoretical Performance Graphs

Integrated LS pressure relief valve characteristics

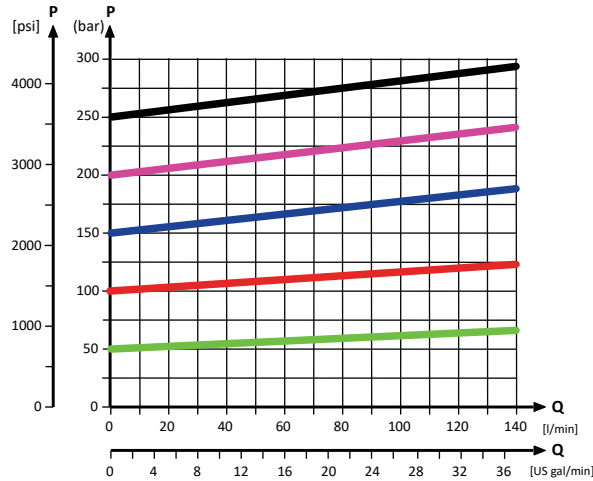

Pilot pressure reduction valve characteristics

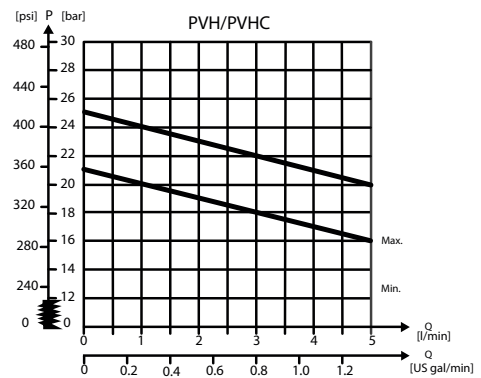
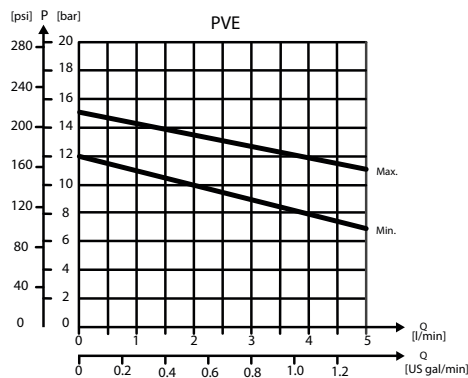

Part numbers for Closed Center PVP with PPRV

Part number	Actuation	P-port	T-port	LS-port (LS1**)	M-port	Pp-port	T0-port	Mounting	PVPX*
157B5011	PVE	G1/2"	G3/4"	G1/4"	G1/4"	-	-	M8	-
157B5013	PVE	G1/2"	G3/4"	G1/4"	G1/4"	-	-	M8	Yes
157B5111	PVE	G3/4"	G3/4"	G1/4"	G1/4"	-	-	M8	-
157B5113	PVE	G3/4"	G3/4"	G1/4"	G1/4"	-	-	M8	Yes
157B5181	PVE	G3/4"	G3/4"	G1/4"	G1/4"	G1/4"	-	M8	-
157B5191	PVH/PVHC	G3/4"	G3/4"	G1/4"	G1/4"	G1/4"	-	M8	-
157B5211	PVE	7/8-14 UNF	1 1/16-12 UNF	1/2-20 UNF	1/2-20 UNF	-	-	5/16-18 UNC	-
157B5213	PVE	7/8-14 UNF	1 1/16-12 UNF	1/2-20 UNF	1/2-20 UNF	-	-	5/16-18 UNC	Yes
157B5311	PVE	1 1/16-12 UNF	1 1/16-12 UNF	1/2-20 UNF	1/2-20 UNF	-	-	5/16-18 UNC	-
157B5313	PVE	1 1/16-12 UNF	1 1/16-12 UNF	1/2-20 UNF	1/2-20 UNF	-	-	5/16-18 UNC	Yes

Technical Information
PVG 16 Proportional Valve Group

PVP Inlet Modules
Part numbers for Closed Center PVP with PPRV (continued)

Part number	Actuation	P-port	T-port	LS-port (LS1)**	M-port	Pp-port	T0-port	Mounting	PVPX*
157B5381	PVE	1 1/16-12 UNF	1 1/16-12 UNF	9/16-18 UNF	9/16-18 UNF	9/16-18 UNF	-	5/16-18 UNC	-
157B5391	PVH/PVHC	1 1/16-12 UNF	1 1/16-12 UNF	9/16-18 UNF	9/16-18 UNF	9/16-18 UNF	-	5/16-18 UNC	

** LS1 is an extra LS-port

 * For more information please see [PVPX Electrical LS Pressure Unloading Valve](#) on page 34

All modules can be manually activated with the PVM actuation.

 For more information, please see [PVM Manual Actuation](#) on page 70.

PVP Inlet Modules
Closed center PVPV with PPRV

The Closed Center PVPV inlet with integrated pilot pressure reduction valve (PPRV) is intended for use with variable displacement pumps in applications where a valve group with electro-hydraulic or hydraulically controlled work sections is desired.

The Closed Center PVPV with PPRV features:

- Optional shock/anti-cavitation valve facility (PVLV)
- Threaded ports for P/T/LS and M measuring gauge
- Integrated pilot pressure reducing valve (PPRV) for PVE or PVH/PVHC
- Models with T0 port have internal T0 connection closed by default.

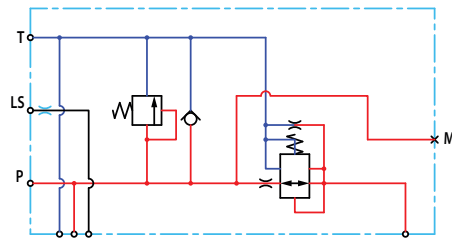
Hydraulic schematic

Technical specification for PVP

Max. P-port continuous	Max. P-port intermittent	Max. T-port static/dynamic	Max. rated flow
350 [5076 psi]	400 bar [5800 psi]	25/40 bar [365/580 psi]	150 l/min [37 US gal/min]

Technical specification

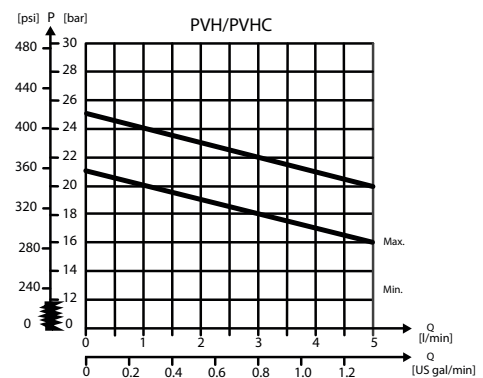
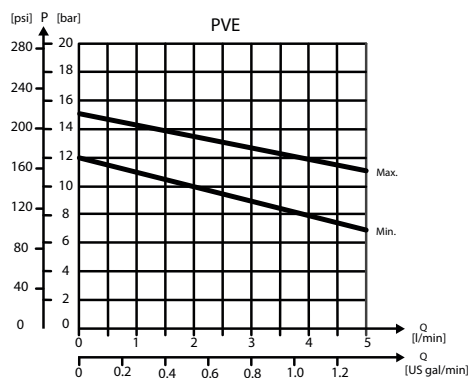
Parameter	Minimum	Recommended range	Maximum
Fluid temperature	-30°C [-22°F]	30 to 60°C [86 to 140°F]	90° [194°F]
Fluid viscosity	4 mm ² /s [39 SUS]	12 to 75 mm ² /s [65 to 347 SUS]	460 mm ² /s [2128 SUS]
Fluid cleanliness (mechanical activation)	23/19/16 (according to ISO 4406)		
Fluid cleanliness (PVE activation)	18/16/13 (according to ISO 4406)		
Operating temperature	Ambient: -30 to 60°C [-22 to 140°F]		

Pilot pressure reduction valve characteristics

Technical Information
PVG 16 Proportional Valve Group
PVP Inlet Modules
Part numbers for Closed Center PVPV with PPRV

Part number	Actuator	P-port	T-port (T2)	LS-port	M-port	Pp-port	T0-port (T02)	Mounting	PVLP	
11012350 ¹	PVE	M27x2.0	M33x2.0	M14x1.5	M14x1.5	-	-	M8	-	
11003806		M27x2.0	M27x2.0 (M14x1.5)	M14x1.5	M14x1.5	-	M14x1.5 (M14x1.5)	M8	-	
11008854 ²		G1	G1	G1/4	G1/4	-	-	M8	Yes	
11124107		1 5/16-12	1 1/16-12	9/16-18	9/16-18	-	-	M8	Yes	
11196949		G1	G1	-	-	G1/4	-	M8	Yes	
157B5911		1 5/16-12	1 5/16-12	9/16-18	9/16-18	-	-	5/16-18	-	
157B5913		1 5/16-12	1 5/16-12	9/16-18	9/16-18	-	-	5/16-18	Yes	
157B5938		G1	G1	G1/4	G1/4	-	-	M8	-	
157B5941		G1	G1	G1/4	G1/4	-	-	M8	Yes	
157B5948 ³		G1	G1	G1/4	G1/4	-	-	M8	Yes	
157B5973 ⁴		G1	G1	G1/4	G1/4	-	-	M8	Yes	
157B5978		M27x2.0	M33x2.0	M14x1.5	M14x1.5	-	-	M8	-	
11008856		PVH/PVHC	G1	G1	G1/4	G1/4	-	-	M8	Yes
11051803			1 5/16-12	1 5/16-12	9/16-18	9/16-18	-	-	5/16-18	Yes
157B5916	1 5/16-12		1 5/16-12	9/16-18	9/16-18	-	-	5/16-18	-	
157B5963	1 1/16-12		1 1/16-12	7/16-20	-	-	9/16-18	M8	-	

¹ No LS-orifice

² Internal T0 connection

³ 0.4 mm hole in the pilot reduction cone (standard 0.8 mm)

⁴ HPCO-facility

All modules can be manually activated with the PVM actuation.

PVP Inlet Modules
Closed center PVPVM with PPRV

The Closed Center PVPVM mid-inlet module with integrated pilot pressure reduction valve (PPRV) is intended for use with variable displacement pumps in applications where a valve group with electro-hydraulic or hydraulically controlled work sections is desired.

Using a PVPVM module in a valve group requires a 180° degree rotation of the PVG work sections on one side.

The Closed Center PVPVM with PPRV features:

- Optional shock/anti-cavitation valve facility (PVLV)
- Threaded ports for P/T/LS and M measuring gauge
- Integrated pilot pressure reducing valve (PPRV) for PVE or PVH/PVHC

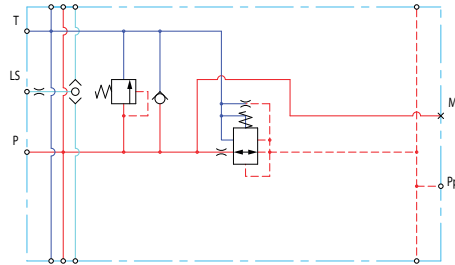
Hydraulic schematic

Technical specification for PVP

Max. P-port continuous	Max. P-port intermittent	Max. T-port static/dynamic	Max. rated flow
350 [5076 psi]	400 bar [5800 psi]	25/40 bar [365/580 psi]	230 l/min [61 US gal/min]

Technical specification

Parameter	Minimum	Recommended range	Maximum
Fluid temperature	-30°C [-22°F]	30 to 60°C [86 to 140°F]	90° [194°F]
Fluid viscosity	4 mm ² /s [39 SUS]	12 to 75 mm ² /s [65 to 347 SUS]	460 mm ² /s [2128 SUS]
Fluid cleanliness (mechanical activation)	23/19/16 (according to ISO 4406)		
Fluid cleanliness (PVE activation)	18/16/13 (according to ISO 4406)		
Operating temperature	Ambient: -30 to 60°C [-22 to 140°F]		

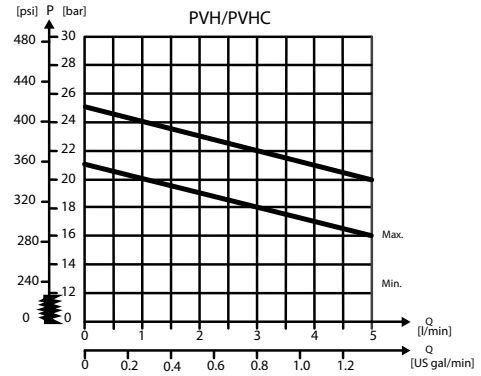
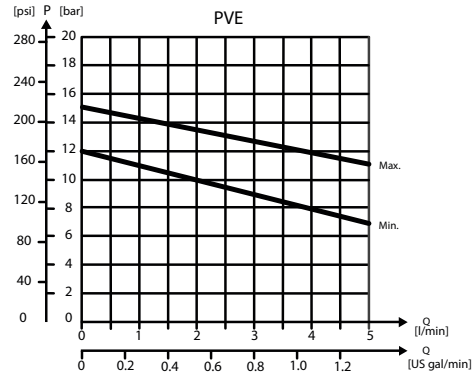
Technical Information

PVG 16 Proportional Valve Group
PVP Inlet Modules
Pilot pressure reduction valve characteristics

Part numbers for Closed Center PVPVM with PPRV

Part number	Actuator	P-port	T-port	LS-port	M-port	Pp-port	Mounting	PVLP
157B5914	PVE	1 5/16-12 UNF	1 5/16-12 UNF	9/16-18 UNF	9/16-18 UNF	G1/4	5/16-18 UNC	Yes
157B5937		G1	G1	G1/4	G1/4	G1/4	M8	-
157B5940		G1	G1	G1/4	G1/4	G1/4	M8	Yes
157B5912		1 5/16-12 UNF	1 5/16-12 UNF	9/16-18 UNF	9/16-18 UNF	G1/4	5/16-18 UNC	-
11083156	PVH/PVHC	1 1/16-12 UNF	1 1/16-12 UNF	9/16-18 UNF	9/16-18 UNF	G1/4	5/16-18 UNC	Yes
157B5986		G1	G1	G1/4	G1/4	G1/4	M8	Yes

All modules can be manually activated with the PVM actuation.

PVP Inlet Modules
Open/Closed center PVP with PPRV

The Open Center/Closed Center PVP with integrated pilot pressure reduction valve (PPRV) is intended for use with fixed or variable displacement pumps in applications where the application manufacturer does not determine the pump type.

The modules allow an easy switch between Open Center and Closed Center configuration by means of an external hexagon selector key. Variants also feature an LS boost functionality, increasing the LS pressure to the pump LS regulator with a constant 6 bar, compensating for potential LS bleed-off and leakage.

The Open/closed center PVP with PPRV features:

- Integrated OC/CC selector
- Integrated LS pressure relief valve
- Threaded ports for P/T/LS and M measuring gauge
- Integrated pilot pressure reducing valve (PPRV) for PVE or PVH/PVHC
- Optional LS boost functionality

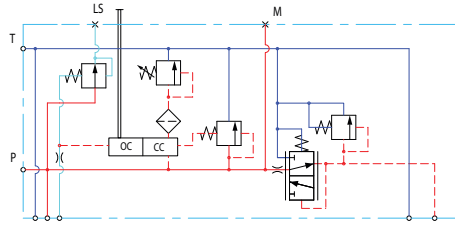
Hydraulic schematic

Technical specification for PVP

Max. P-port continuous	Max. P-port intermittent	Max. T-port static/dynamic	Max. rated flow
350 [5076 psi]	400 bar [5800 psi]	25/40 bar [365/580 psi]	140 l/min [37 US gal/min]

Technical specification

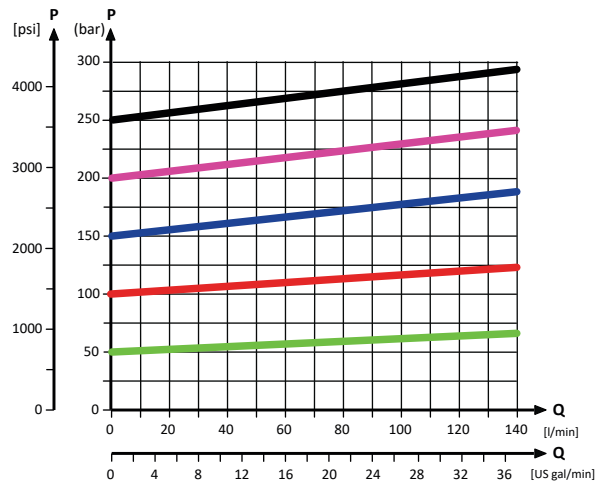
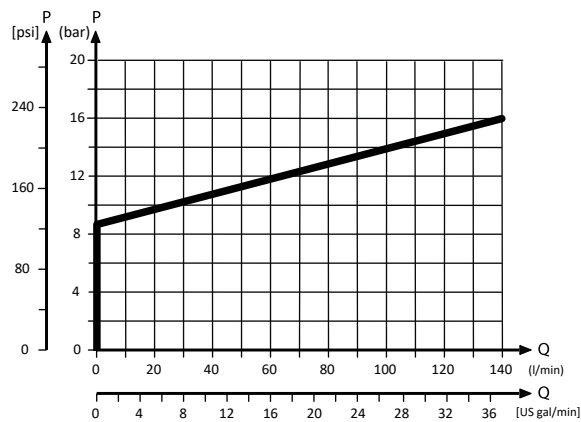
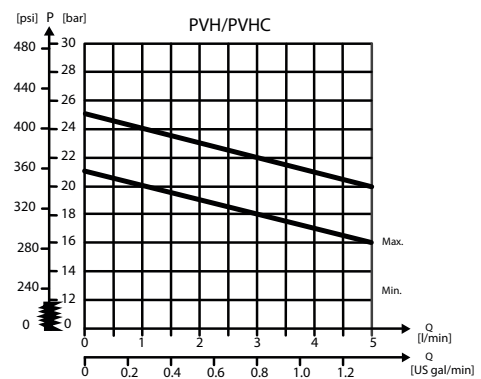
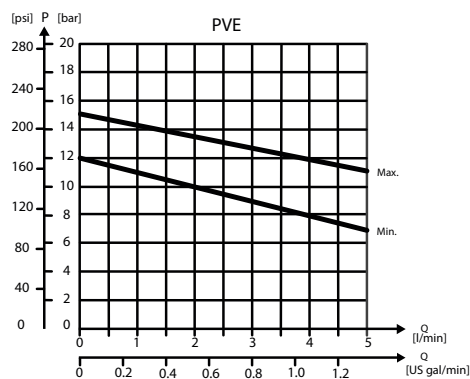
Parameter	Minimum	Recommended range	Maximum
Fluid temperature	-30°C [-22°F]	30 to 60°C [86 to 140°F]	90° [194°F]
Fluid viscosity	4 mm ² /s [39 SUS]	12 to 75 mm ² /s [65 to 347 SUS]	460 mm ² /s [2128 SUS]
Fluid cleanliness (mechanical activation)	23/19/16 (according to ISO 4406)		
Fluid cleanliness (PVE activation)	18/16/13 (according to ISO 4406)		
Operating temperature	Ambient: -30 to 60°C [-22 to 140°F]		

Technical Information
PVG 16 Proportional Valve Group
PVP Inlet Modules
Theoretical Performance Graphs
Integrated LS pressure relief valve characteristics

Neutral by-pass pressure drop characteristics

Pilot pressure reduction valve characteristics

Technical Information

PVG 16 Proportional Valve Group

PVP Inlet Modules*Part numbers for Open/Closed Center PVP with PPRV*

Part number	Actuation	P-port	T-port	LS-port (LS1 ^{**})	M-port	T0-port	Mounting	LS Boost
11093273	PVE	G3/4	G3/4	-	G1/4	-	M8	Yes
11119094	PVE	G3/4	G3/4	-	G1/4	-	M8	-
11119095	PVE	1 1/16-12 UNF	1 1/16-12 UNF	1/2-20 UNF	1/2-20 UNF	-	M8	-
11131344	PVH/PVHC	G3/4	G3/4	-	G1/4	-	M8	Yes
11168608 ¹	PVE	G3/4	G3/4	-	G1/4	-	M8	Yes

^{**} LS1 is an extra LS-port¹ Dampened LS response

All modules can be manually activated with the PVM actuation.

PVP Inlet Modules
Open/Closed center PVPM

The Open Center/Closed Center PVPM mid-inlet acts as a simple manifold and is intended for use with fixed or variable displacement pumps. The PVPM features no logic other than a PVLP shock/anti-cavitation valve facility for pressure peak protection and anti-cavitation prevention.

The PVPM module must be configured together with an Open Center PVP module for **fixed displacement pumps** and for **variable displacement pumps** can be configured together with a PVSI start plate or a Closed Center PVP/PVPV module.

The Open center/closed center PVPM features:

- Integrated shock/anti-cavitation valve facility (PVLP)
- Threaded ports for P/T
- Pilot pressure and T0 lines through module

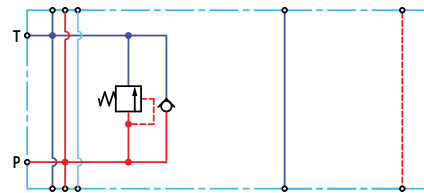
Hydraulic schematic

Technical specification for PVP

Max. P-port continuous	Max. P-port intermittent	Max. T-port static/dynamic	Max. rated flow
350 [5076 psi]	400 bar [5800 psi]	25/40 bar [365/580 psi]	230 l/min [61 US gal/min]

Technical specification

Parameter	Minimum	Recommended range	Maximum
Fluid temperature	-30°C [-22°F]	30 to 60°C [86 to 140°F]	90° [194°F]
Fluid viscosity	4 mm ² /s [39 SUS]	12 to 75 mm ² /s [65 to 347 SUS]	460 mm ² /s [2128 SUS]
Fluid cleanliness (mechanical activation)	23/19/16 (according to ISO 4406)		
Fluid cleanliness (PVE activation)	18/16/13 (according to ISO 4406)		
Operating temperature	Ambient: -30 to 60°C [-22 to 140°F]		

Part numbers for Open Center/Closed Center PVPM

Part number	P-, T-port	Mounting	PVLP
11093682	1 5/16-12 UN	5/16-18 UNC	Yes
11093684	G1"	M8	Yes

PVP Inlet Module Accessories

The generic PVP inlet module accessory platform includes the PVPX Electrical LS pressure unloading valve, External pilot pressure adapters PVPC with or without check valve for all Open Center PVP with PPRV.

- [PVPX Electrical LS Pressure Unloading Valve](#) on page 34
- [PVPC without Check Valve](#) on page 37
- [PVPC with Check Valve](#) on page 39

PVPX Electrical LS Pressure Unloading Valve

The electrical LS pressure unloading valve is an accessory available for PVP inlet modules with PVPX facility. The PVPX consist of a solenoid valve and a magnetic coil package, allowing the operator to relieve the LS pressure to tank electrically.

Configuration variants also feature a Manual Override functionality to activate the PVPX manually:

- Normally Open (NO),
- Normally Open with Manual Override (NOMO)

There are two types of NOMO-configurations - PUSH, and PUSH & TURN. With the TURN function you can keep the override function until you unlock it again.

- Normally Closed (NC)

Configuration variants

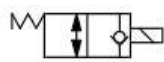
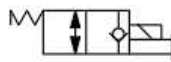
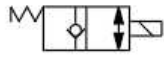
Normally Open (NO)	Normally Open with MOR (NOMO)	Normally Closed (NC)
		

Relieving the LS pressure to tank results in a reduced system pressure level, which is determined by:

- the sum of the tank and neutral by-pass pressure drop in a **Open Center** PVP configuration
- the sum of the tank and standby-pressure in a **Closed Center** PVP configuration

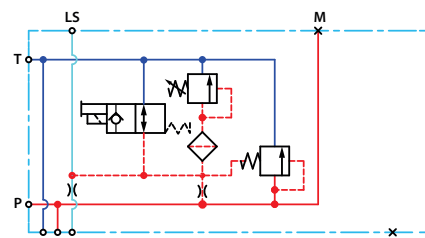
PVPX with NOMO schematic

PVPX technical data

Voltage supply	12/24 V _{DC} ± 10%
Resistance @ 12 V_{DC}	7.2 Ω ± 7%
Resistance @ 24 V_{DC}	28.2 Ω ± 7%
Power consumption	20 W
Maximum LS response time	300 ms
Max. pressure drop @ 0.1 l/min [2.6 US gal/min]	2 bar [30 psi]

PVP Inlet Module Accessories
PVPX technical data (continued)

Max. coil surface temperature	155°C [311°F]
Thread size	3/4-16 UNF

Technical specification

Parameter	Minimum	Recommended range	Maximum
Fluid temperature	-30°C [-22°F]	30 to 60°C [86 to 140°F]	90° [194°F]
Fluid viscosity	4 mm ² /s [39 SUS]	12 to 75 mm ² /s [65 to 347 SUS]	460 mm ² /s [2128 SUS]
Fluid cleanliness (mechanical activation)	23/19/16 (according to ISO 4406)		
Fluid cleanliness (PVE activation)	18/16/13 (according to ISO 4406)		
Operating temperature	Ambient: -30 to 60°C [-22 to 140°F]		

Part numbers for PVPX
Part numbers for PVPX, NO and NC configuration

Part number	Configuration	Voltage Supply	Connector	IP Rating
157B4236	NO	12 V _{DC}	1x2 DIN	IP 65
157B4238	NO	24 V _{DC}		
157B4246	NC	12 V _{DC}		
157B4248	NC	24 V _{DC}		
157B4976	NC	26 V _{DC}		
157B4981	NO	12 V _{DC}	1x2 AMP	IP 66
157B4982	NO	24 V _{DC}		
157B4983	NC	12 V _{DC}		
157B4984	NC	24 V _{DC}		
11180766	NO	12 V _{DC}	1x2 DEUTSCH	IP 67
11180767	NO	24 V _{DC}		
11180768	NC	12 V _{DC}		
11180769	NC	24 V _{DC}		
11225108	NO	26 V _{DC}		
11225109	NC	26 V _{DC}		

Part numbers for PVPX, NOMO configuration

Part number	Manual Override	Voltage Supply	Connector	IP Rating
157B4256	PUSH	12 V _{DC}	1x2 DIN	IP 65
157B4257	PUSH & TURN	12 V _{DC}		
157B4258	PUSH	24 V _{DC}		
157B4259	PUSH & TURN	24 V _{DC}		
157B4260	PUSH	26 V _{DC}		

PVP Inlet Module Accessories

Part numbers for PVPX, NOMO configuration (continued)

Part number	Manual Override	Voltage Supply	Connector	IP Rating
157B4985	PUSH	12 V _{DC}	1x2 AMP	IP 66
157B4986	PUSH	24 V _{DC}		
11193839	PUSH	12 V _{DC}	1x2 DEUTSCH	IP 67
11193836	PUSH	24 V _{DC}		
11225111	PUSH	26 V _{DC}		
11225110	PUSH & TURN			

Part number for plug in PVPX port

Part number	Description
157B5601	Plug

PVP Inlet Module Accessories
PVPC without Check Valve

The PVPC external pilot pressure adapter without check valve is an accessory in the M-port available for PVP inlet modules with integrated pilot pressure reduction valve (PPRV).

The PVPC without check valve cuts off the integrated PPRV to the PVE or PVH/PVHC in the valve group and enables an external pilot pressure supply through the PVPC adapter.

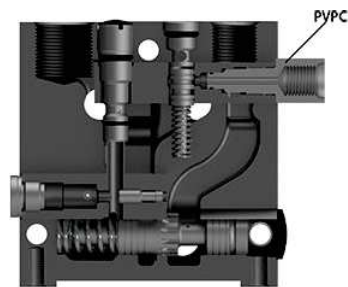
PVPC without Check Valve

One application example for the PVPC without check valve is where it is a wanted feature to supply the valve group with oil from a manually operated emergency pump without directing oil flow to the PPRV.

When the main pump is running in its normal operation mode, the oil is directed through the PVPC adapter via the PPRV to the PVE electrical actuators.

When the main pump flow fails, the external shuttle valve ensures that the oil flow from the manually operated emergency pump is used to pilot open the over-center valve and lower the load. The load is only possible to lower when using the mechanical operating lever of the PVG work sections.

Part numbers for Open Center/Closed Center PVPM

Part number	157B5400
Thread	G1/4"

Technical Information

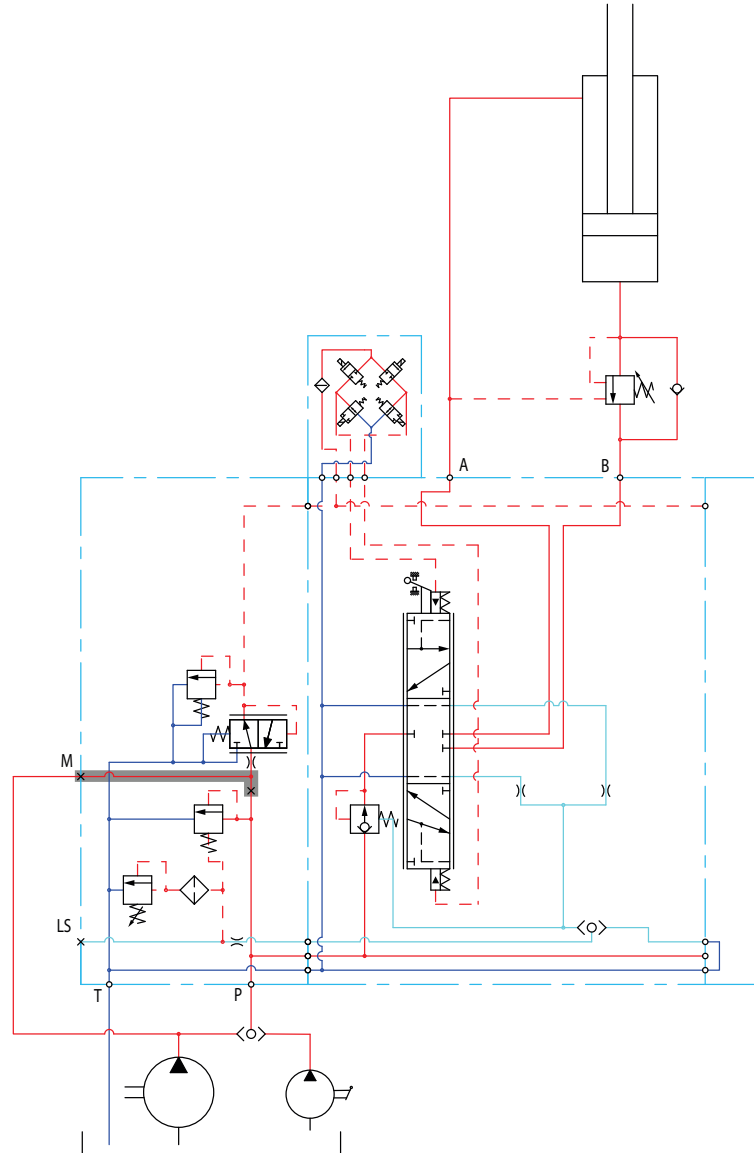
PVG 16 Proportional Valve Group**PVP Inlet Module Accessories***Hydraulic diagram for PVPC without check valve*

PVP Inlet Module Accessories
PVPC with Check Valve

The PVPC external pilot pressure adapter with check valve is an accessory in the M-port available for PVP inlet modules with integrated pilot pressure reduction valve (PPRV).

The PVPC with check valve enables an external pilot pressure supply through the PVPC adapter and the PPRV, while also allowing the main pump to supply the PPRV through the P-gallery as a standard Open Center PVP with PPRV.

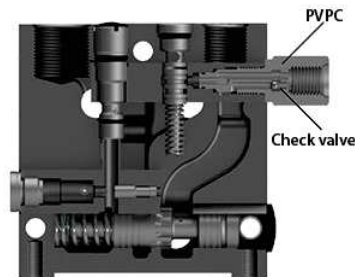
PVPC with Check Valve

One application example for the PVPC with check valve is where it is a wanted feature to operate the valve group by means of the PVE electrical actuators without pump flow.

When the external solenoid valve is opened, oil from the pressure side of the cylinder is fed via the PVPC through the PPRV to act as the pilot supply for the PVE electrical actuators. This means that it is possible to lower a load by means of the PVE electrical actuators without starting the pump.

The built-in check valve prevents the oil from flowing via the pressure adjustment spool to tank. With the pump functioning normally the external solenoid valve is closed to ensure that the load is not lowered due to the pilot supply oil flow requirement of approximately 1 l/min [0.25 US gal/min].

With a Closed Center PVP the external pilot oil supply can be connected to the pressure gauge connection without the use of a PVPC plug.

Part numbers for Open Center/Closed Center PVPM

Part number	157B5600	157B5700
Thread	G1/2"	1/2-20 UNF

Technical Information

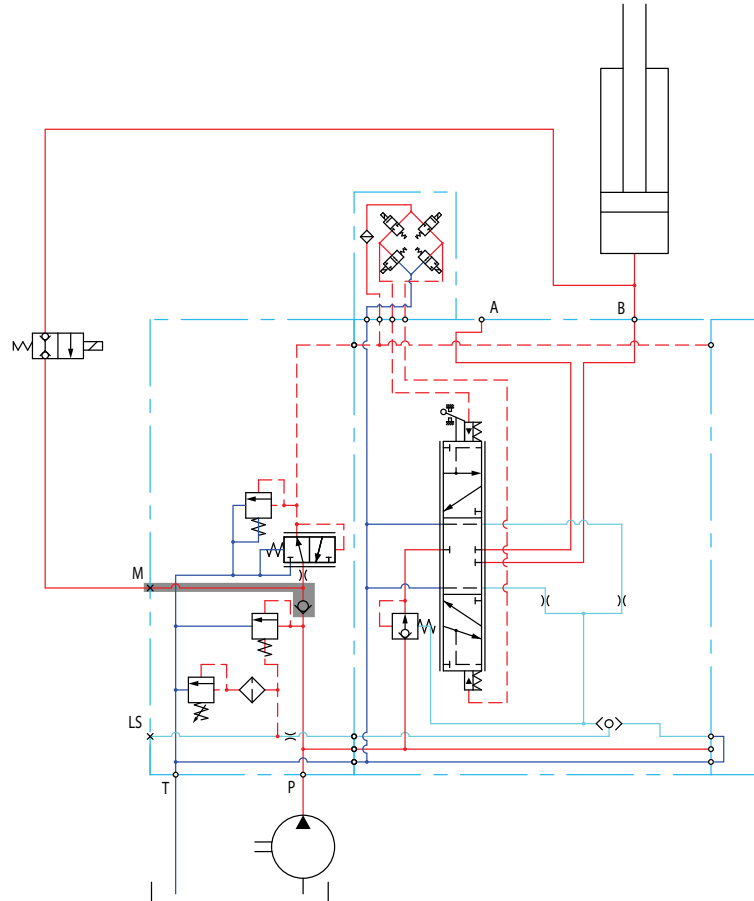
PVG 16 Proportional Valve Group**PVP Inlet Module Accessories***Hydraulic diagram for PVPC with check valve*

PVB Basic Modules

The PVG 16 PVB basic modules, also referred to as work sections, are the interface between the PVG 16 proportional valve group and the work function such as a cylinder or a motor.

PVB Basic Module

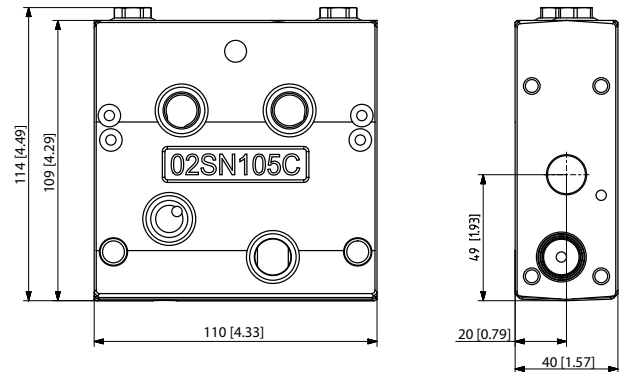
PVB 16 dimensions

Weight: 2,6 kg [5,7 lb]

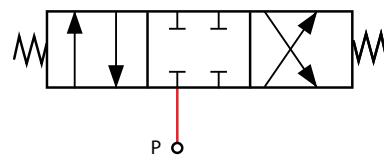
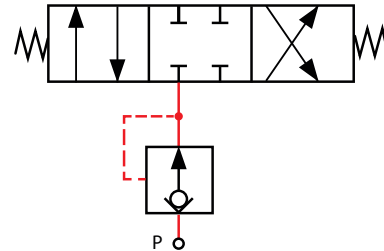
Uncompensated PVB schematic symbol

Compensated PVB schematic symbol

The PVB basic module variants are based on a generic platform with a selection of additional features, enabling you to tailor the PVB to suit the demands of any hydraulic system. The generic PVB basic module platform includes the following main variants:

- Compensated basic module; [Compensated PVB](#) on page 42
- Compensated basic module with facilities for shock and anti-cavitation valves (PVL/PVLA); [Compensated PVB with PVL/PVLA](#) on page 45
- Compensated basic module with one common adjustable LS valve for port A and port B; [Compensated PVB with LS A/B](#) on page 49
- Uncompensated basic module with optional integrated load drop check valve; [Uncompensated PVB](#) on page 52
- Uncompensated basic module with facilities for shock valves (PVL) and optional integrated load drop check valve; [Uncompensated PVB with PVL](#) on page 54

PVB Basic Modules
Compensated PVB

The compensated PVB is intended for controlling a work function where the function behavior in terms of flow and pressures requires independence on the load pressure of other functions used simultaneously.

The Compensated PVB features:

- Integrated LS shuttle network
- Integrated compensator

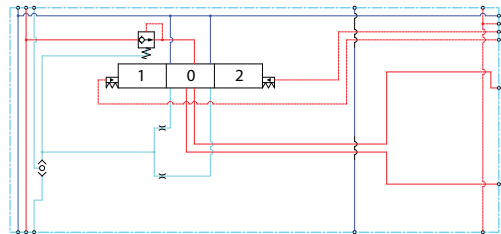
Compensated PVB schematic

Technical specification for A/B-port

Max. continuous pressure	Max. intermittent pressure	Max. rated flow
350 bar [5067 psi]	420 bar [6090 psi]	60 l/min [15 US gal/min]

Technical specification

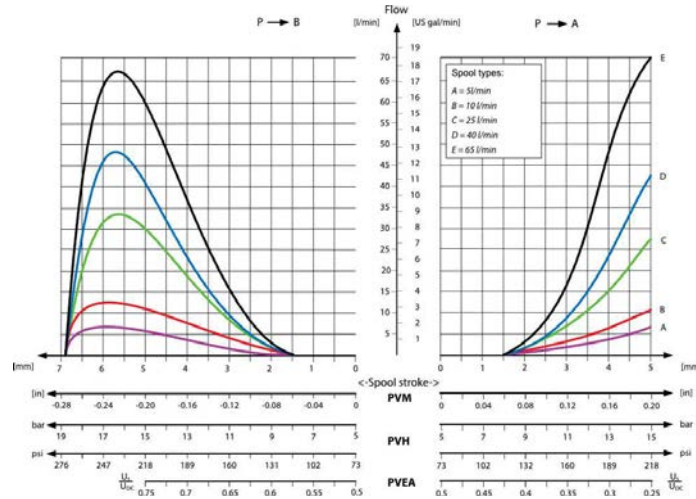
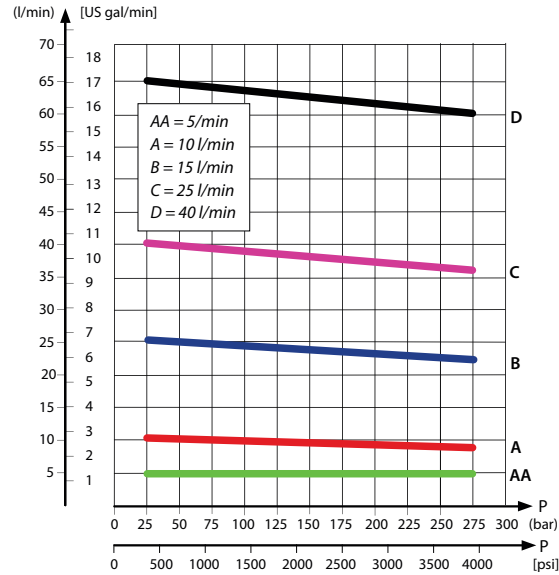
Parameter	Minimum	Recommended range	Maximum
Fluid temperature	-30°C [-22°F]	30 to 60°C [86 to 140°F]	90° [194°F]
Fluid viscosity	4 mm ² /s [39 SUS]	12 to 75 mm ² /s [65 to 347 SUS]	460 mm ² /s [2128 SUS]
Fluid cleanliness (mechanical activation)	23/19/16 (according to ISO 4406)		
Fluid cleanliness (PVE activation)	18/16/13 (according to ISO 4406)		
Operating temperature	Ambient: -30 to 60°C [-22 to 140°F]		

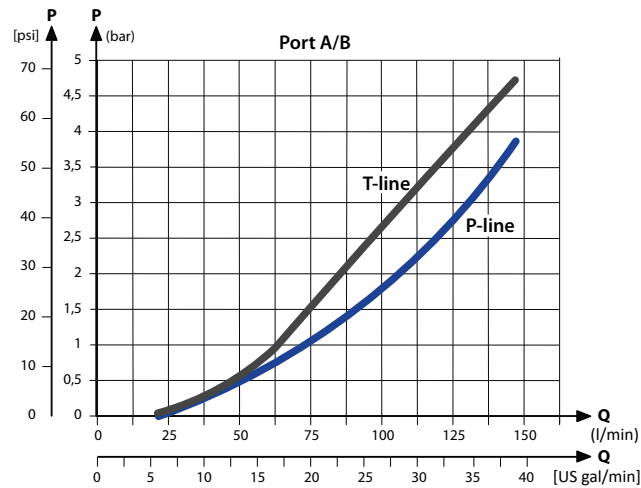
Technical Information
PVG 16 Proportional Valve Group
PVB Basic Modules
Performance graphs (Theoretical)
Fluid flow as a function of spool travel - compensated PVB

Load Independent Fluid Flow – Pressure Compensated PVB

PVB Basic Modules
PVB pressure compensated P-line and T-line characteristics

Part numbers for compensated PVB

Part number	A/B-port
11130976	3/8" BSP
11130977	3/4" - 16 UNF

PVB Basic Modules
Compensated PVB with PVLP/PVLA

The compensated PVB featuring an optional PVLP/PVLA shock and anti-cavitation valves on each work port for pressure peak protection and anti-cavitation prevention.

The compensated PVB is intended for controlling a work function where the function behavior in terms of flow and pressures requires independence on the load pressure of other functions used simultaneously.

Featuring an optional shock and anti-cavitation valves (PVLP/PVLA) on each work port for pressure peak protection and anti-cavitation prevention.

The Compensated PVB with PVLP/PVLA features:

- Integrated LS shuttle network
- Integrated compensator
- Optional shock/anti-cavitation and suction valves facility (PVLP/PVLA)

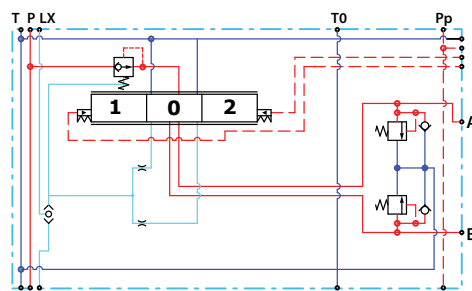
Compensated PVB with PVLP/PVLA schematic

Technical specification for A/B-port

Max. continuous pressure	Max. intermittent pressure	Max. rated flow
380 bar [5510 psi]	420 bar [6090 psi]	60 l/min [15 US gal/min]

Technical specification

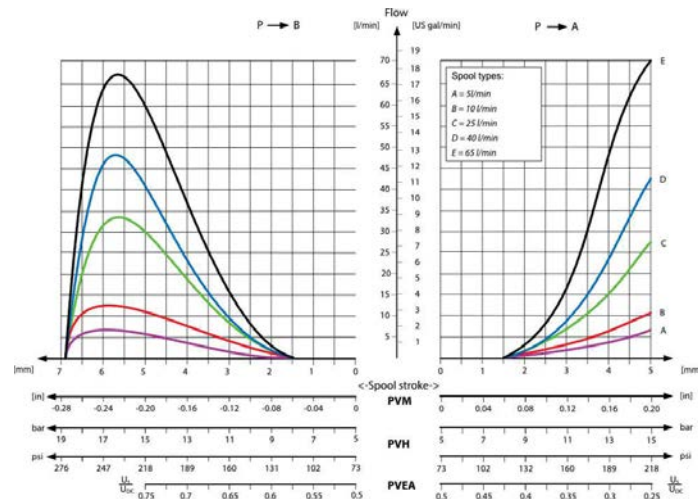
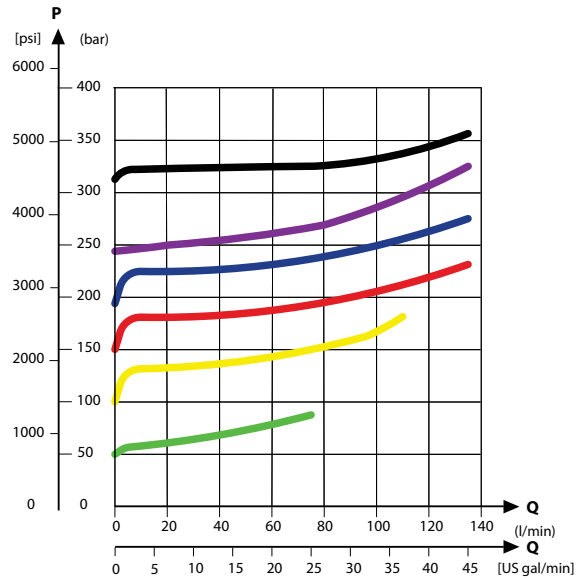
Parameter	Minimum	Recommended range	Maximum
Fluid temperature	-30°C [-22°F]	30 to 60°C [86 to 140°F]	90° [194°F]
Fluid viscosity	4 mm ² /s [39 SUS]	12 to 75 mm ² /s [65 to 347 SUS]	460 mm ² /s [2128 SUS]
Fluid cleanliness (mechanical activation)	23/19/16 (according to ISO 4406)		
Fluid cleanliness (PVE activation)	18/16/13 (according to ISO 4406)		
Operating temperature	Ambient: -30 to 60°C [-22 to 140°F]		

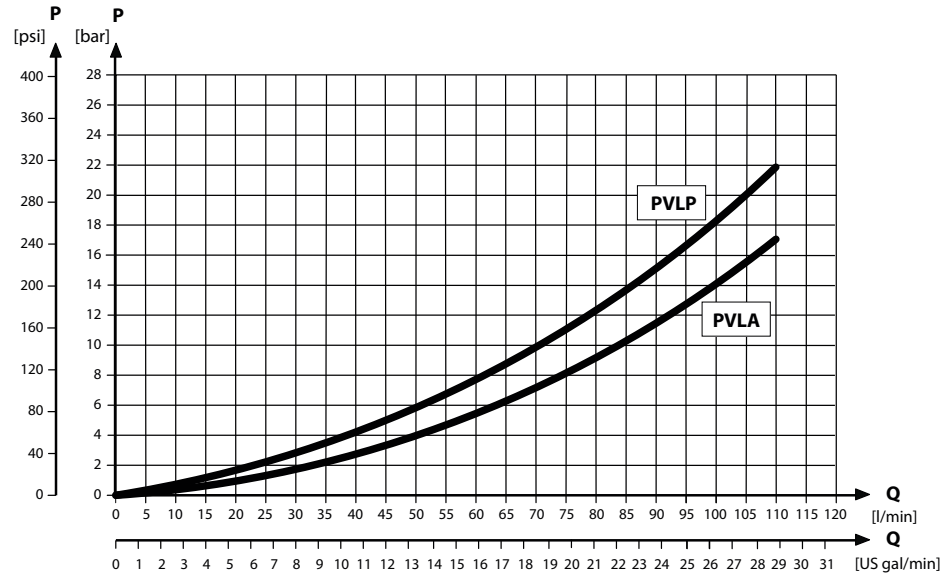
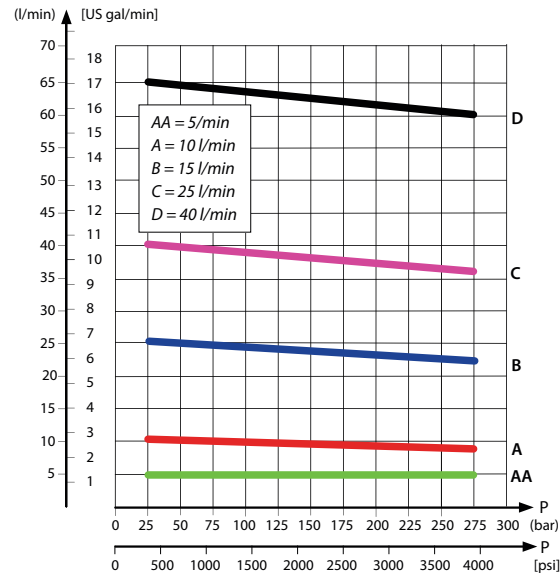
PVB Basic Modules
Performance graphs (Theoretical)
Fluid flow as a function of spool travel - compensated PVB

PVLP shock valve characteristics

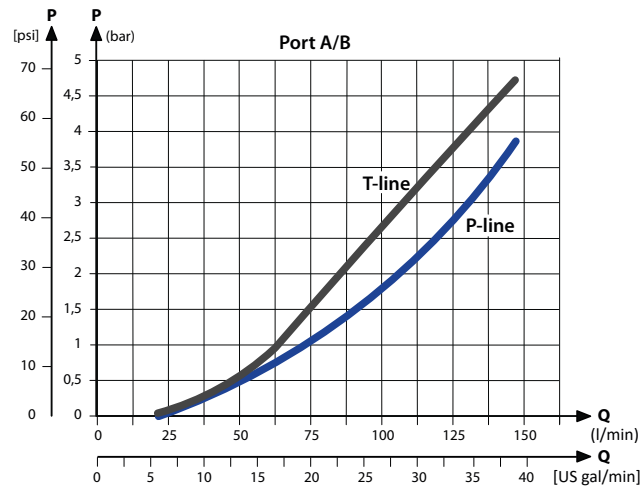
Technical Information
PVG 16 Proportional Valve Group
PVB Basic Modules
PVLP/PVLA suction valve characteristics

Load Independent Fluid Flow – Pressure Compensated PVB

PVB Basic Modules
PVB pressure compensated P-line and T-line characteristics

Part numbers for Compensated PVB with PVLP/PVLA

Part number	A/B-port	PVLP/PVLA
11130978	3/8" BSP	1
11130979	3/4" – 16 UNF	1

PVB Basic Modules
Compensated PVB with LS A/B

The compensated PVB is intended for controlling a work function where the function behavior in terms of flow and pressures requires independency on the load pressure of other functions used simultaneously. The integrated $LS_{A/B}$ relief valve is used to limit the maximum work port build-up on the A/B-ports individually.

The compensated PVB with $LS_{A/B}$ features:

- Integrated LS shuttle network
- Integrated compensator

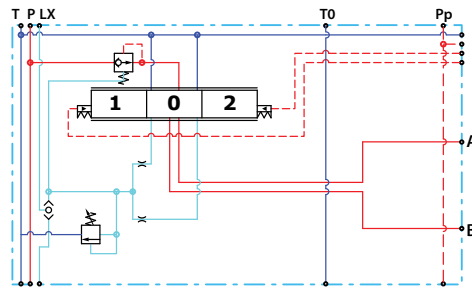
Compensated PVB with LS A/B schematic

Technical specification for A/B-port

Max. continuous pressure	Max. intermittent pressure	Max. rated flow
350 bar [5076 psi]	420 bar [6090 psi]	60 l/min [15 US gal/min]

Technical specification

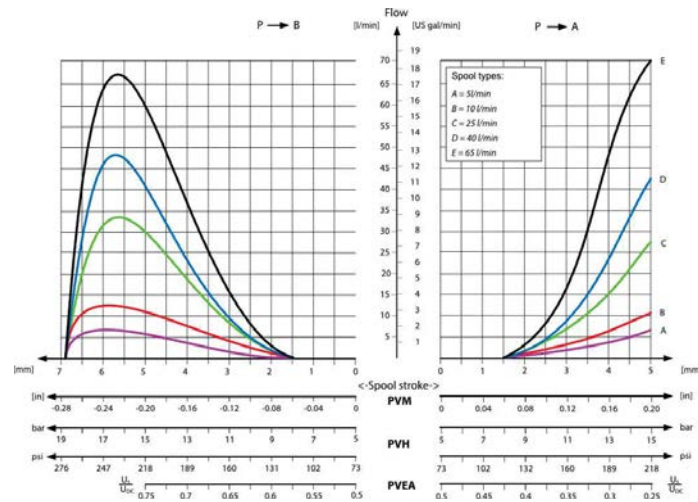
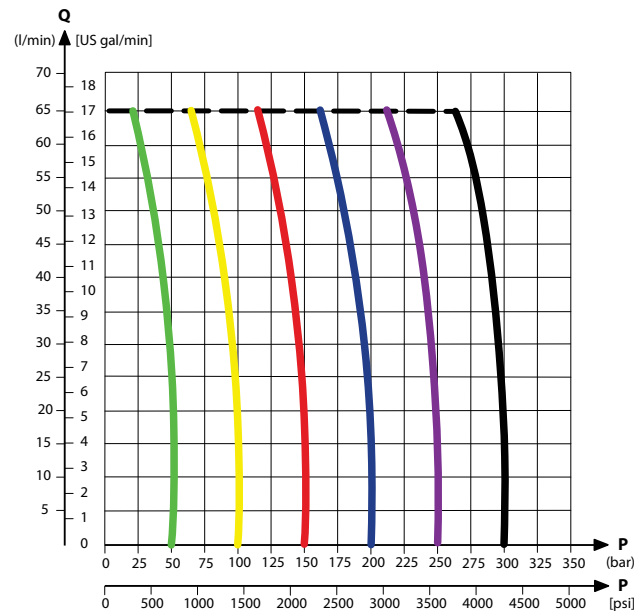
Parameter	Minimum	Recommended range	Maximum
Fluid temperature	-30°C [-22°F]	30 to 60°C [86 to 140°F]	90° [194°F]
Fluid viscosity	4 mm ² /s [39 SUS]	12 to 75 mm ² /s [65 to 347 SUS]	460 mm ² /s [2128 SUS]
Fluid cleanliness (mechanical activation)	23/19/16 (according to ISO 4406)		
Fluid cleanliness (PVE activation)	18/16/13 (according to ISO 4406)		
Operating temperature	Ambient: -30 to 60°C [-22 to 140°F]		

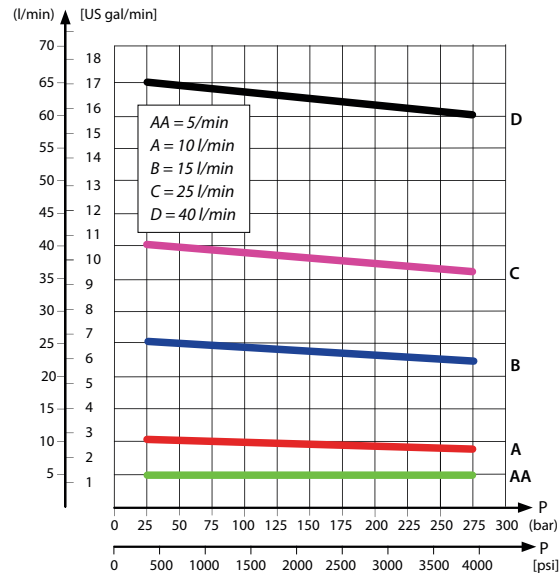
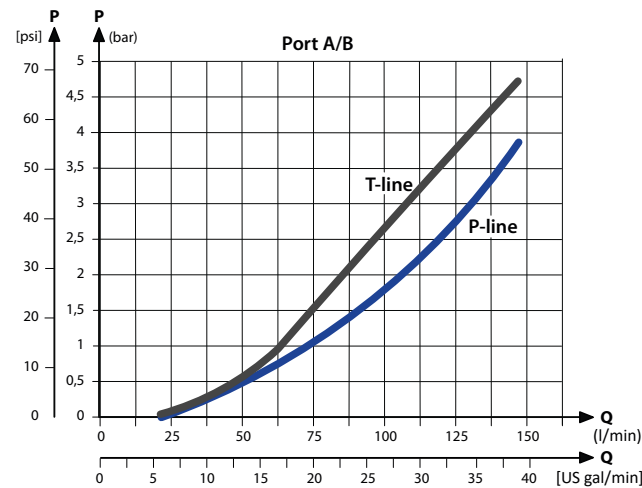
PVB Basic Modules
Performance graphs (Theoretical)
Fluid flow as a function of spool travel - compensated PVB

PVB pressure compensated for LS A/B characteristics

PVB Basic Modules
Load Independent Fluid Flow – Pressure Compensated PVB

PVB pressure compensated P-line and T-line characteristics

Part numbers for Compensated PVB with LS A/B

Part number	A/B-port
11130982	3/8" BSP
11130983	3/4" – 16 UNF

PVB Basic Modules
Uncompensated PVB

The uncompensated PVB is intended for controlling a work function where the function behavior in terms of flow and pressures requires independence on the load pressure of other functions used simultaneously.

The Uncompensated PVB features:

- Integrated LS shuttle network
- Optional load drop check valve

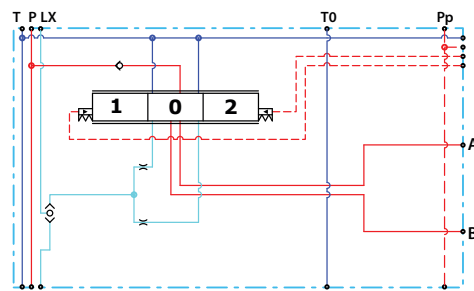
Uncompensated PVB

Technical specification for A/B-port

Max. continuous pressure	Max. intermittent pressure	Max. rated flow
380 bar [5510 psi]	420 bar [6090 psi]	65 l/min [17 US gal/min]

Technical specification

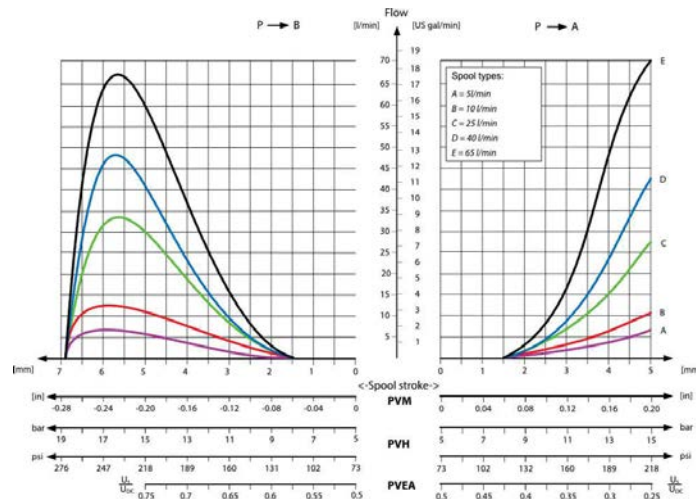
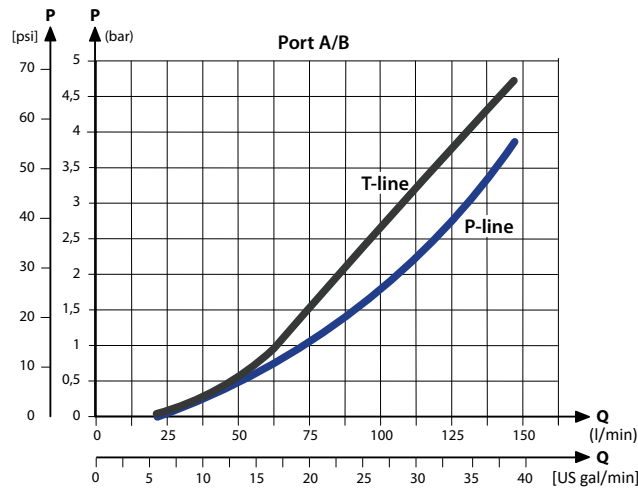
Parameter	Minimum	Recommended range	Maximum
Fluid temperature	-30°C [-22°F]	30 to 60°C [86 to 140°F]	90° [194°F]
Fluid viscosity	4 mm ² /s [39 SUS]	12 to 75 mm ² /s [65 to 347 SUS]	460 mm ² /s [2128 SUS]
Fluid cleanliness (mechanical activation)	23/19/16 (according to ISO 4406)		
Fluid cleanliness (PVE activation)	18/16/13 (according to ISO 4406)		
Operating temperature	Ambient: -30 to 60°C [-22 to 140°F]		

Technical Information
PVG 16 Proportional Valve Group
PVB Basic Modules
Performance graphs (Theoretical)
Fluid flow as a function of spool travel - compensated PVB

PVB pressure compensated P-line and T-line characteristics

Part numbers for Uncompensated PVB

Part number	A/B-port	Check valve
11106801	3/8" BSP	Yes
11101421	3/8" BSP	—
11106797	3/4" – 16 UNF	Yes
11101423	3/4" – 16 UNF	—

PVB Basic Modules
Uncompensated PVB with PVLP

The uncompensated PVB featuring an optional PVLP shock valve on each work port for pressure peak protection and anti-cavitation prevention, is intended for controlling a work function where the function behavior in terms of flow and pressures requires independence on the load pressure of other functions used simultaneously.

The Uncompensated PVB with PVLP features:

- Integrated LS shuttle network
- Optional shock valve facility (PVLP)
- Optional load drop check valve

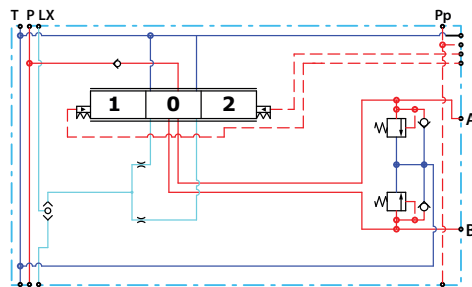
Uncompensated PVB with PVLP schematic

Technical specification for A/B-port

Max. continuous pressure	Max. intermittent pressure	Max. rated flow
380 bar [5510 psi]	420 bar [6090 psi]	65 l/min [17 US gal/min]

Technical specification

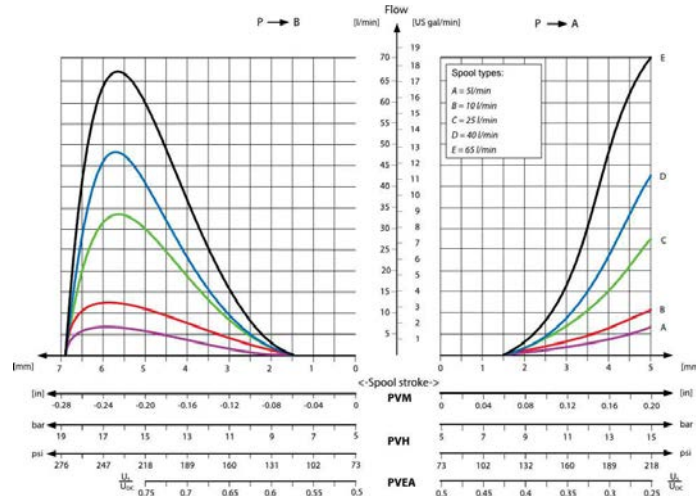
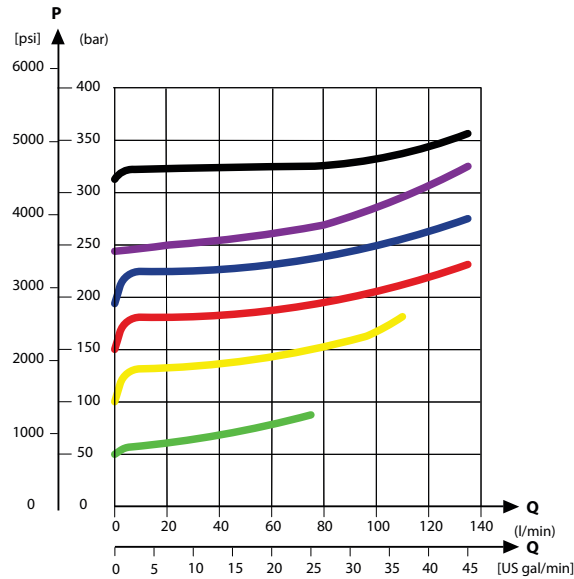
Parameter	Minimum	Recommended range	Maximum
Fluid temperature	-30°C [-22°F]	30 to 60°C [86 to 140°F]	90° [194°F]
Fluid viscosity	4 mm ² /s [39 SUS]	12 to 75 mm ² /s [65 to 347 SUS]	460 mm ² /s [2128 SUS]
Fluid cleanliness (mechanical activation)	23/19/16 (according to ISO 4406)		
Fluid cleanliness (PVE activation)	18/16/13 (according to ISO 4406)		
Operating temperature	Ambient: -30 to 60°C [-22 to 140°F]		

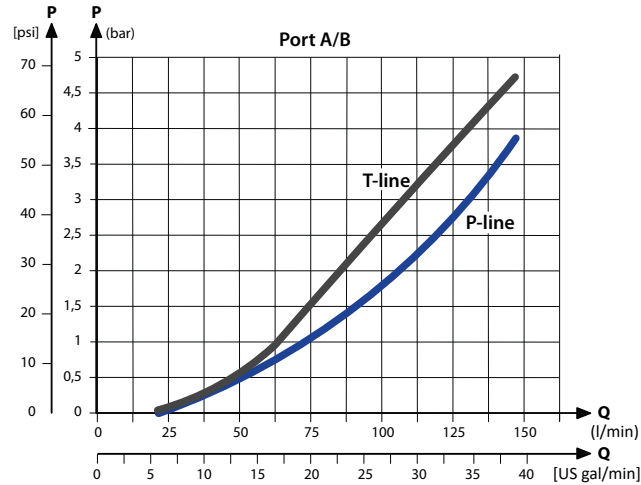
PVB Basic Modules
Performance graphs (Theoretical)
Fluid flow as a function of spool travel - compensated PVB

PVLP shock valve characteristics

PVB Basic Modules
PVB pressure compensated P-line and T-line characteristics

Part numbers for Uncompensated PVB with PVL

Part number	A/B-port	PVLP	Check valve
11101424	3/8" BSP	1	Yes
11106754	3/8" BSP	1	—
11101425	3/4" – 16 UNF	1	Yes
11106755	3/4" – 16 UNF	1	—

Technical Information
PVG 16 Proportional Valve Group
PVB Basic Modules
PVLP Shock and Anti-Cavitation Valve

The PVLP shock and anti-cavitation valve will relieve a pressure peak to the internal tank galleries and will furthermore suck oil from the tank to the work port to prevent cavitation. Pressure settings range: 32–400 bar [460–5801 psi].

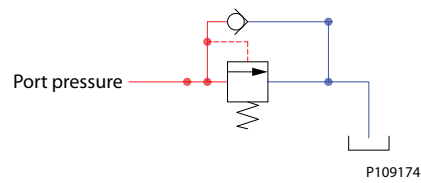
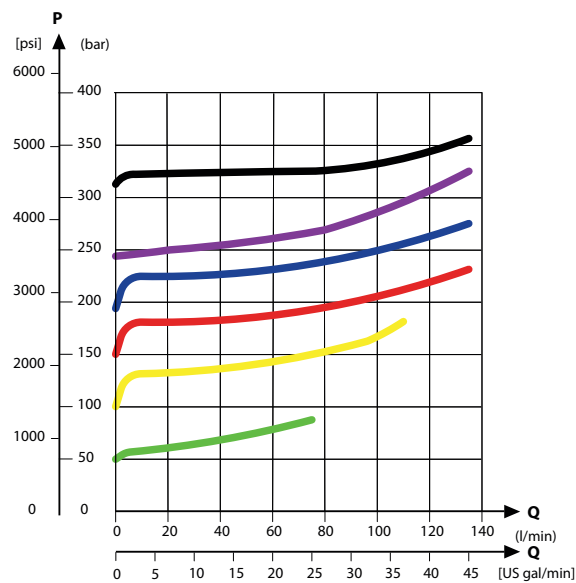
The pressure setting of the PVLP must always be 20 bar [290 psi] higher than $LS_{A/B}$ setting in the same module.

PVLP schematic

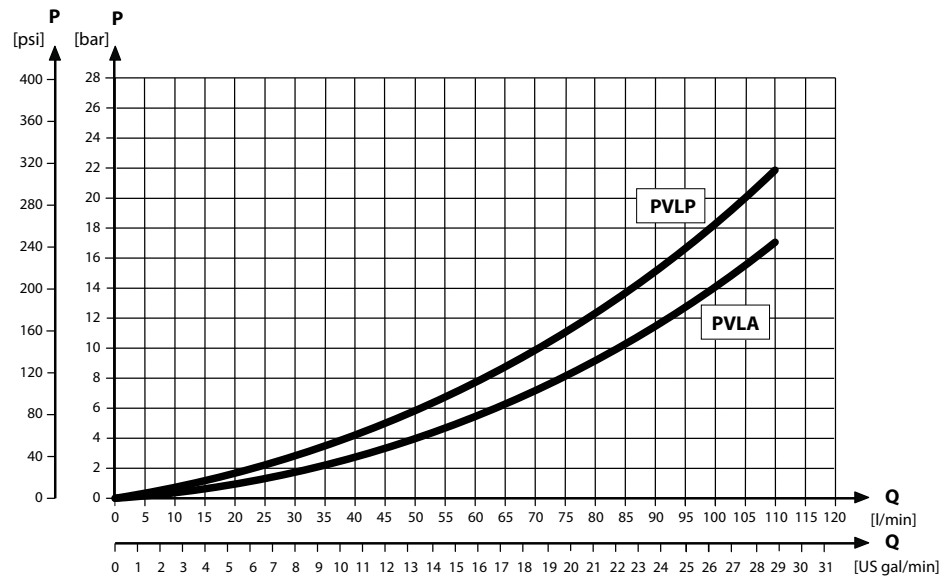
PVLP shock valve characteristics

PVB Basic Modules
PVLP/PVLA suction valve characteristics

Technical specification

Parameter	Minimum	Recommended range	Maximum
Fluid temperature	-30°C [-22°F]	30 to 60°C [86 to 140°F]	90° [194°F]
Fluid viscosity	4 mm ² /s [39 SUS]	12 to 75 mm ² /s [65 to 347 SUS]	460 mm ² /s [2128 SUS]
Fluid cleanliness (mechanical activation)	23/19/16 (according to ISO 4406)		
Fluid cleanliness (PVE activation)	18/16/13 (according to ISO 4406)		
Operating temperature	Ambient: -30 to 60°C [-22 to 140°F]		

Part numbers for PVLP according to pressure settings

Part number	Pressure in bar [psi]	Part number	Pressure in bar [psi]
157B2032	32 [464]	157B2210	210 [3045]
157B2050	50 [725]	157B2230	230 [3335]
157B2063	63 [913]	157B2240	240 [3480]
157B2080	80 [1160]	157B2250	250 [3626]
157B2100	100 [1450]	157B2265	265 [3844]
157B2125	125 [1813]	157B2280	280 [4061]
157B2140	140 [2031]	157B2300	300 [4351]
157B2150	150 [2176]	157B2320	320 [4641]
157B2160	160 [2321]	157B2350	350 [5076]
157B2175	175 [2538]	157B2380	380 [5511]
157B2190	190 [2756]		—

PVB Basic Modules Accessories

The generic PVB module accessory platform include the PVLP shock and anti-cavitation valve and PVLA suction valve.

- [PVLP Shock and Anti-Cavitation Valve](#) on page 57
- [PVLA Suction Valve](#) on page 62

PVB Basic Modules Accessories
PVLP Shock and Anti-Cavitation Valve

The PVLP shock and anti-cavitation valve will relieve a pressure peak to the internal tank galleries and will furthermore suck oil from the tank to the work port to prevent cavitation. Pressure settings range: 32–400 bar [460–5801 psi].

The pressure setting of the PVLP must always be 20 bar [290 psi] higher than $LS_{A/B}$ setting in the same module.

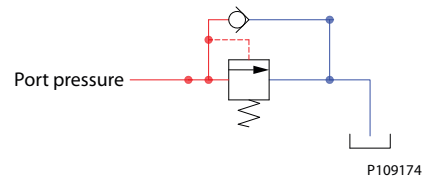
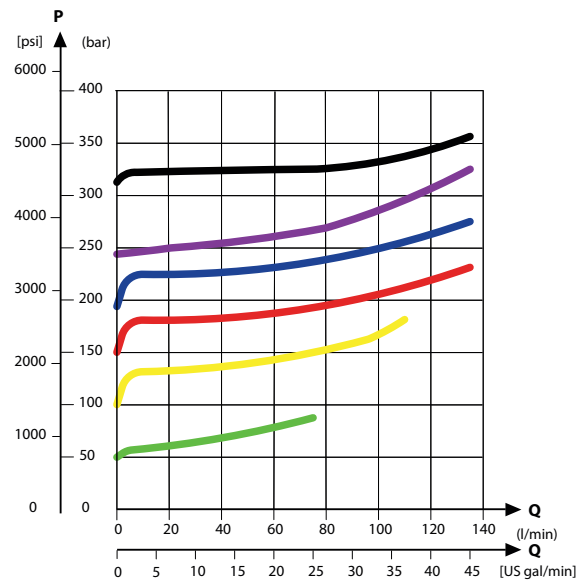
PVLP schematic

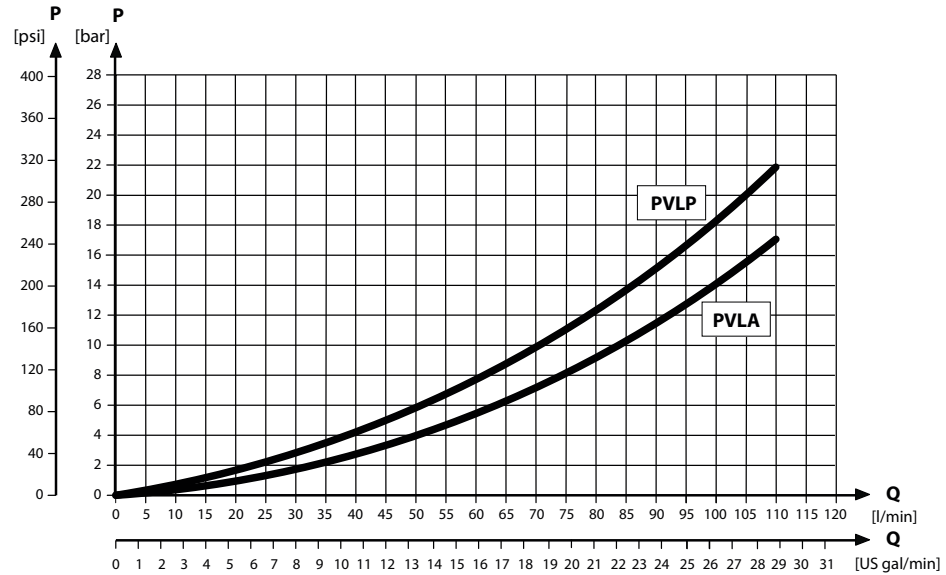
PVLP shock valve characteristics

Technical Information
PVG 16 Proportional Valve Group
PVB Basic Modules Accessories
PVLP/PVLA suction valve characteristics

Technical specification

Parameter	Minimum	Recommended range	Maximum
Fluid temperature	-30°C [-22°F]	30 to 60°C [86 to 140°F]	90° [194°F]
Fluid viscosity	4 mm ² /s [39 SUS]	12 to 75 mm ² /s [65 to 347 SUS]	460 mm ² /s [2128 SUS]
Fluid cleanliness (mechanical activation)	23/19/16 (according to ISO 4406)		
Fluid cleanliness (PVE activation)	18/16/13 (according to ISO 4406)		
Operating temperature	Ambient: -30 to 60°C [-22 to 140°F]		

Part numbers for PVLP according to pressure settings

Part number	Pressure in bar [psi]	Part number	Pressure in bar [psi]
157B2032	32 [464]	157B2210	210 [3045]
157B2050	50 [725]	157B2230	230 [3335]
157B2063	63 [913]	157B2240	240 [3480]
157B2080	80 [1160]	157B2250	250 [3626]
157B2100	100 [1450]	157B2265	265 [3844]
157B2125	125 [1813]	157B2280	280 [4061]
157B2140	140 [2031]	157B2300	300 [4351]
157B2150	150 [2176]	157B2320	320 [4641]
157B2160	160 [2321]	157B2350	350 [5076]
157B2175	175 [2538]	157B2380	380 [5511]
157B2190	190 [2756]		—

Technical Information
PVG 16 Proportional Valve Group
PVB Basic Modules Accessories
PVLA Suction Valve

The PVLA valve is an accessory available for PVB basic modules.

The PVLA will suck fluid from the tank to the work port to prevent cavitation by the 0.5 bar spring. The plug will ensure that when using a single acting spool, all flow returning through the work port is led to tank.

PVLA schematic

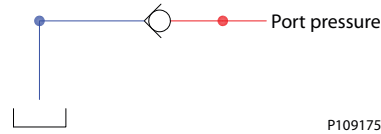

PVLP/PVLA suction valve characteristics

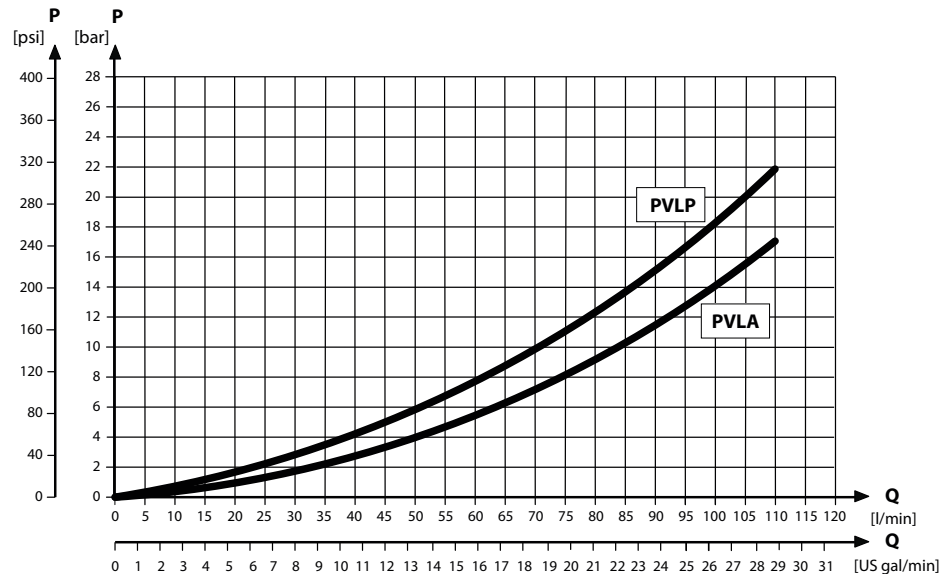

Technical specification

Parameter	Minimum	Recommended range	Maximum
Fluid temperature	-30°C [-22°F]	30 to 60°C [86 to 140°F]	90° [194°F]
Fluid viscosity	4 mm ² /s [39 SUS]	12 to 75 mm ² /s [65 to 347 SUS]	460 mm ² /s [2128 SUS]
Fluid cleanliness (mechanical activation)	23/19/16 (according to ISO 4406)		
Fluid cleanliness (PVE activation)	18/16/13 (according to ISO 4406)		
Operating temperature	Ambient: -30 to 60°C [-22 to 140°F]		

PVLA suction valve part number

PVLA suction valve	Plug
157B2001	157B2002

PVBS Main Spools

The main spools (PVBS) determine the flow out of the work section or the pressure build up and are based on a generic platform with a wide selection of additional features, enabling you to tailor the PVBS to suit the demands of any hydraulic system and any function.

The PVBS main spool can be activated in three different ways:

- Mechanically by a PVM lever
- Electrically by a PVE/PVHC actuator
- Hydraulically by a PVH actuator

PVBS main spool



PVBS main spool dimensions



Weight: 0.16 kg [0.35 lb]

General features

- 4-way, positions
- Optional 4-way, 4 positions with the right PVM
- Flow control AB
- Dead band 1.2mm [0.047 in]

PVBS Technical Parameters

Technical specification

Parameter	Minimum	Recommended range	Maximum
Fluid temperature	-30°C [-22°F]	30 to 60°C [86 to 140°F]	90° [194°F]
Fluid viscosity	4 mm ² /s [39 SUS]	12 to 75 mm ² /s [65 to 347 SUS]	460 mm ² /s [2128 SUS]
Fluid cleanliness (mechanical activation)	23/19/16 (according to ISO 4406)		
Fluid cleanliness (PVE activation)	18/16/13 (according to ISO 4406)		
Operating temperature	Ambient: -30 to 60°C [-22 to 140°F]		

PVBS Main Spools
PVBS Fluid Flow Characteristics - Theoretical Performance

Fluid flow as a function of spool travel - compensated PVB

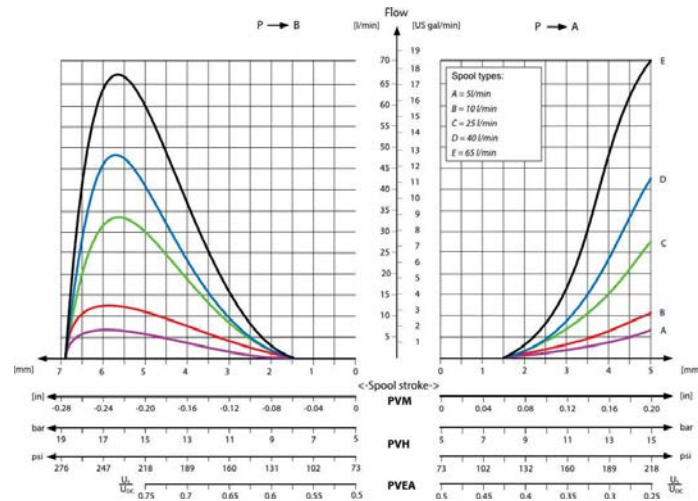

Technical Information
PVG 16 Proportional Valve Group
PVBS Main Spools

Fluid flow as a function of spool travel (asymmetrical spools)

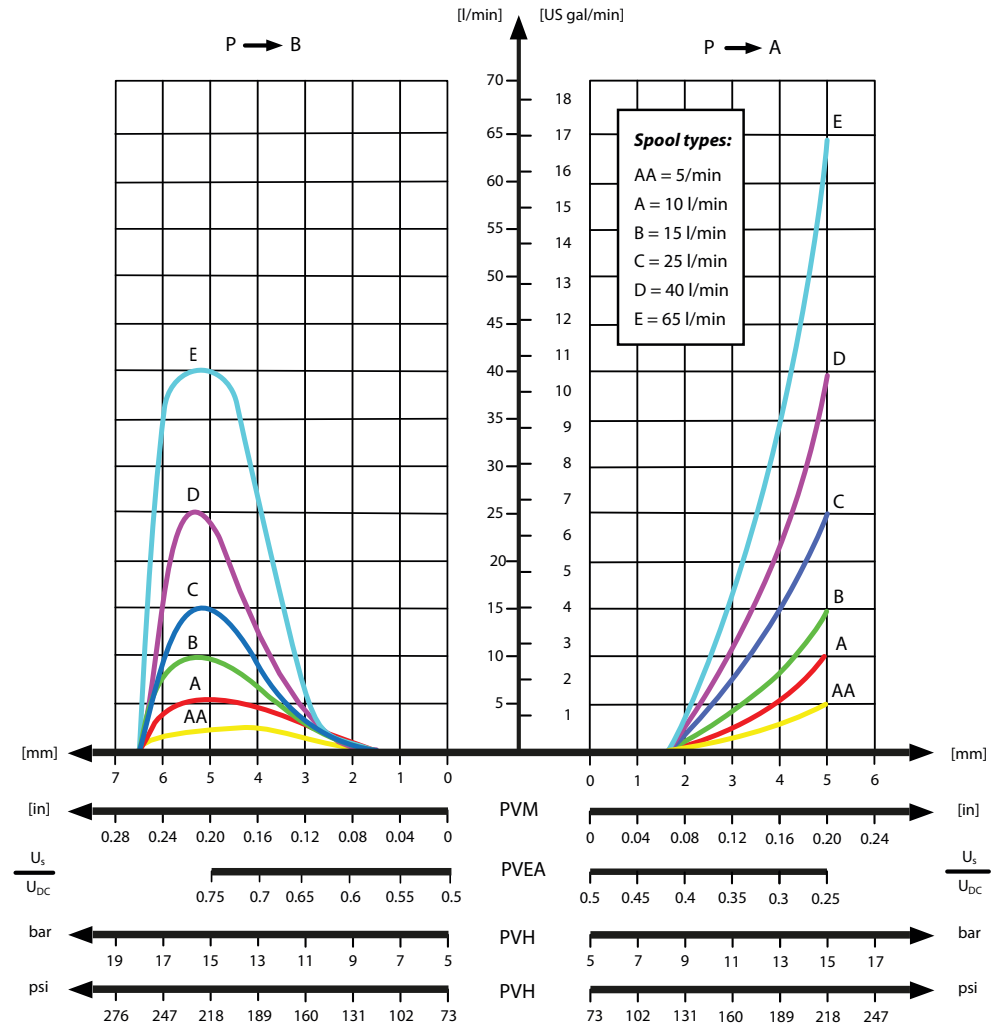

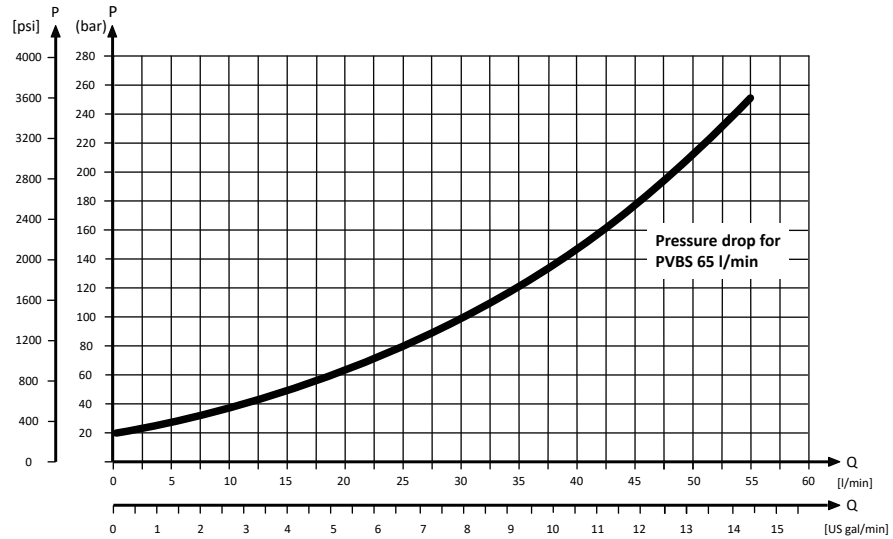
PVBS Main Spools*Pressure drop to T (open spool in neutral)*

Technical Information
PVG 16 Proportional Valve Group
PVBS Main Spools Part Numbers
Flow Control Spools - Closed Neutral Position

Schematic for PVBS - 4-way, 3 positions

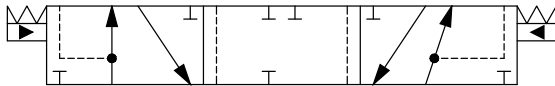

Schematic for PVBS - 4-way, 4 positions

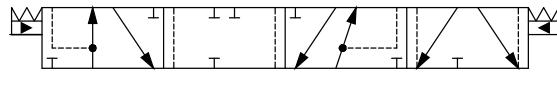
Symmetrical spools

Part number	Actuation*	Flow - l/min [US gal/min]			
		A → T	P → A	P → B	B → T
11274390	PVE	5 [1.32]	5 [1.32]	5 [1.32]	5 [1.32]
11266923	PVE	10 [2.64]	10 [2.64]	10 [2.64]	10 [2.64]
11263594	PVE	25 [6.60]	25 [6.60]	25 [6.60]	25 [6.60]
11263595	PVE	40 [10.57]	40 [10.57]	40 [10.57]	40 [10.57]
11274474	PVE	65 [17.17]	65 [17.17]	65 [17.17]	65 [17.17]
11274391	PVH/PVHC	5 [1.32]	5 [1.32]	5 [1.32]	5 [1.32]
11274477	PVH/PVHC	10 [2.64]	10 [2.64]	10 [2.64]	10 [2.64]
11274471	PVH/PVHC	25 [6.60]	25 [6.60]	25 [6.60]	25 [6.60]
11274478	PVH/PVHC	40 [10.57]	40 [10.57]	40 [10.57]	40 [10.57]
11274476	PVH/PVHC	65 [17.17]	65 [17.17]	65 [17.17]	65 [17.17]

* All spools can be mechanically actuated with a PVM, for more details see [PVM Manual Actuation](#) on page 70

Asymmetrical Spools

Part number	Actuation*	Flow - l/min [US gal/min]			
		A → T	P → A	P → B	B → T
11274479	PVE	5 [1.32]	5 [1.32]	2.5 [0.66]	2.5 [0.66]
11274493	PVE	10 [2.64]	10 [2.64]	5 [1.32]	5 [1.32]
11295455	PVE	15 [3.96]	15 [3.96]	25 [6.60]	25 [6.60]
11274495	PVE	25 [6.60]	25 [6.60]	10 [2.64]	10 [2.64]
11274496	PVE	25 [6.60]	25 [6.60]	15 [3.96]	15 [3.96]
11295456	PVE	25 [6.60]	25 [6.60]	40 [10.57]	40 [10.57]
11274497	PVE	40 [10.57]	40 [10.57]	15 [3.96]	15 [3.96]
11274480	PVH/PVHC	5 [1.32]	5 [1.32]	2.5 [0.66]	2.5 [0.66]
11295499	PVH/PVHC	10 [2.64]	10 [2.64]	5 [1.32]	5 [1.32]
11295485	PVH/PVHC	25 [6.60]	25 [6.60]	10 [2.64]	10 [2.64]
11295486	PVH/PVHC	25 [6.60]	25 [6.60]	15 [3.96]	15 [3.96]
11274487	PVH/PVHC	40 [10.57]	40 [10.57]	15 [3.96]	15 [3.96]
11295454	PVH/PVHC	40 [10.57]	40 [10.57]	25 [6.60]	25 [6.60]

* All spools can be mechanically actuated with a PVM, for more details see [PVM Manual Actuation](#) on page 70

Technical Information
PVG 16 Proportional Valve Group
PVBS Main Spools Part Numbers
Flow Control Spools - Throttled Open Neutral Position

Schematic for PVBS - 4-way, 3 positions

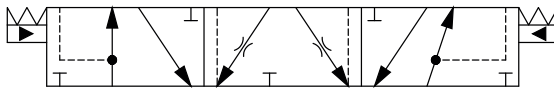

Schematic for PVBS - 4-way, 4 positions

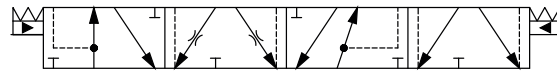

Symmetrical Spools

Part number	Actuation*	Flow – l/min [US gal/min]			
		A → T	P → A	P → B	B → T
11243966	PVE	5 [1.32]	5 [1.32]	5 [1.32]	5 [1.32]
11243967	PVE	10 [2.64]	10 [2.64]	10 [2.64]	10 [2.64]
11240624	PVE	25 [6.60]	25 [6.60]	25 [6.60]	25 [6.60]
11240625	PVE	40 [10.57]	40 [10.57]	40 [10.57]	40 [10.57]
11240632	PVE	65 [17.17]	65 [17.17]	65 [17.17]	65 [17.17]
11274482	PVH/PVHC	5 [1.32]	5 [1.32]	5 [1.32]	5 [1.32]
11274449	PVH/PVHC	10 [2.64]	10 [2.64]	10 [2.64]	10 [2.64]
11274483	PVH/PVHC	25 [6.60]	25 [6.60]	25 [6.60]	25 [6.60]
11274484	PVH/PVHC	40 [10.57]	40 [10.57]	40 [10.57]	40 [10.57]
11274467	PVH/PVHC	65 [17.17]	65 [17.17]	65 [17.17]	65 [17.17]

* All spools can be mechanically actuated with a PVM, for more details see [PVM Manual Actuation](#) on page 70

Asymmetrical Spools

Part number	Actuation*	Flow – l/min [US gal/min]			
		A → T	P → A	P → B	B → T
11295512	PVE	5 [1.32]	5 [1.32]	2.5 [0.66]	2.5 [0.66]
11295513	PVE	5 [1.32]	5 [1.32]	5 [1.32]	5 [1.32]
11295489	PVE	15 [3.96]	15 [3.96]	25 [6.60]	25 [6.60]
11295490	PVE	25 [6.60]	25 [6.60]	40 [10.57]	40 [10.57]
11309231	PVE	40 [10.57]	40 [10.57]	25 [6.60]	25 [6.60]
11295503	PVE	40 [10.57]	40 [10.57]	65 [17.17]	65 [17.17]
11295457	PVH/PVHC	15 [3.96]	15 [3.96]	25 [6.60]	25 [6.60]

* All spools can be mechanically actuated with a PVM, for more details see [PVM Manual Actuation](#) on page 70

Technical Information
PVG 16 Proportional Valve Group
PVBS Main Spools Part Numbers
Flow Control Spools - Open/Closed Neutral Position

Schematic for PVBS - 4-way, 3 positions

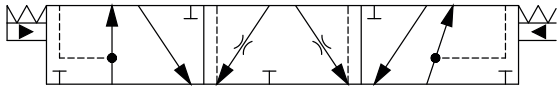

Schematic for PVBS - 4-way, 4 positions

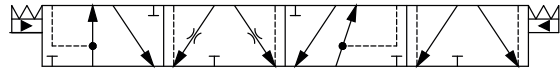
Asymmetrical Spools

Part number	Actuation*	Flow - l/min [US gal/min]			
		A → T	P → A	P → B	B → T
11179510	PVE	15 [3.96]	15 [3.96]	5 [1.32]	15 [3.96]

* All spools can be mechanically actuated with a PVM, for more details see *PVM Manual Actuation* on page 70

PVG 16 Actuation

PVG 16 actuation can be done manually, hydraulically, electro-hydraulically and electrically.

PVG 16 actuation overview:

- [PVM Manual Actuation](#) on page 70
 - [PVMD Cover](#) on page 71
- [PVH Hydraulic Actuation](#) on page 72
- [PVHC Electro-Hydraulic Actuation](#) on page 74
- [PVE Electro-hydraulic Actuation](#) on page 76
 - [PVEO](#) on page 78
 - [PVEA Series 6 Proportional Control Actuator](#) on page 81

PVM Manual Actuation

The PVM manual actuation cover is intended for use on any work section where the operator has to have the ability to interact with the spool manually.

The PVM variants are based on a generic platform with a selection of additional features, enabling you to tailor the PVM to suit the demands of any hydraulic system, which includes the following main variants:

- PVM manual actuation or override of a function
- Spring centering cover without manual override (PVML)
 - Optional with lever base
 - Optional with lever base and lever
 - Optional flow adjustment screws

The adjustment screws are intended for limiting the spool travel and thereby the maximum achievable flow.

PVM cover

PVM dimensions

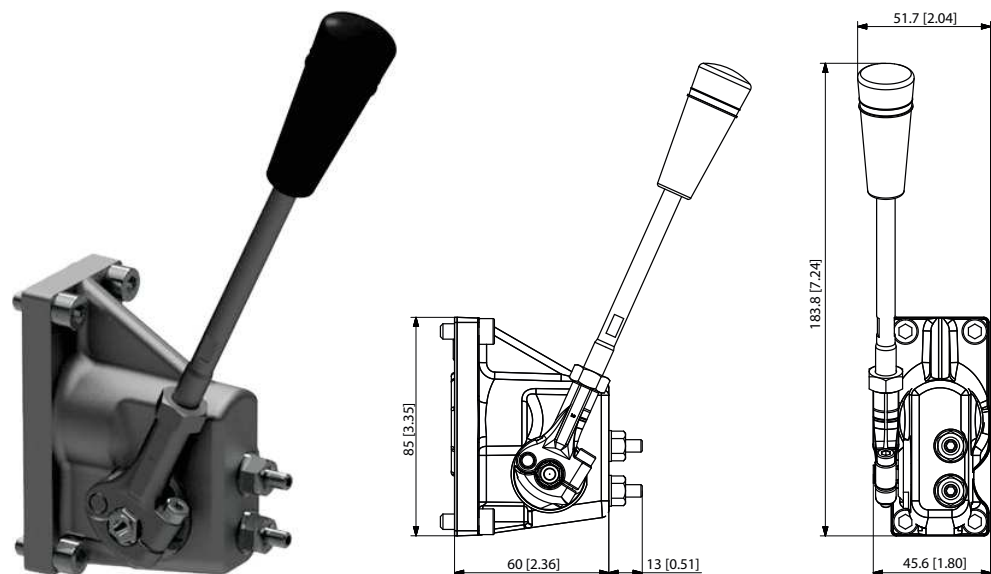

Control lever data

Standard control range	Control lever range + float position
± 13.9°	22.3°

Technical Information
PVG 16 Proportional Valve Group
PVG 16 Actuation
PVM torque data

Spool displacement	PVM+PVMD PVM+PVE	PVM+PVH
From neutral position	2.2 ± 0.2 N·m [19.5 ± 1.8 lb·in]	2.7 ± 0.2 N·m [23.9 ± 1.8 lb·in]
Max. spool travel	2.8 ± 0.2 N·m [24.8 ± 1.8 lb·in]	7.1 ± 0.2 N·m [62.8 ± 1.8 lb·in]

Part numbers for PVM Manual Actuation

Part number	Float	Adjustment screws	Lever base and lever	Weight
11107332	—	Yes	Yes	0,22 kg [0,49 lb]
11107333	—	—	Yes	
11107335	Yes	—	Yes	
11107505	—	—	—	
11107506	Yes	—	—	
11107507	—	Yes	—	

PVMD Cover

The PVMD cover is used when work section is purely mechanical activated.

PVMD Cover

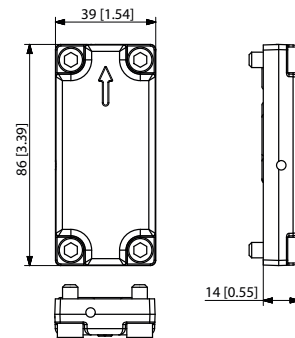
Dimensions, mm [in]

Part number and weight for PVMD Cover

Part number	11105518
Weight	1.5 kg [3.3 lb]

PVG 16 Actuation
PVH Hydraulic Actuation

The PVH hydraulic actuation is intended for use on any work section where the operator wants to have a possibility to interact with the main spool via a hydraulic joystick. The spool spring package must match with this activation method.

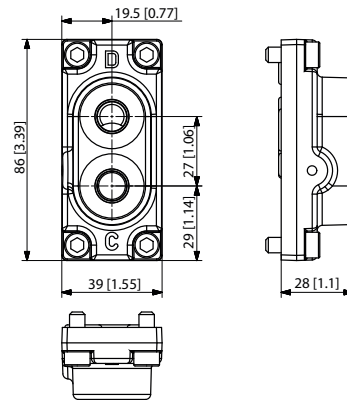
PVH cover

PVH 16 cover dimensions

The hydraulic remote control lever should be connected directly to the tank.

PVG 16 Actuation

Fluid flow as a function of spool travel - PVH

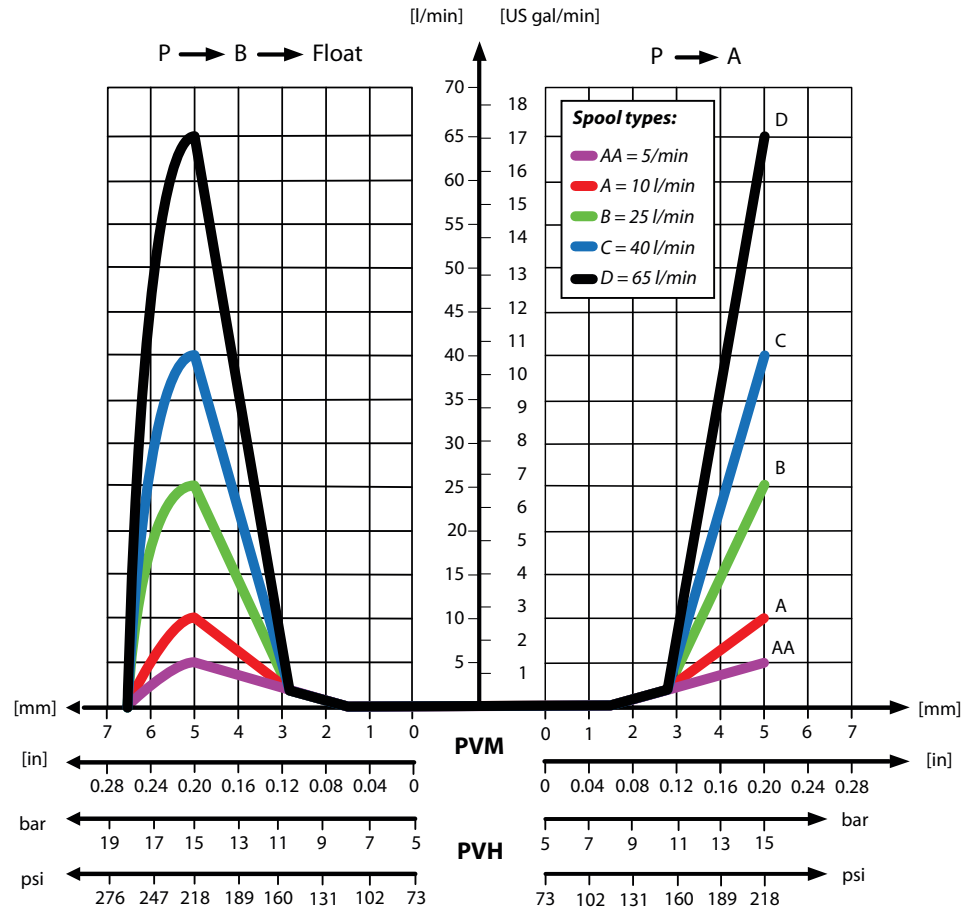

Technical data

Main spool spring control pressure range	5 – 15 bar [73 – 218 psi]
Maximum pilot oil pressure	30 bar [435 psi]
Maximum pressure on port T	10 bar [145 psi]

Part numbers for PVH Hydraulic Actuation

Part number	Material	Connection	Weight
11108380	Aluminum	G1/4" BSP	0,13 kg [0,29 lb]
11108381		9/16"-18 UNF	

PVG 16 Actuation
PVHC Electro-Hydraulic Actuation

The PVHC is an electrical actuator module for main spool control. The PVHC control is done by dual Pulse Width Modulated, high current supply 100-400 Hz PWM control signals. The spool position will shift when conditions are changed such as temperature change.

Inlet with Hydraulic Pilot Pressure is needed.

PVHC, Electro-Hydraulic Actuator



PVHC dimensions

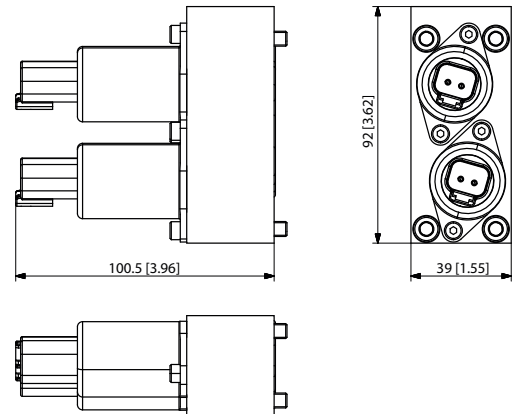

Weight: 0,9 kg [1,98 lb]

PVHC schematic

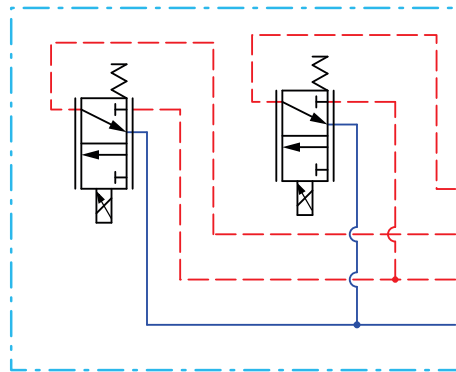

Dither frequency with a certain amplitude is needed for optimal application performance.

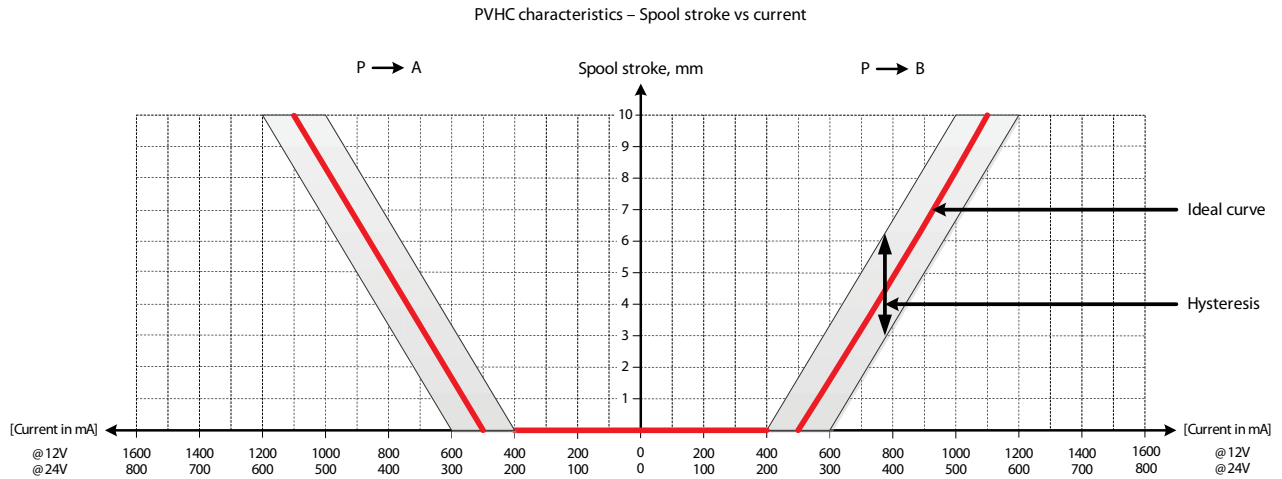
PVG 16 Actuation
PVHC spool stroke vs current characteristics

The hysteresis is affected by viscosity, friction, flow forces, dither frequency and modulation frequency.

Technical data

Supply Voltage U_{DC}	12 V _{DC}	24 V _{DC}
Current input	0 – 1500 mA	0 – 750 mA
Resistance	4.75 Ω ± 5 %	20.8 Ω ± 5 %
Response time	150 to 200 ms	
PWM frequency	100 to 400 Hz	
Recommended dither frequency	250 Hz	
Recommended dither amplitude	40 mA	
Main spool spring control pressure range	5 – 15 bar [73 – 218 psi]	
Pilot oil pressure range	20 – 25 bar [290 – 362 psi]	
Ambient temperature range	-30°C to 80°C [-22 °F to 176°F]	
Temperature range	-20°C to 80°C [-4 °F to 176°F]	
Fluid cleanliness	23/19/16 (according to ISO 4406)	

Part numbers for PVHC Actuators

Part number	Power supply	Connector type	Protection Class
11126941	12V	2x2 DEUTSCH	IP 67
11127535	24V		

PVG 16 Actuation
PVE Electro-hydraulic Actuation

The analog PVE Series 6 is an electro-hydraulic actuator used to control a single work section of a PVG proportional valve group. The PVE actuator program for PVG 16 includes variants with different performance levels and features.

The actuator positions the main spool in a PVG work section to control either the flow or the pressure of the oil distributed to and from the work function. The control signal to the actuator is an analog voltage signal, enabling the user to operate the work function remotely by means of a joystick, a controller or the similar.

The electro-hydraulic solenoid valve bridge of the actuator is available in different designs utilizing different regulation principles, depending on performance variant. The actuator positions the main spool by distributing pilot oil pressure to either side of it, pressurizing one side by pilot pressure while relieving the opposite side to tank and vice versa. All proportional actuators feature a closed-loop spool control and continuous fault monitoring.

The analog PVE Series 6 actuator program for PVG 16 features two different main hydraulic principle variants (PVEO and PVEA).

The different hydraulic principles combined with the different solenoid valve regulation principles determine whether the actuator controls the spool proportionally according to a demand signal or ON/OFF according to a voltage signal. The voltage control characteristic of the PVE actuators is shown in the figure below on the left side.

PVG 16 with PVEO sectional view

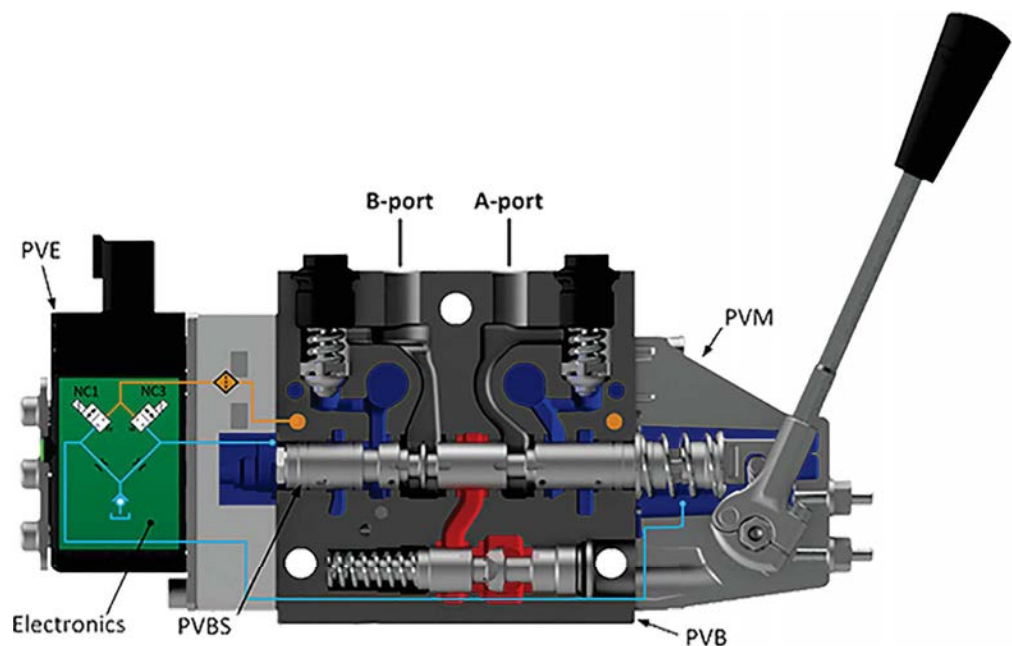

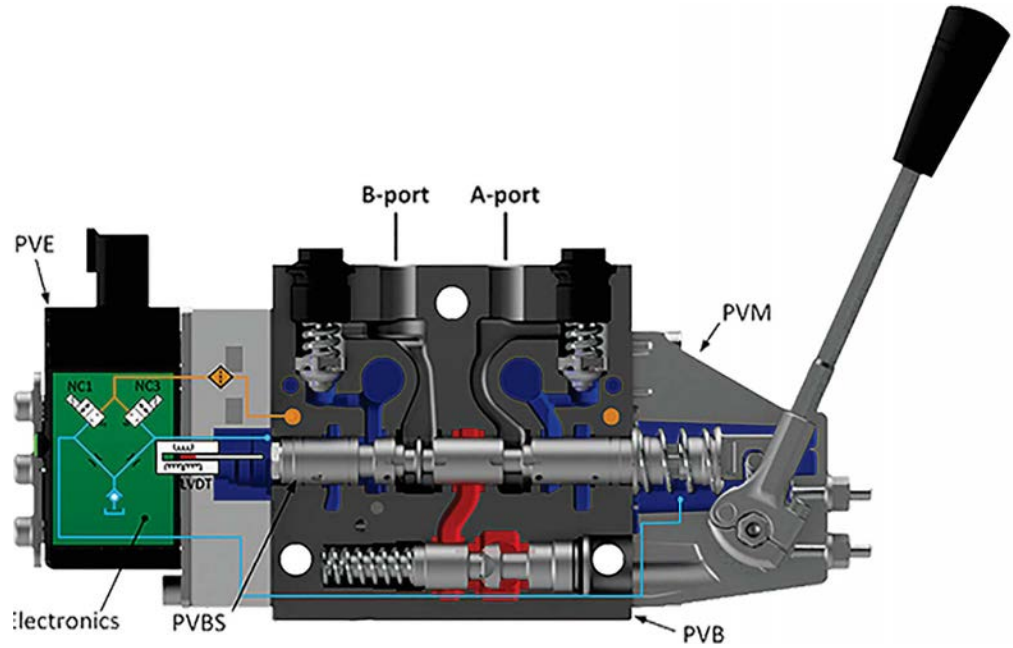

Technical Information
PVG 16 Proportional Valve Group
PVG 16 Actuation

PVG 16 with PVEA sectional view



PVE Series 6 Overview

ON/OFF voltage control, non-proportional functions	Proportional spool control for work functions
<p data-bbox="643 1249 767 1279"><i>PVEO Series 6</i></p>  <p data-bbox="496 1615 919 1637">For more information please see PVEO on page 78.</p>	<p data-bbox="1137 1249 1262 1279"><i>PVEA Series 6</i></p> 

PVG 16 Actuation
PVEO

The PVEO actuator is a non-proportional ON/OFF control actuator with open-loop spool control primarily used to control simple ON/OFF work functions where a proportional control of speed or oil flow is not a requirement.

PVEO Series 6



- Neutral position or max. spool stroke according to control signal
- 12 V_{DC} or 24 V_{DC} supply voltage
- DEUTSCH connectors
- Standard PVE pilot oil pressure of 13.5 bar [196 psi]
- LED only indicating Power ON or Power OFF
- CAN-interface (-CI)

Functionality principle

PVEO functionality diagram

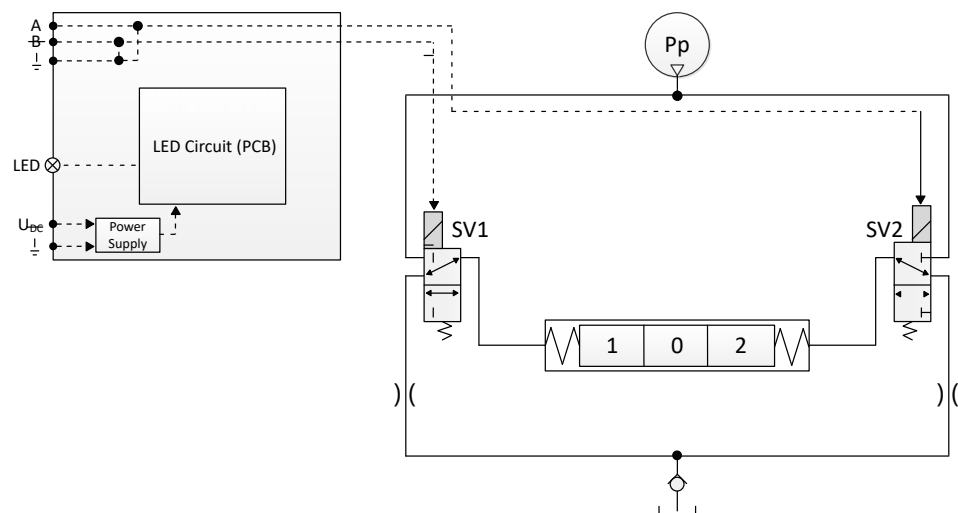

The standard PVEO functionality includes the simplest electric circuit of the PVE actuator program, using a fixed 12 V_{DC} or 24 V_{DC} supply voltage or signal voltage and a simple LED circuit to control the LED light indicating Power ON/OFF.

An energization of solenoid valve SV1 and a simultaneous de-energization of SV2 will cause the main spool to move to the right direction and vice versa. If both SV1 and SV2 are energized or de-energized simultaneously, the main spool stays locked in its neutral position.

Technical Information
PVG 16 Proportional Valve Group

PVG 16 Actuation

PVEO Series 6 schematic

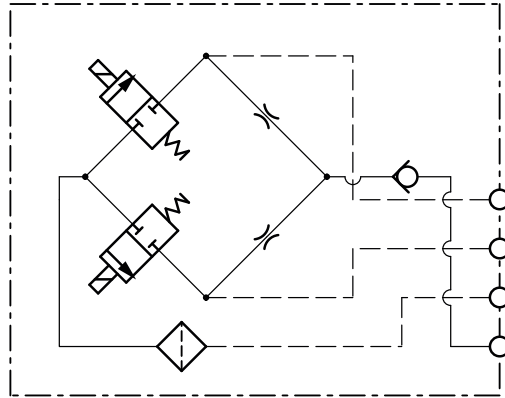

PVEO Series 6 dimensions

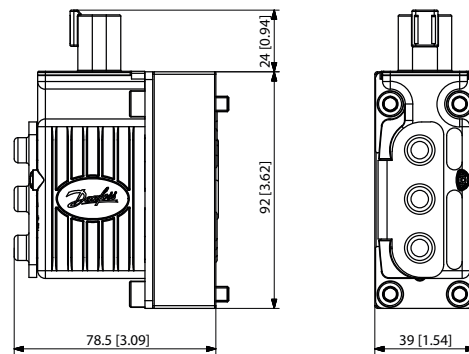

Weight: 0.7 kg [1.54 lb]

PVG 16 Actuation
PVEO Technical Data
Control Specifications

Description	Type	12 V _{DC} ± 10%	24 V _{DC} ± 10%
Supply Voltage (U _{DC})	Range	11 to 15 V _{DC}	22 to 30 V _{DC}
	Max. ripple	5%	5%
Current Consumption	Typical	320 mA	160 mA

Pilot pressure

Minimum	Nominal	Maximum
10.0 bar [145 psi]	13.5 bar [196 psi]	15.0 bar [218 psi]

Fluid consumption

Neutral/Locked position	Actuating
0.04 l/min [0.11 US gal/min]	0.6 l/min [0.16 US gal/min]

Technical specification

Parameter	Minimum	Recommended range	Maximum
Fluid viscosity	4 mm ² /s [39 SUS]	12 to 75 mm ² /s [65 to 347 SUS]	460 mm ² /s [2128 SUS]
Fluid cleanliness	18/16/13 (according to ISO 4406)		
Storage temperature	Ambient: -50 to 90°C [-58 to 194°F]		
Operating temperature	Ambient: -40 to 90°C [-40 to 194°F]		

LED characteristic

Color	LED characteristic	Description
Green constant		Power ON

PVEO/PVEO-CI reaction time

Reaction time	A-direction	B-direction
Neutral to full stroke	173 ms	105 ms
Full spool stroke to neutral	396 ms	565 ms

Part numbers for PVEO and PVEO-CI

Part number	Type	Connector	Protection Class	Voltage	Interface
11106793	PVEO	1x4 DEUTSCH	IP 67	12 V _{DC}	—
11106794	PVEO	1x4 DEUTSCH	IP 67	24 V _{DC}	—
11124002	PVEO-CI	2x4 DEUTSCH	IP 67	—	J1939/ISObus
11149443	PVEO-CI	2x4 DEUTSCH	IP 67	—	CANopen

PVG 16 Actuation
PVEA Series 6 Proportional Control Actuator

The PVEA actuator is a proportional control actuator with a closed-loop spool control primarily used to control work functions with above medium performance requirements

PVEA Series 6

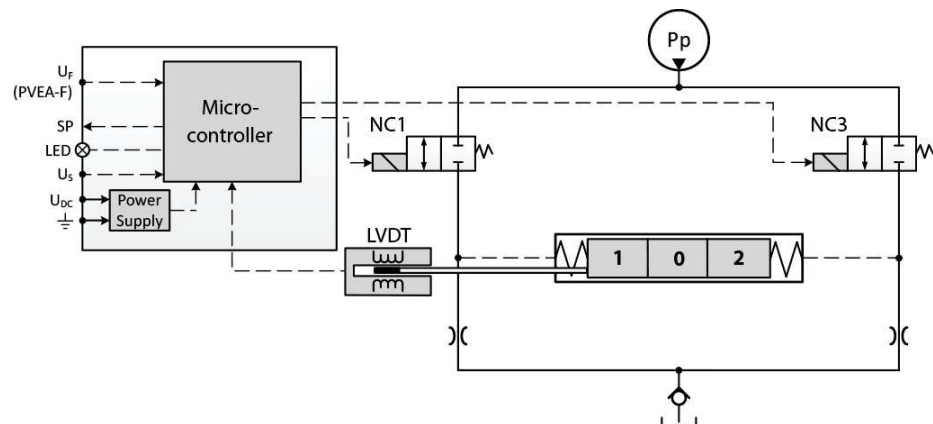

The PVEA functionality includes an electric circuit with a closed-loop logic. An integrated feedback transducer measures spool movement in relation to the input signal. The PVEA features passive fault monitoring, LED indicating fault state, error output pin and Power Save mode.

PVEA functionality

Power Save mode is entered when the command signal to the PVEA is below 15% of the supply voltage. Entering Power Save mode will turn off the power to the solenoid valves. Power Save mode can be identified by the LED blinking green at 1 Hz.

All variants available with following features:

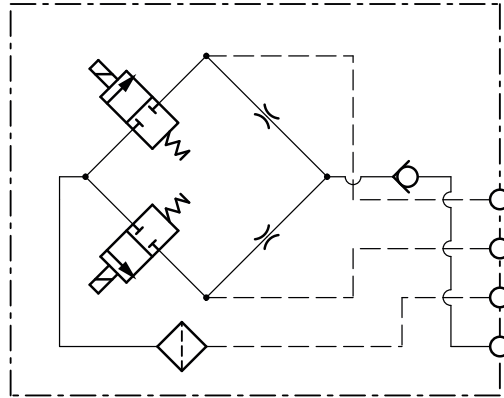
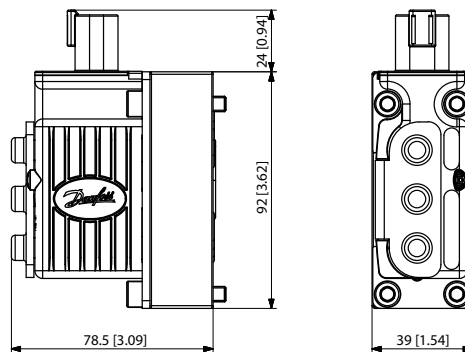
- Neutral position or max. spool stroke according to control signal
- 11–32 V_{DC} multi-voltage power supply
- DEUTSCH connectors
- Standard PVE pilot oil pressure of 13.5 bar [196 psi]
- LED indicating error state and passive fault monitoring
- Float (-F) and CAN-interface (-CI)

PVG 16 Actuation
PVEA (-F) Series 6 schematic

PVEA (-F) Series 6 dimensions

Weight: 0.7 kg [1.54 lb]

PVEA Technical Data

PVEA/PVEA-CI/PVEA-F actuator technical specification and part numbers.

Control specification

Description	Type	Value
Supply voltage (U_{DC})	Rated/range	11 to 32 V _{DC}
	Max. ripple	15 bar [218 psi]
Signal voltage (U_S)	Neutral	0.5 U _{DC}
	Q: P -> A	0.25 U _{DC}
	Q: P -> B	0.75 U _{DC}
Current consumption	@ 12 V _{DC}	320 mA
	@ 24 V _{DC}	170 mA
Input impedance	Rated	12 kΩ
Input capacitance	Rated	100 μF

Technical data

Pilot pressure	Nominal	13.5 bar [196 psi]
	Minimum	10.0 bar [145 psi]
	Maximum	15.0 bar [218 psi]

Technical Information
PVG 16 Proportional Valve Group
PVG 16 Actuation
Technical data (continued)

Fluid consumption	Neutral	0.04 l/min [0.01 US gal/min]
	Locked position	0.04 l/min [0.01 US gal/min]
	Actuating	0.6 l/min [0.16 US gal/min]
Fluid temperature	Ambient Storage	-50 to +90°C [-58 to +194°F]
	Ambient Operating	-40 to +90°C [-40 to +194°F]
Fluid viscosity	Operating range	12 to 75 mm ² /sec [65 to 347 SUS]
	Minimum	4 mm ² /sec [39 SUS]
	Maximum	460 mm ² /sec [2128 SUS]
Fluid cleanliness	Minimum	18/16/13 (according to ISO 4406)

LED characteristic

Color	LED characteristic	Description
Green constant		No error – Actuating
Green flashing @ 1.5 Hz		Neutral – Power save
Red constant		Internal error
Red flashing @ 1.5 Hz		External or Float error

PVEA/PVEA-F/PVEA-CI reaction time

Reaction time	A-direction	B-direction
Neutral to full spool stroke	188 ms	142 ms
Full spool stroke to neutral	125 ms	120 ms

Part numbers for PVEA/PVEA-F/PVEA-CI

Part number	Type	Connector	Protection Class	Interface	Functionality
11103692	PVEA	1x4 DEUTSCH	IP 67	—	Standard
11106795	PVEA-F	1x6 DEUTSCH	IP 67	—	Float B-port
11121945	PVEA-CI	1x4 DEUTSCH	IP 67	J1939/ISObus	Standard
11149437	PVEA-CI	1x4 DEUTSCH	IP 67	CANopen	Standard

Technical Information

PVG 16 Proportional Valve Group
PVG 16 Actuation
PVG 16 connector variants

PVG 16 connector variants for PVEO, PVEA, PVEO-CI, PVEA-CI, PVEA-F with pin layout information.

Pin connector

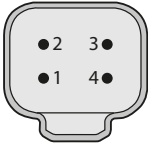
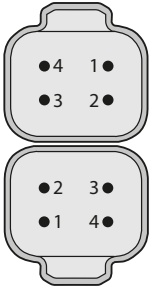
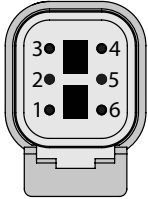
1 x 4 DEUTSCH	2 x 4 DEUTSCH	1 x 6 DEUTSCH
		

Pin layout for PVEO, PVEA, PVEO-CI, PVEA-CI

PVE Type	Connector	Pin 1	Pin 2	Pin 3	Pin 4
PVEO	1 x 4 DEUTSCH	NC2	Vneg	Vneg	NC4
PVEA	1 x 4 DEUTSCH	Vi	SP	Vneg	Vbat
PVEO-CI, PVEA-CI	2 x 4 DEUTSCH	CAN_H	CAN_L	Vbat	Vneg

Pin layout for PVEA-F

Connector	Pin 1	Pin 2	Pin 3	Pin 4	Pin 5	Pin 6
1 x 6 DEUTSCH	Vi	NC	Vf	SP	Vneg	Vbat

Fault Monitoring and Reaction

All proportional control PVG 16 actuators feature:

- Integrated fault monitoring
- Detecting spool stroke inconsistencies
- Detecting internal hardware defects
- Detecting demand signal inconsistencies
- Fault reaction depending on the type of fault monitoring
 - Generic
 - Specific

The PVEA comes with a passive fault monitoring.

Passive fault monitoring

Passive fault monitoring does not disable the solenoid valves when an error is detected. It will continue to operate despite that an error was detected. When the error no longer is registered the passive fault monitoring will “forget” the error and continue as if the error was never there.

With a passive fault monitoring the following conditions will happen when an error is detected/occurs:







- The LED light will switch from green to red and the error pin output will go high
- The solenoid valves will continue operating at the set point given at the time of the error
 - Only exception is if the error is caused by the supply voltage (U_{DC}) being either above or below the allowed range or if the temperature measured on the internal electronics board is higher than allowed. In these cases, the solenoid valves will be disabled.

Generic Fault Reaction

All PVE actuators with fault monitoring are triggered by the following main events:

Control Signal Monitoring	The Control signal voltage (U_S) is continuously monitored. The permissible range is between 15% and 85% of the supply voltage (U_{DC}). Outside this range the PVE will switch into an error state. A disconnected U_S pin (floating) is recognized as a neutral set point.
Transducer/LVDT Supervision	The internal LVDT wires are monitored. If the signals are interrupted or short-circuited, the PVE will switch into an error state.
Supervision of Spool Position	The actual position must always correspond to the demanded position (U_S). If the actual spool position is further out from neutral than the demanded spool position or in opposite direction, the PVE will switch into an error state. Spool position closer to neutral and in same direction will not cause an error state – the situation is considered <i>in control</i> .
Float Position Monitoring	Float position must be entered or left within a time limit. A too high delay on the 1x6 pin float PVE will cause an error state – this is relevant for the 1x6 pin PVEH-F actuators only.
Temperature Monitoring	When the temperature is too high the PVE LED will light constant red and solenoid valves will be disabled.

Fault Monitoring and Reaction
Fault Reaction Overview

Description	Monitoring	LED	Solenoid valves	Error pin output	Reaction time (ms)
Spool not at setpoint	Passive		—	High	250
Unable to reach float position	Passive		—	High	250
$U_{DC} > \text{max.}$	Passive		Disabled	—	250
$U_{DC} < \text{min.}$	Passive	-----	Disabled	—	250
U_S out of range	Passive		—	High	250
LVDT error	Passive		—	High	250
Temp > max.	Passive		Disabled	High	250

PVS End Plates

The PVG 16 PVS end plates close off the valve stack section placed between them by placing them at the end. Furthermore, the end plate is ensuring Load Sense (LS) is relieved to tank pressure when the valve is not operated.

The PVS end plate variants are based on a generic platform with a wide selection of additional features, enabling you to tailor the PVS to suit the demands of any hydraulic system.

The generic PVS end plates platform includes the following main variants:

- **PVS/PVSI** – Either aluminum or cast iron
- **PVS/PVSI with LX-connection** – Either aluminum or cast iron
- **PVSI with P-, T-, LX- and M-connection** – Cast iron
- **PVST with T-connection** – Steel

PVS/PVSI

PVS/PVSI with LX-connection

PVSI with P-, T-, LX- and M-connection

PVST with T-connection

For more information about PVS End Plates, see:

[PVS/PVSI on page 88](#)

[PVS/PVSI with LX-connection on page 90](#)

[PVSI with P-, T-, LX- and M-connection on page 92](#)

[PVST with T-connection on page 94](#)

Technical Information
PVG 16 Proportional Valve Group
PVS End Plates
PVS/PVSI

The PVS/PVSI are made of either aluminum or cast iron material and works as an end plate.

The PVSI Start Plates features:

- Integrated LS pressure relief to tank
- Optional integrated thermal orifice
- Optional version without seals

PVS/PVSI



PVS/PVSI dimensions

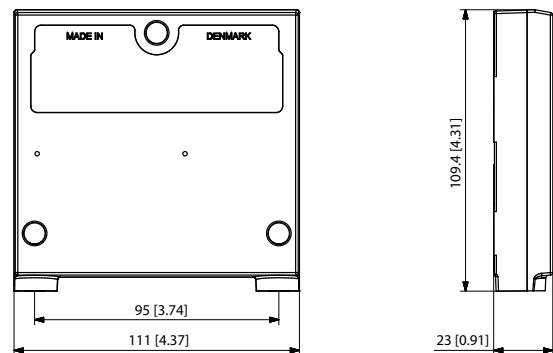

Weight: 0.47 kg [1.05 lb]

PVS/PVSI schematic



[See part number table for details on maximum pressure capacity](#)

Technical specification for A/B-port

Max. continuous pressure	Max. intermittent pressure	Max. rated flow
380 bar [5510 psi]	420 bar [6090 psi]	65 l/min [17 US gal/min]

Technical specification

Parameter	Minimum	Recommended range	Maximum
Fluid temperature	-30°C [-22°F]	30 to 60°C [86 to 140°F]	90° [194°F]
Fluid viscosity	4 mm ² /s [39 SUS]	12 to 75 mm ² /s [65 to 347 SUS]	460 mm ² /s [2128 SUS]
Fluid cleanliness (mechanical activation)	23/19/16 (according to ISO 4406)		
Fluid cleanliness (PVE activation)	18/16/13 (according to ISO 4406)		
Operating temperature	Ambient: -30 to 60°C [-22 to 140°F]		

Part numbers for PVS end plates

Part number	Maximum pressure	Material	Weight kg [lb]	Seals	Mounting
157B2000	300 bar [4351 psi]	Aluminum	0.475 [1.05]	Yes	M8
157B2020	300 bar [4351 psi]	Aluminum	0.475 [1.05]	Yes	5/16-18 UNC

PVS End Plates*Part numbers for PVS end plates (continued)*

Part number	Maximum pressure	Material	Weight kg [lb]	Seals	Mounting
157B2004	350 bar [5076 psi]	Cast iron	1.745 [3.85]	Yes	5/16-18 UNC
157B2014	350 bar [5076 psi]	Cast iron	1.745 [3.85]	Yes	M8

PVS End Plates
PVS/PVSI with LX-connection

The PVG 16 PVS end plates are placed at the end the valve stack section. Furthermore, the end plate is ensuring Load Sense (LS) is relieved to tank pressure when the valve is not operated. The LX port enables other remote valves to be connected onto the Load Sense shuttle network.

The PVS type end plates are made of aluminum while the PVSI types are made of cast iron thereby being able to withstand a higher pressure.

The PVS/PVSI with LX-port connection features:

- Threaded LX port for connecting another valve to LS network

PVS/PVSI with LX-connection



PVS/PVSI with LX-connection dimensions

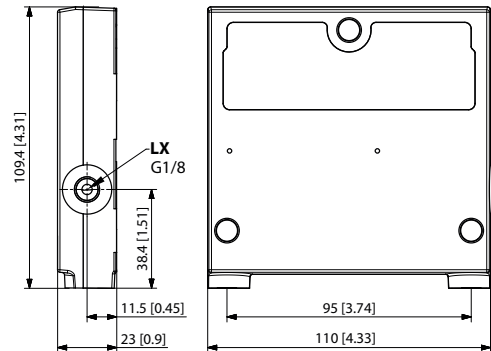

PVS/PVSI with LX-connection schematic

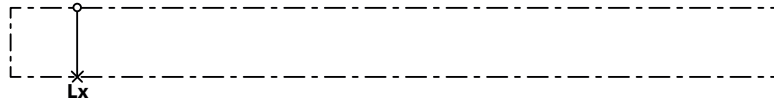

[See part number table for details on maximum pressure capacity](#)

Technical specification for A/B-port

Max. continuous pressure	Max. intermittent pressure	Max. rated flow
380 bar [5510 psi]	420 bar [6090 psi]	65 l/min [17 US gal/min]

Technical specification

Parameter	Minimum	Recommended range	Maximum
Fluid temperature	-30°C [-22°F]	30 to 60°C [86 to 140°F]	90° [194°F]
Fluid viscosity	4 mm ² /s [39 SUS]	12 to 75 mm ² /s [65 to 347 SUS]	460 mm ² /s [2128 SUS]
Fluid cleanliness (mechanical activation)	23/19/16 (according to ISO 4406)		
Fluid cleanliness (PVE activation)	18/16/13 (according to ISO 4406)		
Operating temperature	Ambient: -30 to 60°C [-22 to 140°F]		

PVS End Plates*Part numbers for PVS/PVSI with LX-port connection*

Part number	Max. pressure	Material	Weight kg [lb]	LX port	Mounting
157B2005	350 bar 5076 psi]	Cast iron	1.695 [3.74]	1/2-20 UNF	5/16-18 UNC
157B2015				G1/4"	M8
157B2910				M12x1.5 ISO 6149	
157B2011	300 bar [4351 psi]	Aluminum	0.495 [1.09]	G1/8"	M8
157B2021				3/8-24 UNF	5/16-18 UNC

PVS End Plates
PVSI with P-, T-, LX- and M-connection

PVSI is made of cast iron and works as an end plate. The PVSI with LX connection enables another valves LS pressure to be shuttled to the pump when needed. The additional P- and T-port connections enables an additional pump flow to a PVG 16 valve.

The PVSI with P-, T-, LX- and M-connection features:

- Threaded ports for P/T/LS/LX and M measuring gauge

PVSI with P-, T-, LX- and M-connection

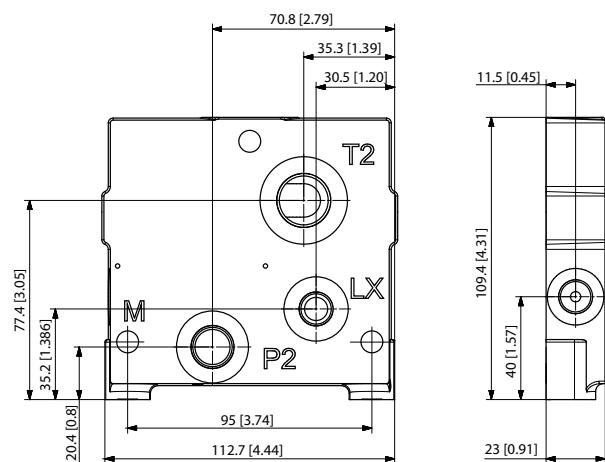
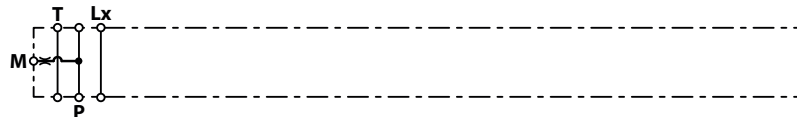
PVSI with P-, T-, LX- and M-connection dimensions

PVSI with P-, T-, LX- and M-connection schematic

Maximum pressure for P- and T-port

Max. P-port continuous	Max. P-port intermittent	Max. T-port static/dynamic
210 bar [3045 psi]	250 bar [3625 psi]	25/40 bar [365/580 psi]

[See part number table for details on maximum pressure capacity](#)

Technical specification for A/B-port

Max. continuous pressure	Max. intermittent pressure	Max. rated flow
380 bar [5510 psi]	420 bar [6090 psi]	65 l/min [17 US gal/min]

Technical specification

Parameter	Minimum	Recommended range	Maximum
Fluid temperature	-30°C [-22°F]	30 to 60°C [86 to 140°F]	90° [194°F]
Fluid viscosity	4 mm ² /s [39 SUS]	12 to 75 mm ² /s [65 to 347 SUS]	460 mm ² /s [2128 SUS]
Fluid cleanliness (mechanical activation)	23/19/16 (according to ISO 4406)		

PVS End Plates*Technical specification (continued)*

Parameter	Minimum	Recommended range	Maximum
Fluid cleanliness (PVE activation)	18/16/13 (according to ISO 4406)		
Operating temperature	Ambient: -30 to 60°C [-22 to 140°F]		

Part number for PVS1 with P-, T-, LX-, M-ports

Part number	P-port	T-port	LX-port	M-port	Mounting feet	Weight
157B2920	G3/8	G1/2	G1/8	G1/4	M8	0.47 kg [1.05 lb]

Technical Information
PVG 16 Proportional Valve Group
PVS End Plates
PVST with T-connection

The PVST end plate closes off the valve stack section placed between them by placing it at the end. Furthermore, the end plate is ensuring Load Sense (LS) is relieved to tank pressure when the valve is not operated.

The PVSI Start Plates features:

- Integrated LS pressure relief to tank
- Threaded T port
- Optional integrated thermal orifice

PVST with T-connection

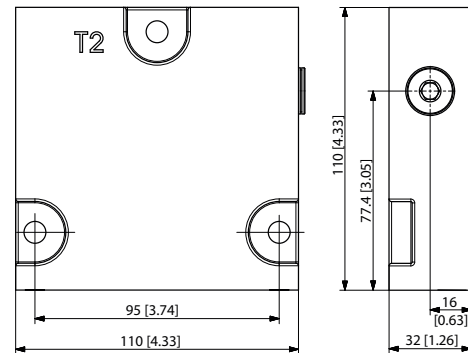
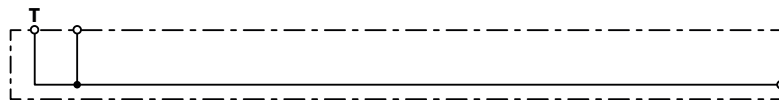
PVST with T-connection dimensions

PVST with T-connection schematic

Maximum pressure for P- and T-port

Max. P-port continuous	Max. P-port intermittent	Max. T-port static/dynamic
350 bar [5076 psi]	400 bar [5800 psi]	25/40 bar [365/580 psi]

Technical specification for A/B-port

Max. continuous pressure	Max. intermittent pressure	Max. rated flow
380 bar [5510 psi]	420 bar [6090 psi]	65 l/min [17 US gal/min]

Technical specification

Parameter	Minimum	Recommended range	Maximum
Fluid temperature	-30°C [-22°F]	30 to 60°C [86 to 140°F]	90° [194°F]
Fluid viscosity	4 mm ² /s [39 SUS]	12 to 75 mm ² /s [65 to 347 SUS]	460 mm ² /s [2128 SUS]
Fluid cleanliness (mechanical activation)	23/19/16 (according to ISO 4406)		
Fluid cleanliness (PVE activation)	18/16/13 (according to ISO 4406)		
Operating temperature	Ambient: -30 to 60°C [-22 to 140°F]		

When using a PVST with T-connection it is not possible to use the LS A/B fitting in the bottom of the PVG section next to the PVST.

PVS End Plates*Part numbers for PVST with T-connection*

Part number	Material	T-port	Mounting feet	Weight
157B2500	Steel	G1/2	M8	0.47 kg [1.05 lb]
157B2520		7/8-14	5/16-18	

PVAS Stay Bolts

PVAS Stay Bolts kit for various PVG combinations consist of three tie rods, six washers, six nuts and O-ring. Use the guide and reference tables how to choose PVAS kit.

The tie rods are inserted through the entire length of the PVG valve stack. The nuts are tightened at the pump side and at the end plate.

To find the PVAS kit that fits your PVG 16 valve stack, you need to go to the table [PVG 16 modules total length and weight](#) on page 97 and find the length. Then go to the table [PVAS Part Numbers](#) on page 97 and find the matching part number.

For stay bolts for a PVG 32/16 combination, see this [PVG 32/16 Combinations](#) on page 98.

Stay bolts for PVG 256/128/32/16 combinations consist of two different kits. See [PVG 256/128/32/16 Combinations](#) on page 99 to find the right kits for your combination.

[Combinations with PVG 100 and PVG 120](#) requires special PVAS kits. These are not included in the PVAS table.

Technical Information
PVG 16 Proportional Valve Group
PVAS Stay Bolts
PVAS Part Numbers

PVAS part numbers according to accumulated length interval PVG 16.

PVAS part numbers

Length, mm [in]	Part number	Length, mm [in]	Part number
20 – 48 [0.79 – 1.89]	11188219	361 – 372 [14.21 – 14.65]	11188205
49 – 60 [1.93 – 2.36]	11188218	373 – 384 [14.69 – 15.12]	157B8026
61 – 72 [2.40 – 2.83]	157B8000	385 – 396 [15.16 – 15.59]	11188204
73 – 84 [2.87 – 3.31]	11188217	397 – 408 [15.63 – 16.06]	157B8007
85 – 96 [3.35 – 3.78]	157B8031	409 – 420 [16.10 – 16.54]	11188203
97 – 108 [3.82 – 4.25]	11188216	421 – 432 [16.58 – 17.01]	157B8027
109 – 120 [4.29 – 4.72]	157B8001	433 – 444 [17.05 – 17.48]	11188202
121 – 132 [4.76 – 5.20]	11188215	445 – 456 [17.52 – 17.95]	157B8008
133 – 144 [5.24 – 5.67]	157B8021	457 – 468 [17.99 – 18.43]	11188201
145 – 156 [5.71 – 6.14]	11188214	469 – 480 [18.47 – 18.90]	157B8028
157 – 168 [6.18 – 6.61]	157B8002	481 – 492 [18.94 – 19.37]	11188200
169 – 180 [6.65 – 7.09]	11188213	493 – 504 [19.41 – 19.84]	157B8009
181 – 192 [7.13 – 7.56]	157B8022	505 – 516 [19.88 – 20.31]	11188199
193 – 204 [7.60 – 8.03]	11188212	517 – 528 [20.35 – 20.79]	157B8029
205 – 216 [8.07 – 8.50]	157B8003	529 – 540 [20.83 – 21.26]	11188198
217 – 228 [8.54 – 8.98]	11188211	541 – 552 [21.30 – 21.73]	157B8010
229 – 240 [9.02 – 9.45]	157B8023	553 – 564 [21.77 – 22.20]	11188197
241 – 252 [9.49 – 9.92]	11188210	565 – 576 [22.24 – 22.68]	157B8030
253 – 264 [9.96 – 10.39]	157B8004	577 – 588 [22.72 – 23.15]	11188196
265 – 276 [10.43 – 10.87]	11188209	589 – 600 [23.19 – 23.62]	157B8061
277 – 288 [10.91 – 11.34]	157B8024	601 – 612 [23.66 – 24.09]	11188195
289 – 300 [11.38 – 11.81]	11188208	613 – 624 [24.13 – 24.57]	157B8081
301 – 312 [11.85 – 12.28]	157B8005	625 – 636 [24.61 – 25.04]	11188194
313 – 324 [12.32 – 12.76]	11188207	637 – 648 [25.08 – 25.51]	157B8062
325 – 336 [12.80 – 13.23]	157B8025	649 – 660 [25.55 – 25.98]	11188189
337 – 348 [13.27 – 13.70]	11188206	661 – 672 [26.02 – 26.46]	157B8082
349 – 360 [13.74 – 14.17]	157B8006		

PVG 16 modules total length and weight

Table with total length of the PVG 16 depending on the number of PVB modules.

No. of PVB 16	1	2	3	4	5	6	7	8	9	10	11	12
Length mm [in]	111 [4.37]	151 [5.94]	191 [7.52]	231 [9.09]	271 [10.67]	311 [12.24]	351 [13.82]	391 [15.39]	431 [16.97]	471 [18.54]	511 [20.12]	551 [21.69]
Weight* kg [lb]	7.2 [15.9]	10.9 [24]	14.6 [32.2]	18.3 [40.3]	22.0 [48.5]	25.7 [56.7]	29.4 [64.8]	33.1 [73]	36.8 [81.1]	40.5 [89.3]	44.2 [97.4]	47.9 [105.6]

* Weight is for a PVG 16 with a PVE on each working section and is only approximate.

PVAS Stay Bolts
PVG 32/16 Combinations

The table of PVB 32 and PVB 16 modules combination, the total length depending on the amount of valve groups.

		PVB 16										
Modules in mm [in]		1	2	3	4	5	6	7	8	9	10	11
PVB 32	1	159 [6.26]	199 [7.83]	239 [9.41]	279 [10.98]	319 [12.56]	359 [14.13]	399 [15.71]	439 [17.28]	479 [18.86]	519 [20.43]	559 [22.01]
	2	207 [8.15]	247 [9.72]	287 [11.30]	327 [12.87]	367 [14.45]	407 [16.02]	447 [17.60]	487 [19.17]	527 [20.74]	567 [22.32]	607 [23.90]
	3	255 [10.04]	295 [11.61]	335 [13.19]	375 [14.76]	415 [16.34]	455 [17.91]	495 [19.49]	535 [21.06]	575 [22.64]	615 [24.21]	655 [25.79]
	4	303 [11.93]	343 [13.50]	383 [15.08]	423 [16.65]	463 [18.23]	503 [19.80]	543 [21.38]	583 [22.95]	623 [24.53]	663 [26.10]	-
	5	351 [13.82]	391 [15.39]	431 [16.97]	471 [18.54]	511 [20.12]	551 [21.69]	591 [23.27]	631 [24.84]	671 [26.42]	-	-
	6	399 [15.71]	439 [17.28]	479 [18.86]	519 [20.43]	559 [22.01]	599 [23.58]	639 [25.16]	-	-	-	-
	7	447 [17.60]	487 [19.17]	527 [20.75]	567 [22.32]	607 [23.90]	647 [25.47]	-	-	-	-	-
	8	495 [19.49]	535 [21.06]	575 [22.64]	615 [24.21]	655 [25.79]	-	-	-	-	-	-
	9	543 [21.38]	583 [22.95]	623 [24.53]	663 [26.10]	-	-	-	-	-	-	-
	10	591 [23.27]	631 [24.84]	671 [26.42]	-	-	-	-	-	-	-	-
	11	639 [25.16]	-	-	-	-	-	-	-	-	-	-

PVAS Stay Bolts
PVG 256/128/32/16 Combinations

The tables of PVB 256/128, 32/16 modules, total length depending on the amount of valve groups.

Stay bolts for PVG 128/256/32/16 combinations consist of 2 different kits:

1. For PVAS containing 2 stay bolts – please look in the *Table 1* below and use the part number before the + symbol.
2. For PVAS containing 3 stay bolts – please look in *Table 1* below and write down the length in millimeters which is the number after the + symbol. Next you add the number from *Table 2* below. Now find the part number for the needed stay bolts in the table *PVAS Part Numbers* on page 97.

O-rings are a part of the PVAS kits – no additional part number needed.

 **Caution**

It is not possible to do combinations exceeding **672 mm**.

Example

For 2 PVB 256 and 1 PVB 128 and 1 PVB 32 and 2 PVB 16: PVAS 1 Part number = **11187681** from *Table 1*.

PVAS 2 = **278** mm from *Table 1* + **152** mm from *Table 2* = 278+152 = 430 mm which equals **157B8027** in the PVAS table.

Table 2 – PVG 256/128 combinations

		PVB 256							
Modules (mm)		0	1	2	3	4	5	6	7
PVB 128	0	11187676+ 40	11187672+ 126	11187673+ 212	11187656+ 298	11187675+ 384	11187696+ 470	11187697+ 556	11187698+ 642
	1	11187320+ 106	11187677+ 192	11187681+ 278	11187658+ 364	11187685+ 450	11187687+ 536	11187690+ 622	
	2	11187617+ 172	11187678+ 258	11187682+ 344	11187686+ 430	11187691+ 516	11187704+ 602		
	3	11187655+ 238	11187679+ 324	11187683+ 410	11187705+ 496	11187694+ 582	11187695+ 668		
	4	11187684+ 304	11187680+ 390	11187696+ 476	11187697+ 562	11187689+ 648			
	5	11187658+ 370	11187699+ 456	11187688+ 542	11187710+ 628				
	6	11187693+ 436	11187703+ 522	11187704+ 608					
	7	11187705+ 502	11187694+ 588						
	8	11187692+ 568	11187709+ 654						
	9	11187710+ 634							

PVAS Stay Bolts

Table 2 – PVG 32/16 combinations

		PVB 16										
Modules (mm)	0	1	2	3	4	5	6	7	8	9	10	
PVB 32	0	-	64	104	144	184	224	264	304	344	384	424
	1	72	112	152	192	232	272	312	352	392	432	-
	2	120	160	200	240	280	320	360	400	440	-	-
	3	168	208	248	288	328	368	408	448	-	-	-
	4	216	256	296	236	276	416	456	-	-	-	-
	5	264	304	344	384	424	464	-	-	-	-	-
	6	312	352	392	432	472	-	-	-	-	-	-
	7	360	400	440	480	-	-	-	-	-	-	-
	8	408	448	488	-	-	-	-	-	-	-	-
	9	456	496	-	-	-	-	-	-	-	-	-
	10	504	-	-	-	-	-	-	-	-	-	-

Technical Information
PVG 16 Proportional Valve Group
PVG 16 Combinations Valve Stack Dimensions
PVG 16 Dimensions

The table of PVB 16 valve stack dimensions overview table with accompanying drawing.

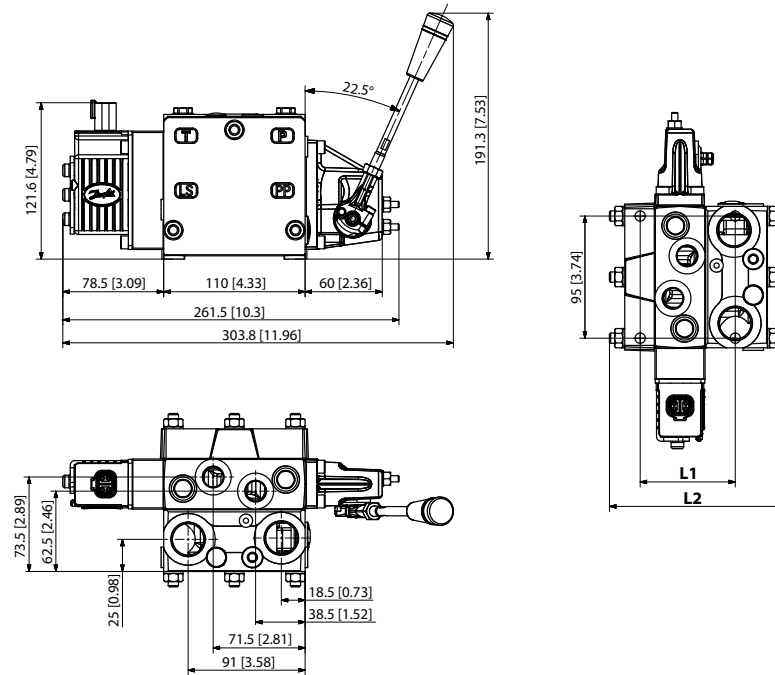

PVB 16 dimensions (12 sections)

Number of PVB 16		1	2	3	4	5	6	7	8	9	10	11	12
L1	mm [in]	74 [2.91]	114 [4.49]	154 [6.06]	194 [7.64]	234 [9.21]	274 [10.79]	314 [12.36]	354 [13.94]	394 [15.51]	434 [17.09]	474 [18.66]	514 [20.24]
L2	mm [in]	140 [5.51]	189 [7.44]	213 [8.39]	262 [10.31]	311 [12.24]	336 [13.23]	385 [15.16]	434 [17.09]	458 [18.03]	507 [19.96]	551 [21.69]	576 [22.68]

PVG 16 Combinations Valve Stack Dimensions
PVG 32/16 Dimensions

The table of PVB 32 and PVB 16 combination valve stack dimensions overview table with accompanying drawing.

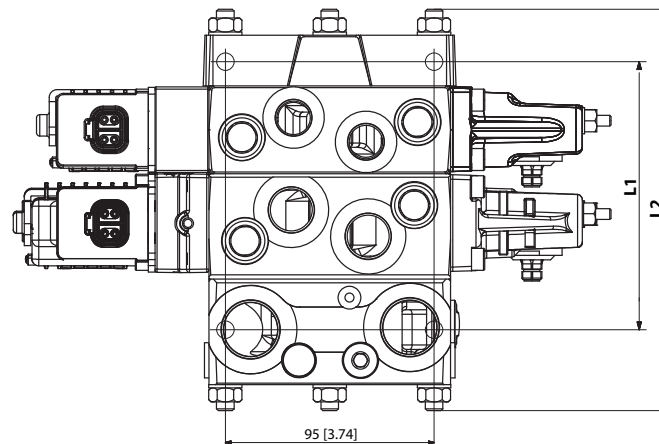

PVB 32/16 combination valve stack dimensions, mm [in]

Number of PVB 32 (down)		Number of PVB 16 modules										
		1	2	3	4	5	6	7	8	9	10	11
1	L1	122 [4.80]	162 [6.38]	202 [7.95]	242 [9.53]	282 [11.10]	322 [12.68]	362 [14.25]	402 [15.83]	442 [17.40]	482 [18.98]	522 [20.55]
	L2	189 [7.44]	238 [9.37]	262 [10.31]	311 [12.24]	360 [14.17]	385 [15.16]	434 [17.09]	483 [19.02]	507 [19.96]	551 [21.69]	600 [23.62]
2	L1	170 [6.69]	210 [8.27]	250 [9.84]	290 [11.42]	330 [12.99]	370 [14.57]	410 [16.14]	450 [17.72]	490 [19.29]	530 [20.87]	570 [22.44]
	L2	238 [9.37]	287 [11.30]	311 [12.24]	360 [14.17]	409 [16.10]	434 [17.09]	483 [19.02]	507 [19.96]	551 [21.69]	600 [23.62]	646 [25.43]
3	L1	218 [8.58]	258 [10.16]	298 [11.73]	338 [13.31]	378 [14.88]	418 [16.46]	458 [18.03]	498 [19.61]	538 [21.18]	578 [22.76]	-
	L2	287 [11.30]	336 [13.23]	360 [14.17]	409 [16.10]	458 [18.03]	483 [19.02]	527 [20.75]	576 [22.68]	600 [23.62]	646 [25.43]	-
4	L1	266 [10.47]	306 [12.05]	346 [13.62]	386 [15.20]	426 [16.77]	466 [18.35]	506 [19.92]	546 [21.50]	586 [23.07]	-	-
	L2	336 [13.23]	385 [15.16]	409 [16.10]	458 [18.03]	483 [19.02]	527 [20.75]	576 [22.68]	622 [24.49]	646 [25.43]	-	-
5	L1	314 [12.36]	354 [13.94]	394 [15.51]	434 [17.09]	474 [18.66]	514 [20.24]	554 [21.81]	594 [23.39]	-	-	-
	L2	385 [15.16]	434 [17.09]	458 [18.03]	507 [19.96]	551 [21.69]	576 [22.68]	622 [24.49]	670 [26.38]	-	-	-
6	L1	362 [14.25]	402 [15.83]	442 [17.40]	482 [18.98]	522 [20.55]	562 [22.13]	602 [23.70]	-	-	-	-
	L2	434 [17.09]	483 [19.02]	507 [19.96]	551 [21.69]	600 [23.62]	622 [24.49]	670 [26.38]	-	-	-	-
7	L1	410 [16.14]	450 [17.72]	490 [19.29]	530 [20.87]	570 [22.44]	610 [24.02]	-	-	-	-	-
	L2	483 [19.02]	527 [20.75]	551 [21.69]	600 [23.62]	646 [25.43]	670 [26.38]	-	-	-	-	-
8	L1	458 [18.03]	498 [19.61]	538 [21.18]	578 [22.76]	-	-	-	-	-	-	-
	L2	527 [20.75]	576 [22.68]	600 [23.62]	646 [25.43]	-	-	-	-	-	-	-

PVG 16 Combinations Valve Stack Dimensions
PVB 32/16 combination valve stack dimensions, mm [in] (continued)

Number of PVB 32 (down)		Number of PVB 16 modules										
		1	2	3	4	5	6	7	8	9	10	11
9	L1	506 [19.92]	546 [21.50]	586 [23.07]	-	-	-	-	-	-	-	-
	L2	576 [22.68]	622 [24.49]	646 [25.43]	-	-	-	-	-	-	-	-
10	L1	554 [21.81]	594 [23.39]	-	-	-	-	-	-	-	-	-
	L2	622 [24.49]	670 [26.38]	-	-	-	-	-	-	-	-	-
11	L1	602 [23.70]	-	-	-	-	-	-	-	-	-	-
	L2	670 [26.38]	-	-	-	-	-	-	-	-	-	-

Weight for a PVG 32/16 valve stack
The combined weight of a PVG 32/16 valve stack can be defined like this:
(Numbers of PVB 32 x 4,42) + (numbers of PVB 16 x 3,67) + 3,6 = Weight in kg
(Numbers of PVB 32 x 9.75) + (numbers of PVB 16 x 8.09) + 7.95 = Weight in lb

PVG 16 Combinations Valve Stack Dimensions
PVG 100/16 Dimensions

The table of PVB 100 and PVB 16 combination valve stack dimensions overview table with accompanying drawing.

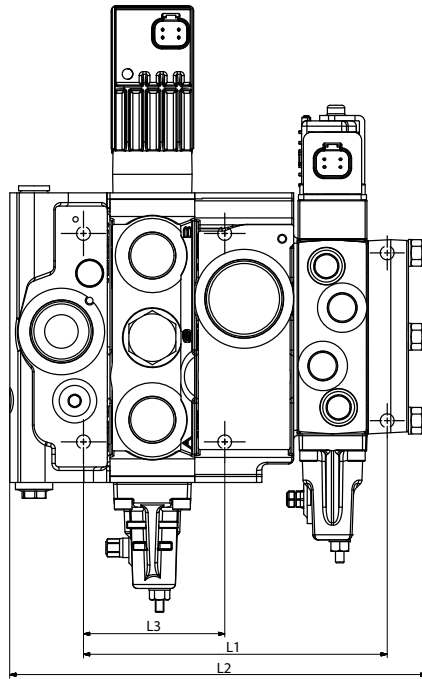

PVB 100/16 combination valve stack dimensions, mm [in]

Number of PVB 100 (down)		Number of PVB 16										
		1	2	3	4	5	6	7	8	9	10	11
1	L1	172 [6.77]	212 [8.35]	252 [9.92]	292 [11.50]	332 [13.07]	372 [14.65]	412 [16.22]	452 [17.80]	492 [19.37]	532 [20.94]	572 [22.52]
	L2	236 [9.29]	285 [11.22]	311 [12.24]	358 [14.09]	407 [16.02]	432 [17.01]	481 [18.94]	530 [20.87]	554 [21.81]	603 [23.74]	652 [25.67]
	L3	80 [3.15]										
2	L1	220 [8.66]	260 [10.24]	300 [11.81]	340 [13.39]	380 [14.96]	420 [16.54]	460 [18.11]	500 [19.69]	540 [21.26]	580 [22.83]	620 [24.41]
	L2	284 [11.18]	333 [13.11]	359 [14.13]	406 [15.98]	455 [17.91]	480 [18.90]	529 [20.83]	578 [22.76]	602 [23.70]	651 [25.63]	700 [27.56]
	L3	128 [5.04]										
3	L1	268 [10.55]	308 [12.13]	348 [13.70]	388 [15.28]	428 [16.85]	468 [18.43]	508 [20.00]	548 [21.57]	588 [23.15]	628 [24.72]	668 [26.30]
	L2	332 [13.07]	381 [15.00]	407 [16.02]	454 [17.87]	503 [19.80]	528 [20.79]	577 [22.72]	626 [24.65]	650 [25.59]	699 [27.52]	748 [29.45]
	L3	176 [6.93]										
4	L1	316 [12.44]	256 [10.08]	396 [15.59]	436 [17.17]	476 [18.74]	516 [20.31]	556 [21.89]	596 [23.46]	636 [25.04]	676 [26.61]	716 [28.19]
	L2	380 [14.96]	429 [16.89]	455 [17.91]	502 [19.76]	551 [21.69]	576 [22.68]	625 [24.61]	674 [26.54]	698 [27.48]	747 [29.41]	796 [31.34]
	L3	224 [8.82]										

PVG 16 Combinations Valve Stack Dimensions
PVB 100/16 combination valve stack dimensions, mm [in] (continued)

Number of PVB 100 (down)		Number of PVB 16										
		1	2	3	4	5	6	7	8	9	10	11
5	L1	364 [14.33]	404 [15.91]	444 [17.48]	484 [19.06]	524 [20.63]	564 [22.20]	604 [23.78]	644 [25.35]	684 [26.93]	724 [28.50]	-
	L2	428 [16.85]	477 [18.78]	503 [19.80]	550 [21.65]	599 [23.58]	624 [24.57]	673 [26.50]	722 [28.43]	746 [29.37]	795 [31.30]	-
	L3	272 [10.71]										
6	L1	412 [16.22]	452 [17.80]	492 [19.37]	532 [20.94]	572 [22.52]	612 [24.09]	652 [25.67]	692 [27.24]	732 [28.82]	-	-
	L2	476 [18.74]	525 [20.67]	551 [21.69]	598 [23.54]	647 [25.47]	672 [26.46]	721 [28.39]	770 [30.31]	794 [31.26]	-	-
	L3	320 [12.60]										
7	L1	460 [18.11]	500 [19.69]	540 [21.26]	580 [22.83]	620 [24.41]	660 [25.98]	700 [27.56]	740 [29.13]	-	-	-
	L2	524 [20.63]	573 [22.56]	599 [23.58]	646 [25.43]	695 [27.36]	720 [28.35]	769 [30.28]	818 [32.20]	-	-	-
	L3	368 [14.49]										
8	L1	508 [20.00]	548 [21.57]	588 [23.15]	628 [24.72]	668 [26.30]	708 [27.87]	748 [29.45]	-	-	-	-
	L2	572 [22.52]	621 [24.45]	647 [25.47]	694 [27.32]	743 [29.25]	768 [30.24]	817 [32.17]	-	-	-	-
	L3	416 [16.38]										

Weight for a PVG 100/16 valve stack
The combined weight of a PVG 100/16 valve stack can be defined like this:
(Numbers of PVB 100 x 7) + (numbers of PVB 16 x 3.67) + 10 = Weight in kg
(Numbers of PVB 100 x 9.37) + (numbers of PVB 16 x 8.09) + 22 = Weight in lb

PVG 16 Combinations Valve Stack Dimensions
PVG 120/16 Dimensions

The table of PVB 120 and PVB 16 combination valve stack dimensions overview table with accompanying drawing.

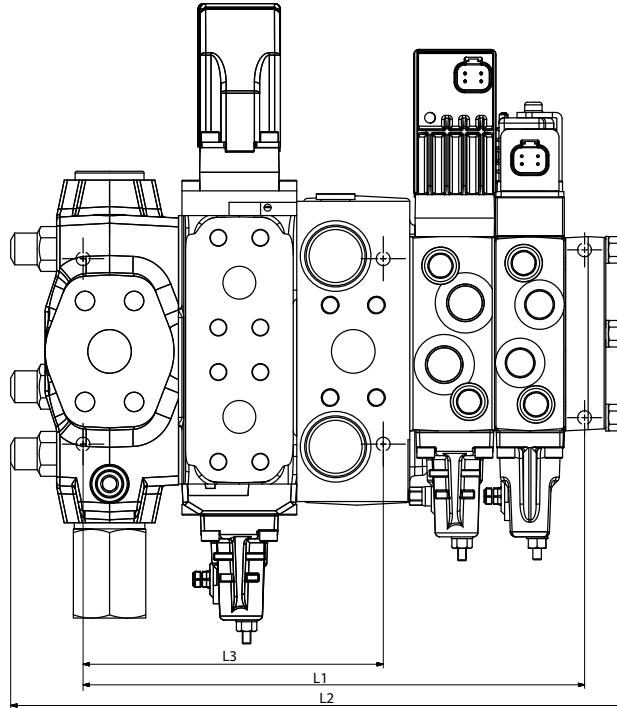

PVB 120/16 combination valve stack dimensions, mm [in]

Number of PVB 120 (down)		Number of PVB 16 modules										
		1	2	3	4	5	6	7	8	9	10	11
1	L1	284 [11.18]	324 [12.76]	364 [14.33]	404 [15.91]	444 [17.48]	484 [19.06]	524 [20.63]	564 [22.20]	604 [23.78]	644 [25.35]	684 [26.93]
	L2	348 [13.70]	397 [15.63]	421 [16.57]	470 [18.50]	519 [20.43]	544 [21.42]	593 [23.35]	642 [25.28]	666 [26.22]	715 [28.15]	759 [29.88]
	L3	80 [3.15]										
2	L1	351 [13.82]	391 [15.39]	431 [16.97]	471 [18.54]	511 [20.12]	551 [21.69]	591 [23.27]	631 [24.84]	671 [26.42]	711 [27.99]	751 [29.57]
	L2	413 [16.26]	462 [18.19]	486 [19.13]	535 [21.06]	584 [22.99]	609 [23.98]	658 [25.91]	707 [27.83]	731 [28.78]	780 [30.71]	824 [32.44]
	L3	128 [5.04]										
3	L1	418 [16.46]	458 [18.03]	498 [19.61]	538 [21.18]	578 [22.76]	618 [24.33]	658 [25.91]	698 [27.48]	738 [29.06]	778 [30.63]	818 [32.20]
	L2	478 [18.82]	527 [20.75]	551 [21.69]	600 [23.62]	649 [25.55]	674 [26.54]	723 [28.46]	772 [30.39]	796 [31.34]	845 [33.27]	889 [35.00]
	L3	176 [6.93]										
4	L1	485 [19.09]	525 [20.67]	565 [22.24]	605 [23.82]	645 [25.39]	685 [26.97]	725 [28.54]	765 [30.12]	805 [31.69]	845 [33.27]	885 [34.84]
	L2	543 [21.38]	592 [23.31]	616 [24.25]	665 [26.18]	714 [28.11]	739 [29.09]	788 [31.02]	837 [32.95]	861 [33.9]	910 [35.83]	954 [37.56]
	L3	224 [8.82]										

PVG 16 Combinations Valve Stack Dimensions
PVB 120/16 combination valve stack dimensions, mm [in] (continued)

Number of PVB 120 (down)		Number of PVB 16 modules										
		1	2	3	4	5	6	7	8	9	10	11
5	L1	552 [21.73]	592 [23.31]	632 [24.8]	672 [26.46]	712 [28.03]	752 [29.61]	792 [31.18]	832 [32.76]	872 [34.33]	912 [35.91]	-
	L2	608 [23.94]	657 [25.87]	681 [26.81]	730 [28.74]	779 [30.67]	804 [31.65]	853 [33.58]	902 [35.51]	926 [36.46]	975 [38.39]	-
	L3	272 [10.71]										
6	L1	619 [24.37]	659 [25.94]	699 [27.52]	739 [29.09]	779 [30.67]	819 [32.24]	859 [33.82]	899 [35.39]	939 [36.97]	-	-
	L2	673 [26.50]	722 [28.43]	746 [29.37]	795 [31.30]	844 [33.23]	869 [34.21]	918 [36.14]	967 [38.07]	991 [39.02]	-	-
	L3	320 [12.60]										
7	L1	686 [27.01]	726 [28.58]	766 [30.16]	806 [31.73]	846 [33.31]	886 [34.88]	926 [36.46]	966 [38.03]	-	-	-
	L2	738 [29.06]	787 [30.98]	811 [31.93]	860 [33.86]	909 [35.79]	934 [36.77]	983 [38.70]	1032 [40.63]	-	-	-
	L3	368 [14.49]										
8	L1	753 [29.65]	793 [31.22]	833 [32.80]	873 [34.37]	913 [35.94]	953 [37.52]	993 [39.09]	-	-	-	-
	L2	803 [31.61]	852 [33.54]	876 [34.49]	925 [36.42]	974 [38.35]	999 [39.33]	1048 [41.26]	-	-	-	-
	L3	639 [25.16]										

There is a horizontal difference 62.5 mm [2.46 in] in the mounting plane of the PVG 120/PVG 16.

The PVG 120 interface module is large sized.

It is necessary to have at least one PVG 32 module between the PVGI and the first PVG 16 slice.

Technical Information
PVG 16 Proportional Valve Group
PVG 16 Combinations Valve Stack Dimensions
PVG 128/16 Dimensions

The table of PVB 128 and PVB 16 combination valve stack dimensions overview table with accompanying drawing.

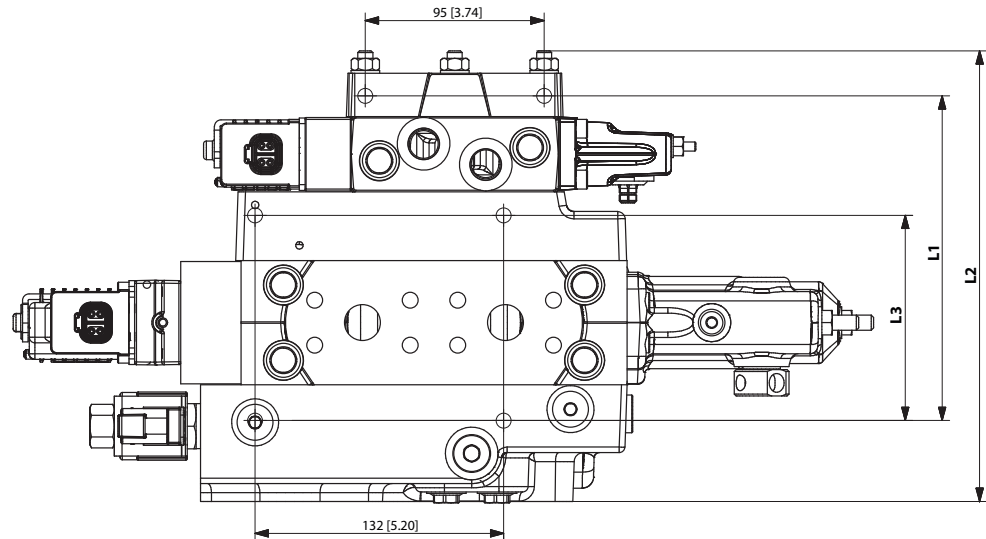

PVB 128/PVB 16 valve stack dimensions, mm [in]

Number of PVB 128 (down)		Number of PVB 16										
		1	2	3	4	5	6	7	8	9	10	11
1	L1	173 [6.81]	213 [8.39]	253 [9.96]	293 [11.54]	333 [13.11]	373 [14.69]	413 [16.26]	453 [17.83]	493 [19.41]	533 [20.98]	573 [22.56]
	L2	297,5 [11.71]	346,5 [13.64]	382,5 [15.06]	418,5 [16.48]	467,5 [18.41]	503,5 [19.82]	540,5 [21.28]	588,5 [23.17]	625,5 [24.63]	661,5 [26.04]	685,5 [26.99]
	L3	98,5 [3.88]										
2	L1	239 [9.41]	279 [10.98]	319 [12.56]	359 [14.13]	399 [15.71]	439 [17.28]	479 [18.86]	519 [20.43]	559 [22.01]	599 [23.58]	—
	L2	370,5 [14.59]	406,5 [16.00]	455,5 [17.93]	491,5 [19.35]	528,5 [20.81]	576,5 [22.70]	588,5 [23.17]	649,5 [25.57]	697,5 [27.46]	734,5 [28.92]	—
	L3	164,5 [6.48]										
3	L1	305 [12.01]	345 [13.58]	385 [15.16]	425 [16.73]	465 [18.31]	505 [19.88]	545 [21.46]	585 [23.03]	—	—	—
	L2	431,5 [16.99]	479,5 [18.88]	515,5 [20.30]	552,5 [21.75]	600,5 [23.64]	637,5 [25.10]	673,5 [26.52]	722,5 [28.44]	—	—	—
	L3	230,5 [9.07]										
4	L1	371 [14.61]	411 [16.18]	451 [17.76]	491 [19.33]	531 [20.91]	571 [22.48]	611 [24.06]	—	—	—	—
	L2	503,5 [19.82]	540,5 [21.28]	588,5 [23.17]	625,5 [24.63]	661,5 [26.04]	709,5 [27.93]	746,5 [29.39]	—	—	—	—
	L3	296,5 [11.67]										
5	L1	437 [17.02]	477 [18.78]	517 [20.35]	557 [21.93]	597 [23.50]	—	—	—	—	—	—
	L2	564,5 [22.22]	612,5 [24.11]	649,5 [25.57]	685,5 [26.99]	734,5 [28.92]	—	—	—	—	—	—
	L3	362,5 [14.27]										

PVG 16 Combinations Valve Stack Dimensions
PVB 128/PVB 16 valve stack dimensions, mm [in] (continued)

Number of PVB 128 (down)		Number of PVB 16										
		1	2	3	4	5	6	7	8	9	10	11
6	L1	503 [19.80]	543 [21.38]	583 [22.95]	—	—	—	—	—	—	—	—
	L2	637,5 [25.10]	673,5 [26.52]	722,5 [28.44]	—	—	—	—	—	—	—	—
	L3	428,5 [16.87]										
7	L1	569 [22.40]	609 [23.98]	—	—	—	—	—	—	—	—	—
	L2	697,5 [27.46]	746,5 [29.39]	—	—	—	—	—	—	—	—	—
	L3	494,5 [19.47]										

Weight for a PVG 128/16 valve stack
The combined weight of a PVG 128/16 valve stack can be defined like this:
(Numbers of PVB 128 x 16.9) + (numbers of PVB 16 x 3,67) + 17.5 = Weight in kg
(Numbers of PVB 128 x 37.26) + (numbers of PVB 16 x 8.09) + 38.6 = Weight in lb

Technical Information
PVG 16 Proportional Valve Group
PVG 16 Combinations Valve Stack Dimensions
PVG 256/16 Dimensions

The table of PVB 256 and PVB 16 combination valve stack dimensions overview table with accompanying drawing.

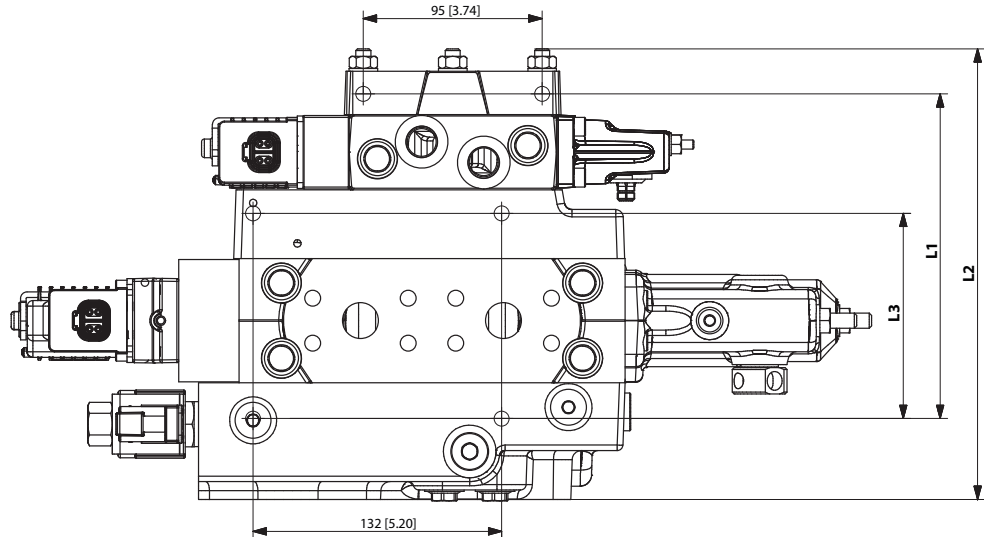

PVB 256/16 combination valve stack dimensions, mm [in]

Number of PVB 256 (down)		Number of PVB 16										
		1	2	3	4	5	6	7	8	9	10	11
1	L1	193 [7.60]	233 [9.17]	273 [10.75]	313 [12.32]	353 [13.90]	393 [15.47]	433 [17.05]	473 [18.62]	513 [20.20]	553 [21.78]	593 [23.35]
	L2	321,5 [12.66]	358,5 [14.11]	406,5 [16.01]	443,5 [17.46]	479,5 [18.88]	528,5 [20.81]	564,5 [22.22]	600,5 [23.64]	649,5 [25.57]	685,5 [26.99]	734,5 [28.92]
	L3	118,5 [4.67]										
2	L1	285 [11.22]	325 [12.80]	365 [14.37]	405 [15.94]	445 [17.52]	485 [19.09]	525 [20.67]	565 [22.24]	605 [23.82]	—	—
	L2	406,5 [16.01]	455,5 [17.93]	491,5 [19.35]	528,5 [20.81]	576,5 [22.70]	612,5 [24.11]	649,5 [25.57]	697,5 [27.46]	734,5 [28.92]	—	—
	L3	204,5 [8.05]										
3	L1	371 [14.61]	411 [16.18]	451 [17.76]	491 [19.33]	531 [20.91]	571 [22.48]	611 [24.06]	—	—	—	—
	L2	491,5 [19.35]	540,5 [21.28]	576,5 [22.70]	612,5 [24.11]	661,5 [26.04]	697,5 [27.46]	734,5 [28.92]	—	—	—	—
	L3	290,5 [11.44]										
4	L1	457 [17.99]	497 [19.57]	537 [21.14]	577 [22.72]	617 [24.29]	—	—	—	—	—	—
	L2	588,5 [23.17]	625,5 [24.63]	661,5 [26.04]	709,5 [27.93]	746,5 [29.39]	—	—	—	—	—	—
	L3	376,5 [14.82]										
5	L1	543 [21.38]	583 [22.95]	623 [24.53]	—	—	—	—	—	—	—	—
	L2	673,5 [26.52]	709,5 [27.93]	746,5 [29.93]	—	—	—	—	—	—	—	—
	L3	462,5 [18.21]										

PVG 16 Combinations Valve Stack Dimensions**Weight for a PVG 256/16 valve stack**

The combined weight of a PVG 256/16 valve stack can be defined like this:

(Numbers of PVB 256 x 20.9) + (numbers of PVB 16 x 3,67) + 17.5 = Weight in kg

(Numbers of PVB 256 x 40.08) + (numbers of PVB 16 x 8.09) + 38.6 = Weight in lb

PVG 16 Applications Schematics

PVG 16 Schematic with Basic End Plate

The schematic example of PVG 16 with basic end plate.

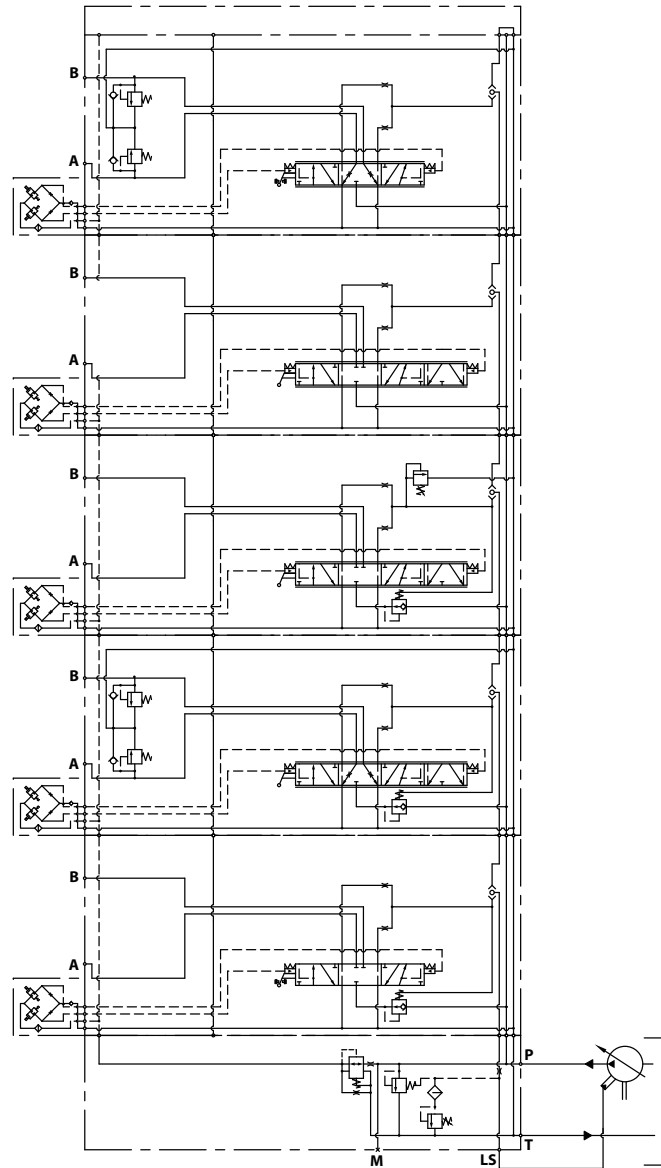

PVG 16 Applications Schematics

PVG 16 with P- and T-connection end plate

The schematic example of PVG 16 with P- and T-connection end plate.

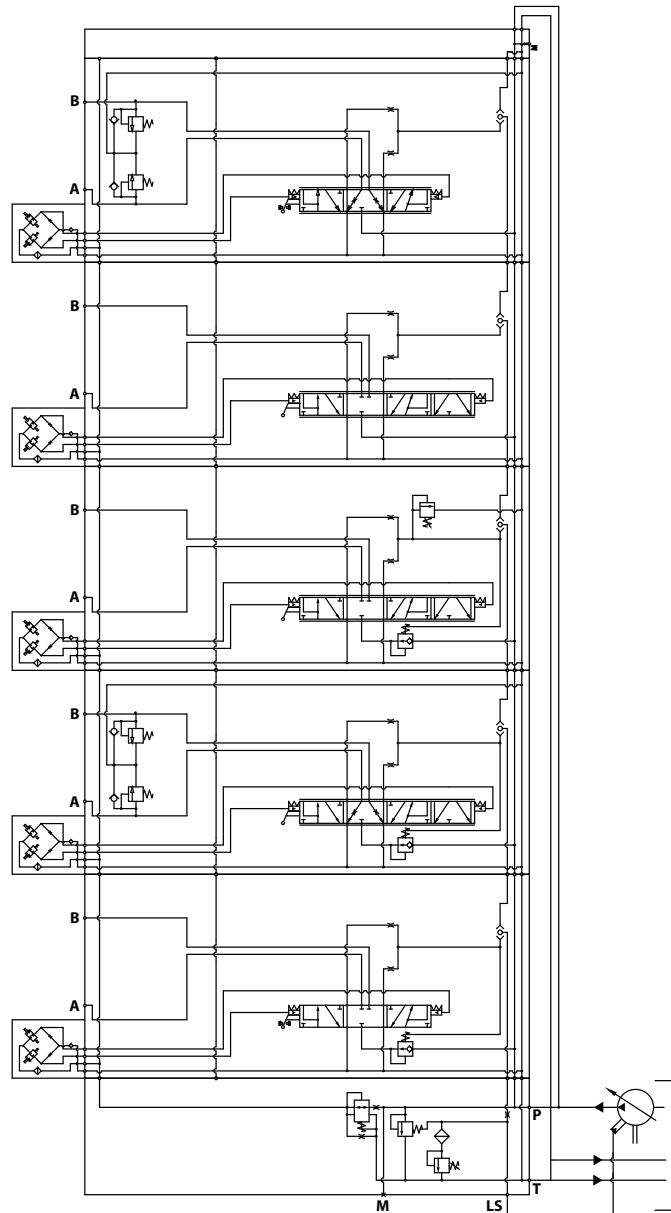

Products we offer:

- Cartridge valves
- DCV directional control valves
- Electric converters
- Electric machines
- Electric motors
- Gear motors
- Gear pumps
- Hydraulic integrated circuits (HICs)
- Hydrostatic motors
- Hydrostatic pumps
- Orbital motors
- PLUS+1° controllers
- PLUS+1° displays
- PLUS+1° joysticks and pedals
- PLUS+1° operator interfaces
- PLUS+1° sensors
- PLUS+1° software
- PLUS+1° software services, support and training
- Position controls and sensors
- PVG proportional valves
- Steering components and systems
- Telematics

Danfoss Power Solutions is a global manufacturer and supplier of high-quality hydraulic and electric components. We specialize in providing state-of-the-art technology and solutions that excel in the harsh operating conditions of the mobile off-highway market as well as the marine sector. Building on our extensive applications expertise, we work closely with you to ensure exceptional performance for a broad range of applications. We help you and other customers around the world speed up system development, reduce costs and bring vehicles and vessels to market faster.

Danfoss Power Solutions – your strongest partner in mobile hydraulics and mobile electrification.

Go to www.danfoss.com for further product information.

We offer you expert worldwide support for ensuring the best possible solutions for outstanding performance. And with an extensive network of Global Service Partners, we also provide you with comprehensive global service for all of our components.

Hydro-Gear

www.hydro-gear.com

Daikin-Sauer-Danfoss

www.daikin-sauer-danfoss.com

Local address:

Danfoss Power Solutions (US) Company
2800 East 13th Street
Ames, IA 50010, USA
Phone: +1 515 239 6000

Danfoss Power Solutions GmbH & Co. OHG
Krokamp 35
D-24539 Neumünster, Germany
Phone: +49 4321 871 0

Danfoss Power Solutions ApS
Nordborgvej 81
DK-6430 Nordborg, Denmark
Phone: +45 7488 2222

Danfoss Power Solutions Trading (Shanghai) Co., Ltd.
Building #22, No. 1000 Jin Hai Rd
Jin Qiao, Pudong New District
Shanghai, China 201206
Phone: +86 21 2080 6201

Danfoss can accept no responsibility for possible errors in catalogues, brochures and other printed material. Danfoss reserves the right to alter its products without notice. This also applies to products already on order provided that such alterations can be made without subsequent changes being necessary in specifications already agreed. All trademarks in this material are property of the respective companies. Danfoss and the Danfoss logotype are trademarks of Danfoss A/S. All rights reserved.