

Technical Information

PVG 32

Proportional Valve Group



Revision history

Table of revisions

Date	Changed	Rev
July 2024	Major revision of document	1601
February 2023	Fixed typo on Flow control spools - closed neutral position	1506
January 2023	Updated schematics and part numbers	1505
October 2022	Updated schematics	1504
June 2022	New revision	1503
June 2022	New revision	1502
April 2022	Updated part numbers and technical data.	1501
May 2021	Various data corrections throughout.	1401
May 2020	Major update, advanced revision number to match online document catalogue.	1301
	Changed document number from 'BC00000038' to 'BC152886483664'	XX
September 2019	Minor revisions throughout	1102
December 2018	Major revision of document.	1101
September 2018	Safety topic, new PVBS spools added.	1001
July 2018	Major update.	0901
November 2017	Dimenions section changes.	0803
August 2017	Added informational note to Technical Data section.	0802
March 2016	Pressure-compensated PVB, open center PVP; Characteristics for float position main spools.	0801
February 2006 - March 2016	Various changes	BA - 0710
January 2005	New Edition	AA

Contents
General Information

General Description.....	7
PVG 32 Features.....	7
Other technical features.....	7
Sectional view.....	9
Safety in Systems.....	10
PVG 32 Technical data.....	12
PVG 32 Modules Overview.....	13

PVP Inlet Modules

Open Center PVP.....	15
Open Center PVP with PPRV.....	18
Open center PVP with HPCO and PVE PPRV.....	22
Closed Center PVP.....	25
Closed Center PVP with PPRV.....	27
Closed Center PVPV.....	30
Closed center PVPV with PPRV.....	31
Open/Closed center PVP with PPRV.....	33
Open/Closed center PVPM.....	36
Open/closed center CC selector.....	37

PVP Inlet Module Accessories

PVPX Electrical LS Pressure Unloading Valve.....	39
Part numbers for PVPX.....	40
PVPC without Check Valve.....	42
PVPC with Check Valve.....	44

PVB Basic Modules

Uncompensated PVB.....	47
Uncompensated PVB with load drop check valve.....	50
Uncompensated PVBZ with POC.....	53
Compensated PVB.....	54
Dampened Compensated PVB.....	57
Dampened compensated PVB with LS A/B.....	60
Compensated PVB with LS A/B.....	63
Compensated high flow PVB.....	67
Compensated high flow PVB with LS A/B.....	70
Compensated PVBZ with POC.....	74
Compensated high flow PVBZ with POC.....	76
Compensated high flow PVBZ with POC and manifold interface	78
Constant pressure PVB.....	80

PVB Basic Modules Accessories

PVLP Shock and Anti-Cavitation Valve.....	83
PVLA Suction Valve.....	85

PVSP and PVSPM Priority Modules

PVSP and PSPVM Versions Overview.....	87
Sectional view of priority modules PVSP/PVSPM.....	89
Compensator spool for PVSP/PVSPM.....	90

PVBD Diverter Module

PVBD Diverter Principle.....	91
PVBD Diverter Module Overview.....	92

PVBS Main Spools

PVBS fluid flow characteristics—Theoretical performance.....	95
Pressure control spool characteristics - Theoretical performance.....	100

PVBS Main Spools Part Numbers

Flow Control Spools—Closed Neutral Position.....	103
Flow Control Spools—Closed Neutral Position with A-float.....	107
Flow Control Spools—Closed Neutral Position with B-float.....	107

Contents

Flow Control Spools—Closed Neutral Position with A-float for PVMF.....	109
Flow Control Spools—Closed Neutral Position with B-float for PVMF.....	109
Flow Control Spools—Closed Neutral Position for PVMR.....	110
Flow Control Spools—Open/Closed Neutral Position.....	110
Flow Control Spools—Throttled Open Neutral Position.....	112
Flow Control Spools—Throttled Open Neutral Position for PVMR.....	116
Flow Control Spools—Throttled A to T Neutral Position.....	117
Flow Control Spools—Throttled B to T Neutral Position.....	118
Flow Control Spools—Closed A and Open/Closed B Position.....	119
Flow Control Spools—Open A and Open/Closed B Position.....	119
Linear Flow Control Spools—Closed Neutral Position.....	120
Linear Flow Control Spools—Throttled Open Neutral Position.....	122
Linear Flow Control Spools—Throttled A to T Neutral Position.....	123
Linear Flow Control Spools—Throttled B to T Neutral Position.....	123
Linear Flow Control Spools—Open/Closed Neutral Position.....	124
Linear Flow Control Spools—Throttled Open Position for PVMR.....	124
Single Acting Cylinder Flow Control Spools—Neutral A-port Position.....	124
Single Acting Cylinder Flow Control Spools—Neutral B-port Position.....	126
Single Acting Cylinder Linear Flow Control Spools—Closed Neutral A-port Position.....	126
Single Acting Cylinder Linear Flow Control Spools—Neutral B-port Position.....	126
Flow/Pressure Control Spools—Closed Neutral Position.....	127
Flow/Pressure Control Spools—Throttled Open Neutral Position.....	128
Pressure/Flow Control Spools—Throttled Open B to T in Neutral Position.....	129
Flow/Pressure Control Spools—Throttled Open A to T in Neutral Position.....	130
Flow/Pressure Control Spools—Throttled Open B to T in Neutral Position.....	131
Flow/Pressure Control Spools—Open/Closed A and Closed B Position.....	131
Flow/Pressure Control Spools—Closed A and Open/Closed B Position.....	131
Pressure Control Spools—Closed Neutral Position.....	132
Pressure Control Spools—Open/Closed A and Closed B Neutral Position.....	132
Pressure Control Spools—Throttled Open Neutral Position.....	133
Pressure Control Spools—Throttled A to T in Neutral Position.....	134
Pressure Control Spools—Throttled B to T in Neutral Position.....	134
Linear Pressure Control Spools—Closed Neutral Position.....	134
Pressure/Flow Control Spools—Closed Neutral Position.....	135
Pressure/Flow Control Spools—Closed Neutral Position with B-float.....	136
Pressure/Flow Control Spools—Throttled Open Neutral Position.....	136
Pressure/Flow Control Spools—Open/Closed Neutral Position.....	136
Pressure/Flow Control Spools—Open/Closed A and Closed B Position.....	137

PVBS for PVBZ Main Spools Part Numbers

PVBZ Flow Control Spools—Closed Neutral Position.....	138
PVBZ Flow Control Spools—Closed Neutral Position with A-float.....	138
PVBZ Flow Control Spools—Closed Neutral Position with B-float.....	139
PVBZ Linear Flow Control Spools—Closed Neutral Position.....	140
PVBZ Single Acting Cylinder Flow Control Spools—Closed Neutral A-port Position.....	140
PVBZ Single Acting Cylinder Linear Flow Control Spools—Closed Neutral B-port Position.....	140
PVBZ–HS Single Acting Cylinder Flow Control Spools—Closed Neutral Position.....	141

PVDI Directional Indicator
PVG 32 Actuation

PVM Manual Actuation.....	144
PVM functionality.....	148
PVMD/F/R Covers.....	149
Part Numbers for PVMD/F/R Covers.....	149
PVML, Spring Centering Cover.....	150
PVH Hydraulic Actuation.....	151
PVHC Electro-Hydraulic Actuation.....	152

PVE Electro-hydraulic Actuation

PVE Series 5.....	156
-------------------	-----

Contents

PVED-CC Series 5.....	156
Operating data overview.....	157
Connectors.....	158
LED coloring for PVED-CC Series 5.....	159
PVED-CC Hysteresis and Ripple.....	159
PVED-CC Reaction Times.....	160
PVED-CC Part Numbers.....	160
PVE Series 7.....	161
PVEO.....	161
PVEO Technical Data.....	163
PVEO Reaction Times.....	164
PVEO Part Numbers.....	164
PVEO-HP.....	166
PVEO-HP Technical Data.....	167
PVEO-HP Reaction Times.....	168
PVEO-HP Part Numbers.....	169
PVEM.....	170
PVEM Technical Data.....	171
PVEM Reaction Times.....	173
PVE Hysteresis and Ripple.....	173
PVEM part numbers.....	173
PVEA.....	174
PVEA Technical Data.....	175
PVEA Reaction Times.....	176
PVE Hysteresis and Ripple.....	176
PVEA part numbers.....	176
PVEH.....	178
PVEH Technical Data.....	178
PVEH Reaction Times.....	180
PVE Hysteresis and Ripple.....	180
PVEH Part Numbers.....	180
PVES.....	182
PVES Technical Data.....	183
PVES Reaction Times.....	184
PVE Hysteresis and Ripple.....	184
PVES Part Numbers.....	185
Connector Overview.....	186
Extension plates for PVE Series 7.....	188
Fault Monitoring and Reaction	
Generic Fault Reaction.....	189
Fault Reaction Overview.....	190
Error Pin Specification.....	190
Functionality Overview	
PWM Voltage Control.....	191
Float A-Port (-FLA).....	192
Float B-Port (-FLB).....	192
PVE Power Save.....	193
Special Features	
Direction Indication (-DI).....	194
Dedicated Float Pin (UF).....	195
Spool Position (SP).....	196
Neutral Power-OFF (NP).....	197
Disable Mode.....	198
PVS End Plates	
PVS/PVSI.....	202
PVS/PVSI with LX-connection.....	204
PVSI with P-, T-, LX- and M-connection.....	206

Contents

PVST with T-connection.....	207
PVSI Start Plate.....	208
PVSD End Plate.....	210
PVSI with PVE PPRV.....	212
PVST with PVE PPRV and PP dump.....	214

PVSKM Full Flow Cut Off Modules

Technical data.....	217
Spool characteristics.....	219

PVAS Stay Bolts

PVAS Part Numbers.....	221
PVG 32 modules total length	222
PVG 32/16 Combinations.....	222
PVG 256/128/32/16 Combinations.....	223

PVG 32 Combinations Valve Stack Dimensions

PVG 32 Dimensions.....	225
PVG 32/16 Dimensions.....	227
PVG 100/32 Dimensions.....	229
PVG 120/32 Dimensions.....	231
PVG 128/32 Dimensions.....	233
PVG 256/32 Dimensions.....	235

PVG schematic and specification examples

General Information

General Description

PVG is a hydraulic, load-sensing proportional valve, designed for optimal machine performance and maximum design flexibility. The PVG valve design is based on a modular concept that enables machine designers to specify a valve solution suitable for multiple market segments across multiple applications.

The PVG 32 is a member of the PVG product platform and interfaces to other valve families enabling all machine functions being controlled from one single valve stack.

PVG 32 controls work port flow up to 125 l/min [33 US gal/min] l/min and up to 420 bar [6090 psi] bar work port pressure.

The load independent proportional control valve and high performance actuator technology combined with a low pressure drop design improves the machine performance and efficiency – increasing productivity and reducing energy consumption.

PVG 32 Features

PVG load-sensing proportional valves features and benefits summarized in bullets below:

- Load-independent flow control:
 - Oil flow to an individual function is independent of the load pressure of this function
 - Oil flow to one function is independent of the load pressure of other functions
- Possible combination with the rest of the PVG family, when using an interface module
- Up to 12 basic modules per PVG 32 valve group
- Reliable regulation characteristics across the entire flow range
- Load sense relief valves for A and B port enables reduced energy loss at target pressure
- Several options for connection threads and flange mount
- Compact design, easy installation and serviceability
- Energy-saving
- Low weight

Other technical features

Inlets, work section housing, and actuation methods features are listed below:

Inlets include:

- Built-in pressure relief valve
- Pressure gauge connection
- Versions for different pump types
 - Open center systems with fixed displacement pumps
 - Closed center systems with variable displacement pumps
- Integrated pilot oil supply

Work section housing include:

- Interchangeable spools
- Pressure gauge connection
- Versions for different application needs:
 - Built-in compensator for load independent flow
 - Built-in load holding check valve in P-channel
 - Integrated shock/suction valve
 - Integrated local pressure relief valve

General Information

Actuation methods include:

- Manual control
 - with lever
 - with friction detent
- Hydraulic control
- Electro-hydraulic
 - ON/OFF control
 - Ratiometric proportional control
 - CAN bus proportional control
 - PWM proportional control

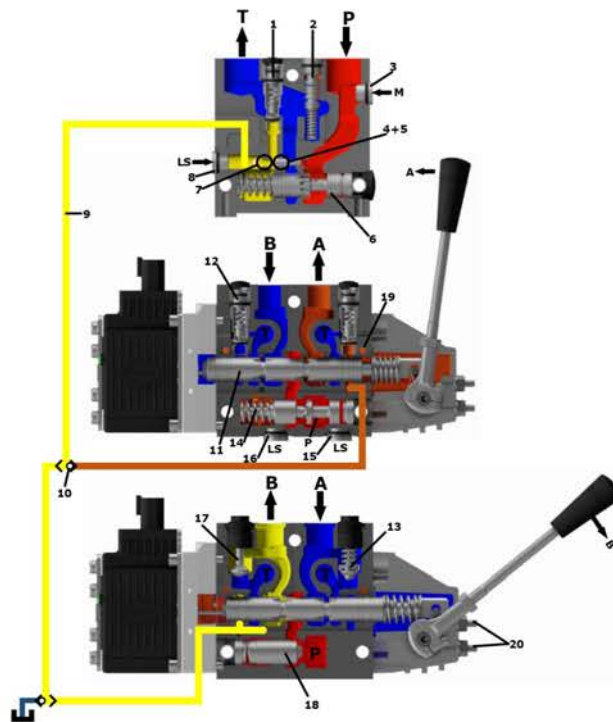
Technical Information
PVG 32 Proportional Valve Group
General Information
Sectional view

- | | | | |
|-----|---|-----|--|
| 1. | Pressure relief valve | 11. | Main spool |
| 2. | Pressure reduction valve for pilot oil supply | 12. | LS pressure limiting valve |
| 3. | Pressure gauge connection | 13. | Shock and suction valve, PVLP |
| 4. | Plug, open center | 14. | Pressure compensator |
| 5. | Orifice, closed center | 15. | LS connection, port A |
| 6. | Pressure adjustment spool | 16. | LS connection, port B |
| 7. | Plug, closed center | 17. | Suction valve, PVLA |
| 8. | LS connection | 18. | Load drop check valve |
| 9. | LS signal | 19. | Pilot oil supply for PVE |
| 10. | Shuttle valve | 20. | Maximum oil flow adjustment screws for A/B ports |

General Information

Safety in Systems

All types and brands of control valves, including proportional valves, can fail. Therefore, the necessary protection against the serious consequences of a functional failure should always be built into the system.

General safety considerations

Warning

Because the proportional valve is used in many different applications and under different operating conditions, it is the sole responsibility of the OEM to ensure that all performance, safety and warning requirements of the application are met in this selection of products and complies with relevant machine-specific and generic standards.

The OEM is fully responsible for making and documenting their own hazard and risk assessment including the consequences of the system in case of pressure failure and uncontrolled movements. The Danfoss documentation can only be used as input for the activity.

Control system example

An example of a control system using an aerial lift is shown below:

Aerial lift



This example breaks down the control system into smaller bits explaining the architecture in depth. Even though many Danfoss components are used in the PVG control system.

The function of the control system is to use the output from the PVE together other external sensors to ensure the PLUS+1 main controllers correct function of the aerial lift.

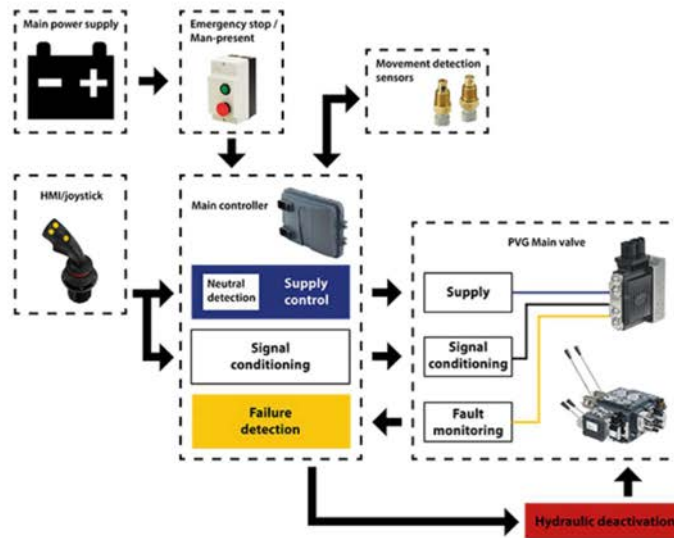
General Information
Electrical block diagram

⚠ Warning

It is the responsibility of the equipment manufacturer that the control system incorporated in the machine is declared as being in conformity with the relevant machine directives.

⚠ Caution

A mix of electrical actuation and hydraulic actuation on the same valve stack is not safe. PVE and PVH are designed for different pilot pressure.

Cost-free repairs, as mentioned in Danfoss General Conditions of Sale, are carried out only at Danfoss or at service shops authorized by Danfoss.

Technical Information
PVG 32 Proportional Valve Group
General Information
PVG 32 Technical data

Maximum pressure	Port P, A/B continuous with PVS end plate	300 bar	[4351 psi]
	Port P, A/B continuous with PVSI end plate	350 bar	[5075 psi]
	Port P intermittent	400 bar	[5800 psi]
	Port A/B intermittent	420 bar	[6090 psi]
	Port T, static/dynamic	25/40 bar	[365/580 psi]
Oil flow rated	Port P with PVP inlet	140 l/min	[37 US gal/min]
	Port P with PVPM/PVPVM mid inlet	230 l/min	[61 US gal/min]
	Port A/B with pressure compensator	100 l/min	[26.4 US gal/min]
	Port A/B without pressure compensator	125 l/min	[33 US gal/min]
Spool travel, standard		± 7 mm	[± 0.28 in]
Spool travel, float position	Proportional range	± 4.8 mm	[± 0.19 in]
	Float position	± 8 mm	[± 0.32 in]
Dead band, flow control spools	Standard	± 1.5 mm	[± 0.06 in]
	Linear characteristic	± 0.8 mm	[± 0.03 in]
Maximum internal leakage at 100 bar [1450 psi] and 21 mm²/s [102 SUS]	A/B → T, PVB without PVLP	20 cm ³ /min	[1.85 in ³ /min]
	A/B → T, PVB with PVLP	25 cm ³ /min	[2.15 in ³ /min]
Maximum internal leakage at 200 bar [2900 psi] and 21 mm²/s [102 SUS]	A/B → T, PVBZ with PO check valves	1 cm ³ /min	[0.06 in ³ /min]
	A/B → T, PVBZ with PO check valves and PVLP	6 cm ³ /min	[0.37 in ³ /min]
Oil temperature (inlet temperature)	Recommended temperature	30 to 60 °C	[86 to 140 °F]
	Minimum temperature	-30 °C	[-22 °F]
	Maximum temperature	90 °C	[194 °F]
Ambient temperature		-30 to 60 °C	[-22 to 140 °F]
Oil viscosity	Operating range	12 to 75 mm ² /s	[65 to 347 SUS]
	Minimum viscosity	4 mm ² /s	[39 SUS]
	Maximum viscosity	460 mm ² /s	[2128 SUS]
Filtration / maximum contamination according to ISO 4406		23/19/16	
Oil consumption in pilot oil reduction valve		0.5 l/min	[0.13 US gal/min]

Technical Information
PVG 32 Proportional Valve Group
General Information
PVG 32 Modules Overview

PVG proportional valve group shown in the exploded view illustration for a quick modules navigation.

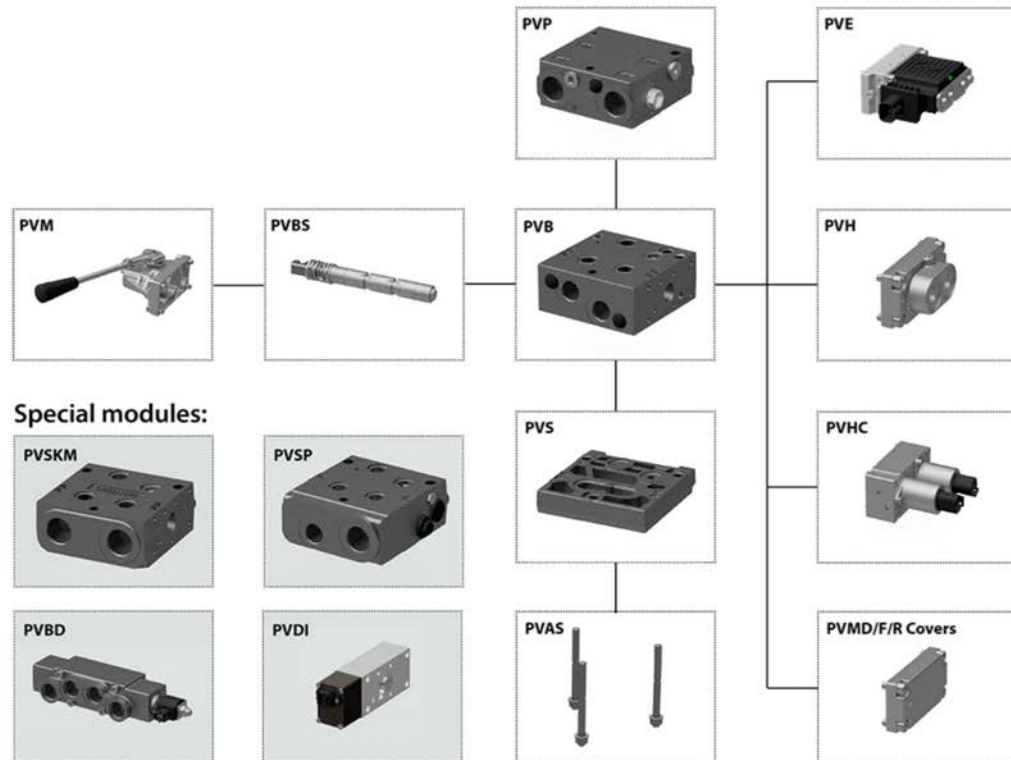
PVG 32 Modules Assembly Overview

PVG Modules Navigation:

[PVP Inlet Modules](#) on page 14 and [PVP Inlet Module Accessories](#) on page 39

[PVB Basic Modules](#) on page 46

[PVSP and PVSPM Priority Modules](#) on page 86

[PVBD Diverter Module](#) on page 91

[PVBS Main Spools](#) on page 94

[PVM Manual Actuation](#) on page 144

[PVE Electro-hydraulic Actuation](#) on page 154

[PVH Hydraulic Actuation](#) on page 151

[PVHC Electro-Hydraulic Actuation](#) on page 152

[PVDI Directional Indicator](#) on page 142

[PVSKM Full Flow Cut Off Modules](#) on page 216

[PVS End Plates](#) on page 199

[PVAS Stay Bolts](#) on page 221

PVP Inlet Modules

The PVG 32 PVP inlet modules, also referred to as pump side modules, act as an interface between the PVG 32 proportional valve group and the hydraulic pump and tank reservoir.

PVP Inlet Module

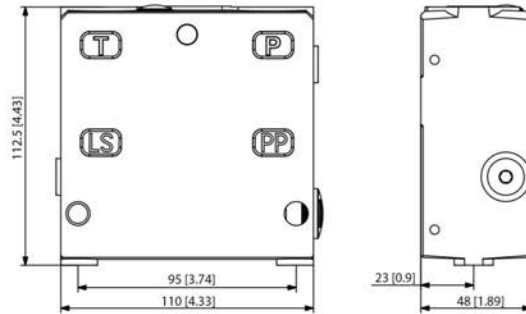
PVP inlet module dimensions

Weight: 3.1 kg [6.9 lb]

Fixed displacement pump symbol

Variable displacement pump symbol

The PVP inlet module variants are based on a generic platform with a selection of additional features, enabling you to tailor the PVP to suit the demands of any hydraulic system:

- [Open Center PVP](#) on page 15 (for fixed displacement pumps)
- [Open Center PVP with PPRV](#) on page 18 (for fixed displacement pumps)
- [Open center PVP with HPCO and PVE PPRV](#) on page 22 (for fixed displacement pumps)
- [Closed Center PVP](#) on page 25 (for variable displacement pumps)
- [Closed Center PVP with PPRV](#) on page 27 (for variable displacement pumps)
- [Closed center PVPV with PPRV](#) on page 31 (for variable displacement pumps)
- [Closed center PVPVM with PPRV](#) (for variable displacement pumps)
- [Open/Closed center PVP with PPRV](#) on page 33
- [Open/Closed center PVPV](#) on page 36

PVP Inlet Modules
Open Center PVP

The basic Open Center PVP inlet module is intended for use with fixed displacement pumps in applications, where a valve group with mechanically controlled work sections is desired, or where the pilot pressure to the valve group is supplied externally.

The Open Center PVP features:

- Integrated LS pressure relief valve
- Threaded ports for P/T/LS and M measuring gauge
- Optional LS unloading valve, PVPX
- Optional T0 facility and external T0 port
- Models with T0 port have internal T0 connection closed by default.

All modules can be manually activated with the PVM actuation.

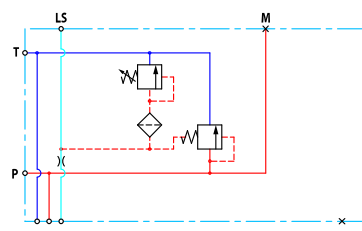
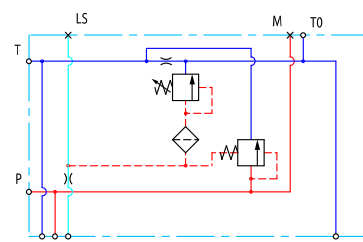
Open center PVP schematic

Open center PVP with T0

Technical specification for PVP

Max. P-port continuous	Max. P-port intermittent	Max. T-port static/dynamic	Max. rated flow
350 [5076 psi]	400 bar [5800 psi]	25/40 bar [365/580 psi]	140 l/min [37 US gal/min]

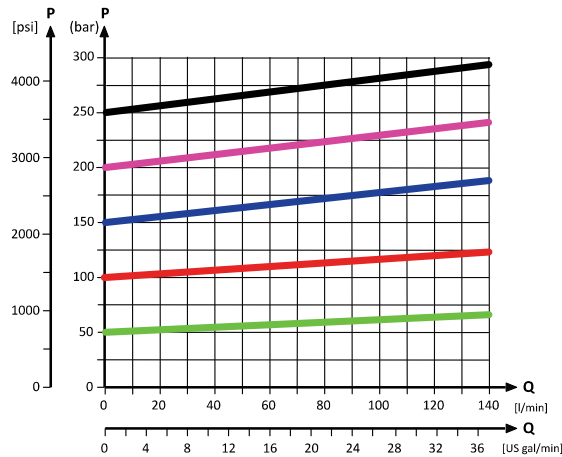
Technical specification

Parameter	Minimum	Recommended range	Maximum
Fluid temperature	-30°C [-22°F]	30 to 60°C [86 to 140°F]	90° [194°F]
Fluid viscosity	4 mm ² /s [39 SUS]	12 to 75 mm ² /s [65 to 347 SUS]	460 mm ² /s [2128 SUS]
Fluid cleanliness (mechanical activation)	23/19/16 (according to ISO 4406)		
Fluid cleanliness (PVE activation)	18/16/13 (according to ISO 4406)		
Operating temperature	Ambient: -30 to 60°C [-22 to 140°F]		

PVP Inlet Modules
Theoretical Performance Graphs
Integrated LS pressure relief valve characteristics

The LS pressure relief valve is adjusted at the Danfoss factory at 1.5l/min [0.396gal/min]. Depending on flow through the inlet, the set pressure will follow the curves as shown above.

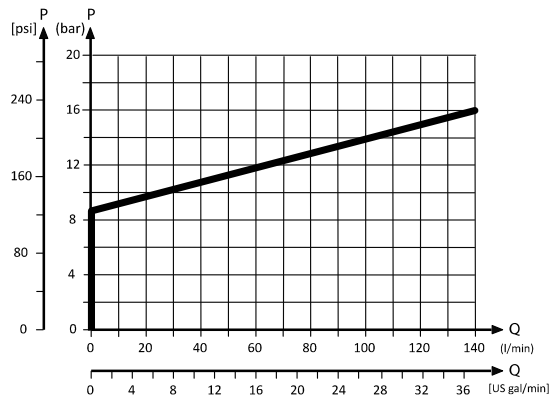
Neutral by-pass pressure drop characteristics

Part numbers for Open Center PVP

Part number	P-port	T-port	LS-, M-port (LS1**)	T0-port	Mounting	PVPX*
157B5000	G1/2"	G3/4"	G1/4"	-	M8	-
157B5100	G3/4"			-		-
157B5102	G3/4"			-		Yes
157B5200	7/8-14 UNF	1 1/16-12 UNF	1/2-20 UNF	-	5/16-18 UNC	-
157B5300	1-1/16 UN			-		-
11008852 ¹	G1/2	G3/4	G1/4 (G1/8)	-	M8	-
11030545	G3/4	G3/4	G1/4 (G1/4)	G1/4	M8	-
11053974	G3/4	G3/4	G1/4 (G1/4)	G1/4	M8	-
11151852	1 1/16-12 UNF	1 1/16-12 UNF	9/16-18 UNF	9/16-18 UNF	M8	-

Technical Information
PVG 32 Proportional Valve Group

PVP Inlet Modules
Part numbers for Open Center PVP (continued)

Part number	P-port	T-port	LS-, M-port (LS1 ^{**})	T0-port	Mounting	PVPX [*]
157B5908	1 1/16-12 UNF	1 1/16-12 UNF	1/2-20 UNF	-	M8	-
157B5921	JIS 1/2	JIS 3/4	JIS 1/4	-	M8	-
157B5925	JIS 3/4	JIS 3/4	JIS 1/4	-	M8	-
157B5945	G1/2	G3/4	G1/4 (G1/8)	-	M8	-
157B5990²	1 1/16-12 UNF	1 1/16-12 UNF	-	-	M8	-

^{**} LS1 is an extra LS-port.

^{*} For more information see [PVPX Electrical LS Pressure Unloading Valve](#) on page 39.

¹ Dampened LS response

² No relief valve

PVP Inlet Modules
Open Center PVP with PPRV

The Open Center PVP inlet with integrated pilot pressure reduction valve (PPRV) is intended for use with fixed displacement pumps in applications, where a valve group with electro-hydraulically or hydraulically controlled work sections is desired (PVE or PVH/PVHC).

The Open Center PVP with PPRV features:

- Integrated LS pressure relief valve
- Threaded ports for P/T/LS and M measuring gauge
- Integrated pilot pressure reducing valve (PPRV) for PVE or PVH/PVHC
- Optional T0 facility and external T0 port
- Optional external pilot pressure port (Pp)
- Optional LS unloading valve, PVPX
- Models with T0 port have internal T0 connection closed by default.

All modules can be manually activated with the PVM actuation.

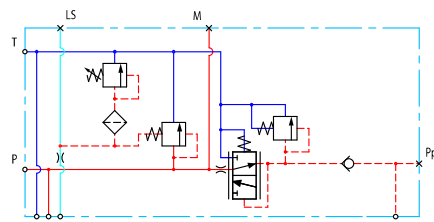
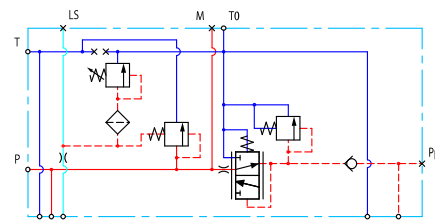
Open center PVP with PPRV schematic

Open center PVP with PPRV and T0

Technical specification for PVP

Max. P-port continuous	Max. P-port intermittent	Max. T-port static/ dynamic	Max. rated flow
350 [5076 psi]	400 bar [5800 psi]	25/40 bar [365/580 psi]	140 l/min [37 US gal/min]

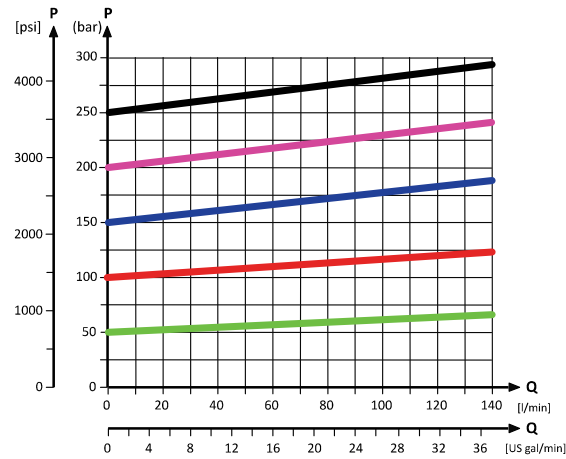
Technical specification

Parameter	Minimum	Recommended range	Maximum
Fluid temperature	-30°C [-22°F]	30 to 60°C [86 to 140°F]	90° [194°F]
Fluid viscosity	4 mm ² /s [39 SUS]	12 to 75 mm ² /s [65 to 347 SUS]	460 mm ² /s [2128 SUS]
Fluid cleanliness (mechanical activation)	23/19/16 (according to ISO 4406)		
Fluid cleanliness (PVE activation)	18/16/13 (according to ISO 4406)		
Operating temperature	Ambient: -30 to 60°C [-22 to 140°F]		

Technical Information
PVG 32 Proportional Valve Group
PVP Inlet Modules
Theoretical Performance Graphs
Integrated LS pressure relief valve characteristics

The LS pressure relief valve is adjusted at the Danfoss factory at 1.5l/min [0.396gal/min]. Depending on flow through the inlet, the set pressure will follow the curves as shown above.

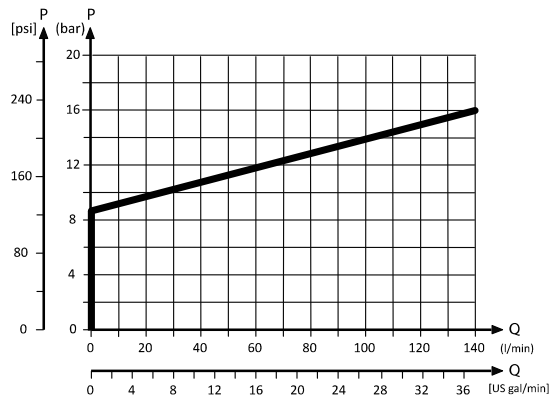
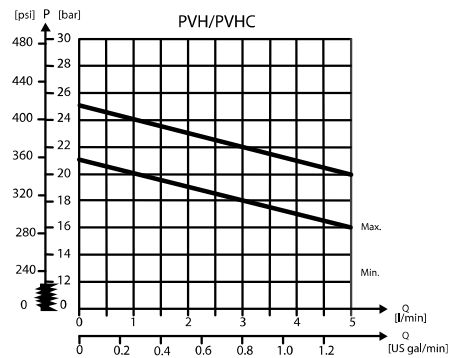
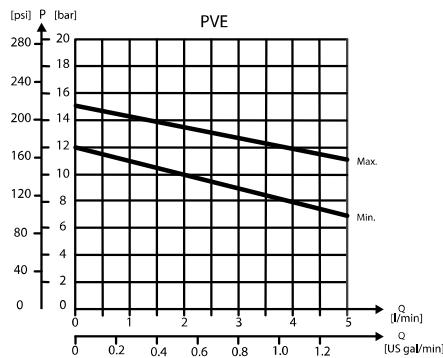
Neutral by-pass pressure drop characteristics

Pilot pressure reduction valve characteristics

Technical Information

PVG 32 Proportional Valve Group
PVP Inlet Modules
Part numbers for Open Center PVP with PPRV

Part number	Actuation	P-port	T-port	LS-port	M-port	Pp-port	T0-port	Mounting	PVPX*
11008849 ¹	PVE	G3/4"	G3/4"	G1/4"	G1/4"	-	-	M8	-
11008851 ¹	PVH/PVHC	G3/4"	G3/4"	G1/4"	G1/4"	G1/4"	-	M8	-
11066027	PVH/PVHC	G3/4"	G3/4"	G1/4"	G1/4"	-	-	M8	Yes
11072195	PVE	M27x2	M27x2	M14x1.5	M14x1.5	-	M14x1.5	M8	-
157B5010	PVE	G1/2"	G3/4"	G1/4"	G1/4"	-	-	M8	-
157B5012	PVE	G1/2"	G3/4"	G1/4"	G1/4"	-	-	M8	Yes
157B5110	PVE	G3/4"	G3/4"	G1/4"	G1/4"	-	-	M8	-
157B5112	PVE	G3/4"	G3/4"	G1/4"	G1/4"	-	-	M8	Yes
157B5130	PVE	G3/4"	G3/4"	G1/4"	G1/4"	G1/4"	G1/4"	M8	-
157B5132	PVE	G3/4"	G3/4"	G1/4"	G1/4"	G1/4"	G1/4"	M8	Yes
157B5180	PVE	G3/4"	G3/4"	G1/4"	G1/4"	G1/4"	-	M8	-
157B5190	PVH/PVHC	G3/4"	G3/4"	G1/4"	G1/4"	G1/4"	-	M8	-
157B5210	PVE	7/8-14 UNF	1 1/16-12 UNF	1/2-20 UNF	1/2-20 UNF	-	-	5/16-18 UNC	-
157B5212	PVE	7/8-14 UNF	1 1/16-12 UNF	1/2-20 UNF	1/2-20 UNF	-	-	5/16-18 UNC	Yes
157B5310	PVE	1 1/16-12 UNF	1 1/16-12 UNF	1/2-20 UNF	1/2-20 UNF	-	-	5/16-18 UNC	-
157B5312	PVE	1 1/16-12 UNF	1 1/16-12 UNF	1/2-20 UNF	1/2-20 UNF	-	-	5/16-18 UNC	Yes
157B5330	PVE	1 1/16-12 UNF	1 1/16-12 UNF	1/2-20 UNF	1/2-20 UNF	1/2-20 UNF	1/2-20 UNF	5/16-18 UNC	-
157B5332	PVE	1 1/16-12 UNF	1 1/16-12 UNF	1/2-20 UNF	1/2-20 UNF	-	-	5/16-18 UNC	Yes
157B5380	PVE	1 1/16-12 UNF	1 1/16-12 UNF	9/16-18 UNF	9/16-18 UNF	9/16-18 UNF	-	5/16-18 UNC	-
157B5390	PVH/PVHC	1 1/16-12 UNF	1 1/16-12 UNF	9/16-18 UNF	9/16-18 UNF	9/16-18 UNF	-	5/16-18 UNC	-
11101194	PVE	M22x1.5 M16x1.5 (P2)	M22x1.5	M12x1.5	M10x1	-	M16x1.5	M8	-
11008850	PVE	G3/4	G3/4	G1/4	G1/4	-	-	M8	Yes
11013317 ¹	PVE	G3/4	G3/4	G1/4	G1/4	G1/4	G1/4	M8	-
11020964	PVE	1 1/16-12 UNF	1 1/16-12 UNF	1/2-20 UNF	1/2-20 UNF	-	-	M8	-
11087590 ¹	PVH/PVHC	G3/4	G3/4	G1/4	G1/4	G1/4	-	M8	-
11090453	PVE	JIS 3/4	JIS 3/4	JIS 1/4	JIS 1/4	JIS 1/4	JIS 1/4	M8	-
11124965	PVH/PVHC	G3/4	G3/4	G1/4	G1/4	G1/4	G1/4	M8	Yes
11124966	PVH/PVHC	G3/4	G3/4	G1/4	G1/4	G1/4	G1/4	M8	-
111309412 ²	PVE	1 1/16-12 UNF	1 1/16-12 UNF	9/16-18 UNF	9/16-18 UNF	9/16-18 UNF	-	5/16-18 UNC	-
11167773	PVH/PVHC	1 1/16-12 UNF	1 1/16-12 UNF	1/2-20 UNF	1/2-20 UNF	-	-	5/16-18 UNC	Yes
11187356 ⁴	PVE	G1/2	G3/4	G1/4	G1/4	-	-	M8	Yes
11190123	PVH/PVHC	G1/2	G3/4	G1/4	G1/4	-	-	M8	Yes
11225941	PVE	1 1/16-12 UNF	1 1/16-12 UNF	9/16-18 UNF	9/16-18 UNF	9/16-18 UNF	9/16-18 UNF	5/16-18 UNC	-
157B5135 ³	PVE	G3/4	G3/4	G1/4	G1/4	G1/4	G1/4	M8	-
157B5904 ²	PVE	G3/4	G3/4	G1/4	G1/4	G1/4	-	M8	-
157B5923	PVE	JIS 1/2	JIS 3/4	JIS 1/4	JIS 1/4	-	-	M8	-
157B5926	PVE	JIS 3/4	JIS 3/4	JIS 1/4	JIS 1/4	-	-	M8	-
157B5934	PVE	G3/4	G3/4	G1/4	G1/4	-	-	M8	-

Technical Information
PVG 32 Proportional Valve Group
PVP Inlet Modules
Part numbers for Open Center PVP with PPRV (continued)

Part number	Actuation	P-port	T-port	LS-port	M-port	Pp-port	T0-port	Mounting	PVPX*
157B5943 ²	PVH/PVHC	G3/4	G3/4	G1/4	G1/4	G1/4	-	M8	-
157B5953 ²	PVE	G3/4	G3/4	G1/4	G1/4	-	-	M8	Yes
157B5954	PVE	G3/4	G3/4	G1/4	G1/4	G1/4	-	M8	-
157B5960	PVE	1 1/16-12 UNF	1 1/16-12 UNF	9/16-18 UNF	9/16-18 UNF	-	9/16-18 UNF	5/16-18 UNF	-
157B5966 ²	PVE	G3/4	G3/4	G1/4	G1/4	-	-	M8	Yes
157B5976	PVE	G3/4	G3/4	G1/4	G1/4	-	-	M8	Yes
157B5977 ^{1,4}	PVE	G3/4	G3/4	G1/4	G1/4	-	-	M8	-
11101194	PVE	M22 x 1.5	M22 x 1.5	M12 x 1.5	M10 x 1	-	M16 x 1.5	M8	-

* For more information please see the topic *PVPX Electrical LS Pressure Unloading Valve*.

¹ Dampened LS response

² Pressure adjustment spool with check valve

³ Internal T0 connection

⁴ Low flow pressure adjustment spool

PVP Inlet Modules
Open center PVP with HPCO and PVE PPRV

The Open Center PVP inlet with integrated High Pressure Carry Over (HPCO) functionality is intended for use with fixed displacement pumps in applications where one pump supply for multiple hydraulic subsystems is desired.

The integrated HPCO functionality guides the excess flow of the PVG 32 valve group to the external hydraulic subsystem(s), giving priority to the PVG 32 work functions.

The Open Center PVP with HPCO and PVE PPRV features:

- Integrated LS pressure relief valve
- Threaded ports for P/T/LS/HPCO and M measuring gauge
- Integrated pilot pressure reducing valve (PPRV) for PVE
- Optional T0 facility and external T0 port
- Optional external pilot pressure port (Pp)
- Optional LS unloading valve, PVPX
- Models with T0 port have internal T0 connection closed by default.

Only applicable with PVST end plates with separate T-port due to blocked T-lines for HPCO functionality.

Open center PVP with HPCO, PPRV, and T0

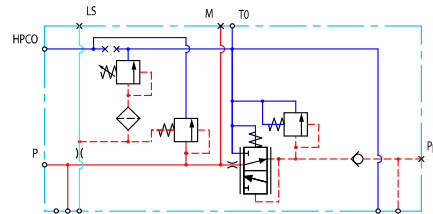

Technical specification for PVP

Max. P-port continuous	Max. P-port intermittent	Max. T-port static/ dynamic	Max. rated flow
350 [5076 psi]	400 bar [5800 psi]	25/40 bar [365/580 psi]	140 l/min [37 US gal/min]

Technical specification

Parameter	Minimum	Recommended range	Maximum
Fluid temperature	-30°C [-22°F]	30 to 60°C [86 to 140°F]	90° [194°F]
Fluid viscosity	4 mm ² /s [39 SUS]	12 to 75 mm ² /s [65 to 347 SUS]	460 mm ² /s [2128 SUS]
Fluid cleanliness (mechanical activation)	23/19/16 (according to ISO 4406)		
Fluid cleanliness (PVE activation)	18/16/13 (according to ISO 4406)		
Operating temperature	Ambient: -30 to 60°C [-22 to 140°F]		

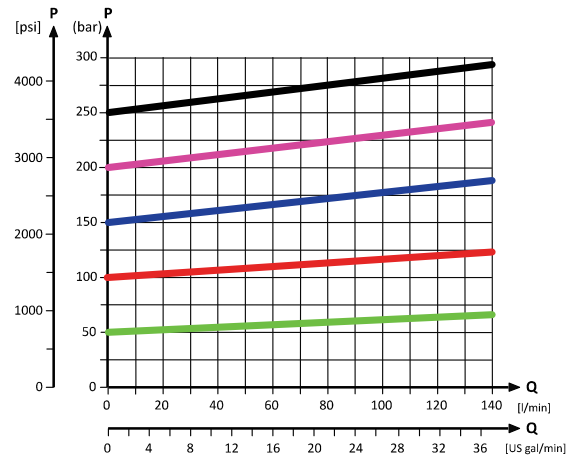
Technical Information
PVG 32 Proportional Valve Group
PVP Inlet Modules
Theoretical Performance Graphs
Integrated LS pressure relief valve characteristics

The LS pressure relief valve is adjusted at the Danfoss factory at 1.5l/min [0.396gal/min]. Depending on flow through the inlet, the set pressure will follow the curves as shown above.

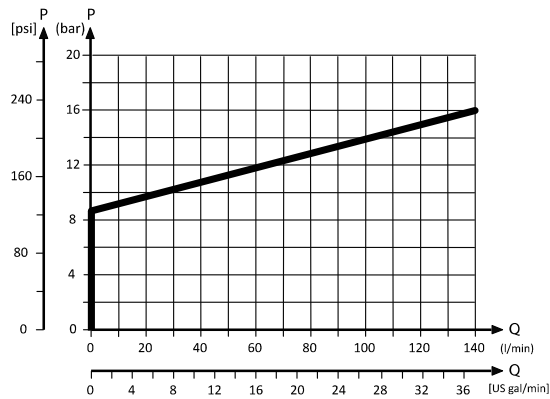
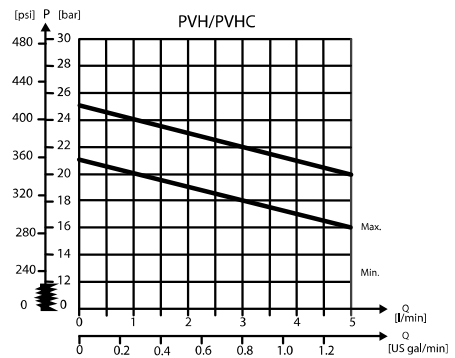
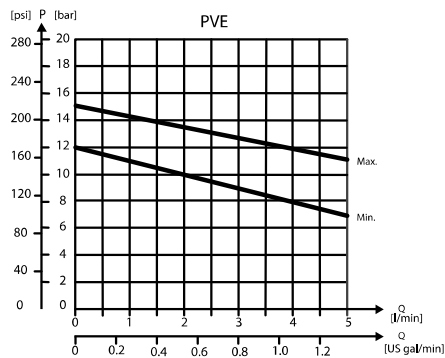
Neutral by-pass pressure drop characteristics

Pilot pressure reduction valve characteristics

Technical Information
PVG 32 Proportional Valve Group

PVP Inlet Modules
Part numbers for OC PVP (HPCO and PPRV)

Part number	P-port	HPCO-port	LS-port	M-port	Pp-port	T0-port	Mounting	PVPX*
157B5140	G3/4"	G3/4"	G1/4"	G1/4"	G1/4"	G1/4"	M8	-
157B5142	G3/4"	G3/4"	G1/4"	G1/4"	G1/4"	G1/4"	M8	Yes
157B5340	1 1/16-12 UNF	1 1/16-12 UNF	1/2-20 UNF	1/2-20 UNF	1/2-20 UNF	1/2-20 UNF	5/16-18 UNC	-
157B5342	1 1/16-12 UNF	1 1/16-12 UNF	1/2-20 UNF	1/2-20 UNF	1/2-20 UNF	-	5/16-18 UNC	Yes
157B5961	M27x2	M27x2	M14x1.5	M14x1.5	-	M14x1.5	M8	-
11101195	M22x1.5 M16x1.5 (P2)	M22x1.5	M12x1.5	M10x1	-	M16x1.5	M8	-

* For more information please see the topic *PVPX Electrical LS Pressure Unloading Valve*.

Technical Information
PVG 32 Proportional Valve Group
PVP Inlet Modules
Closed Center PVP

The basic Closed Center PVP inlet is intended for use with variable displacement pumps in applications where a valve group with mechanically controlled work sections is desired, or where the pilot pressure to the valve group is supplied externally.

The Closed Center PVP features:

- Integrated LS pressure relief valve
- Threaded ports for P/T/LS and M measuring gauge
- Optional LS unloading valve, PVPX
- Optional T0 facility and external T0 port
- Models with T0 port have internal T0 connection closed by default.

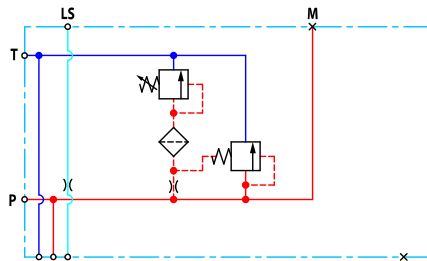
Closed center PVP schematic

Technical specification for PVP

Max. P-port continuous	Max. P-port intermittent	Max. T-port static/dynamic	Max. rated flow
350 [5076 psi]	400 bar [5800 psi]	25/40 bar [365/580 psi]	140 l/min [37 US gal/min]

Technical specification

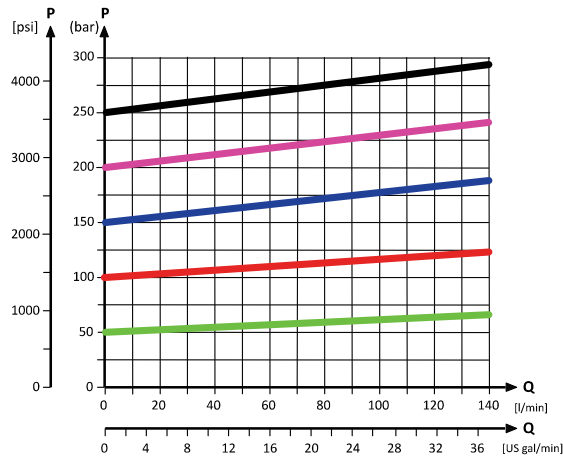
Parameter	Minimum	Recommended range	Maximum
Fluid temperature	-30°C [-22°F]	30 to 60°C [86 to 140°F]	90° [194°F]
Fluid viscosity	4 mm ² /s [39 SUS]	12 to 75 mm ² /s [65 to 347 SUS]	460 mm ² /s [2128 SUS]
Fluid cleanliness (mechanical activation)	23/19/16 (according to ISO 4406)		
Fluid cleanliness (PVE activation)	18/16/13 (according to ISO 4406)		
Operating temperature	Ambient: -30 to 60°C [-22 to 140°F]		

PVP Inlet Modules
Theoretical Performance Graphs
Integrated LS pressure relief valve characteristics

The LS pressure relief valve is adjusted at the Danfoss factory at 1.5l/min [0.396gal/min]. Depending on flow through the inlet, the set pressure will follow the curves as shown above.

Part numbers for Closed Center PVP

Part number	P-port	T-port	LS-port (LS1 ^{**})	M-port	T0-port	Mounting	PVPX [*]
11030683	G3/4	G3/4	G1/4 (G1/4)	G1/4	G1/4	M8	-
157B5001	G1/2	G3/4	G1/4	G1/4	-	M8	-
157B5101	G3/4	G3/4	G1/4	G1/4	-	M8	-
157B5103	G3/4	G3/4	G1/4	G1/4	-	M8	Yes
157B5201	7/8-14 UNF	1 1/16-12 UNF	1/2-20 UNF	1/2-20 UNF	--	5/16-18 UNC	-
157B5301	1 1/16-12 UNF	1 1/16-12 UNF	1/2-20 UNF	1/2-20 UNF	-	5/16-18 UNC	-
15B5907	1 1/16-12 UNF	1 1/16-12 UNF	1/2-20 UNF	1/2-20 UNF	-	M8	-
157B5922	JIS 1/2	JIS 3/4	JIS 1/4	JIS 1/4	-	M8	-
157B5927	JIS 3/4	JIS 3/4	JIS 1/4	JIS 1/4	-	M8	-
157B5946	G1/2	G3/4	G1/4 (G1/8)	G1/4	-	M8	-

^{**} LS1 is an extra LS-port

^{*} For more information see [PVPX Electrical LS Pressure Unloading Valve](#) on page 39

PVP Inlet Modules
Closed Center PVP with PPRV

The Closed Center PVP inlet with integrated pilot pressure reduction valve (PPRV) is intended for use with variable displacement pumps in applications where a valve group with electro-hydraulic or hydraulically controlled work sections is desired.

The Closed Center PVP with PPRV features:

- Integrated LS pressure relief valve
- Threaded ports for P/T/LS and M measuring gauge
- Integrated pilot pressure reducing valve (PPRV) for PVE or PVH/PVHC
- Optional T0 facility and external T0 port
- Optional LS unloading valve, PVPX
- Models with T0 port have internal T0 connection closed by default.

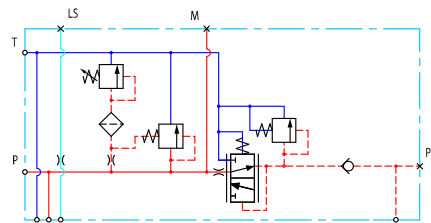
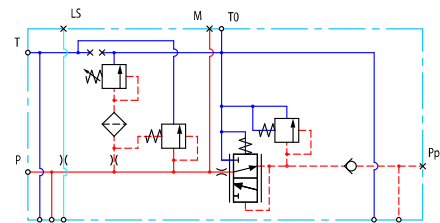
Closed center PVP with PPRV schematic

Closed center PVP with PPRV and T0

Technical specification for PVP

Max. P-port continuous	Max. P-port intermittent	Max. T-port static/ dynamic	Max. rated flow
350 [5076 psi]	400 bar [5800 psi]	25/40 bar [365/580 psi]	140 l/min [37 US gal/min]

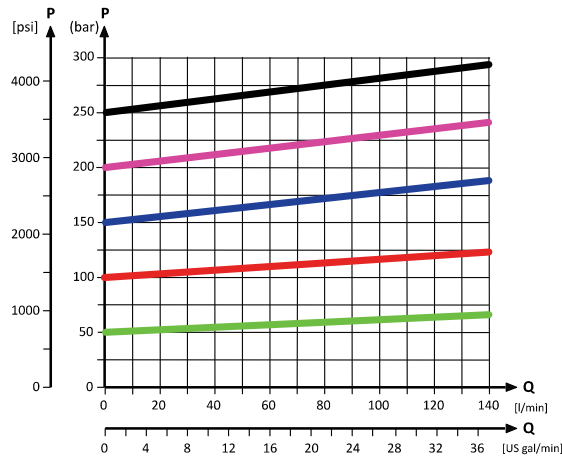
Technical specification

Parameter	Minimum	Recommended range	Maximum
Fluid temperature	-30°C [-22°F]	30 to 60°C [86 to 140°F]	90° [194°F]
Fluid viscosity	4 mm ² /s [39 SUS]	12 to 75 mm ² /s [65 to 347 SUS]	460 mm ² /s [2128 SUS]
Fluid cleanliness (mechanical activation)	23/19/16 (according to ISO 4406)		
Fluid cleanliness (PVE activation)	18/16/13 (according to ISO 4406)		
Operating temperature	Ambient: -30 to 60°C [-22 to 140°F]		

Technical Information
PVG 32 Proportional Valve Group
PVP Inlet Modules
Theoretical Performance Graphs
Integrated LS pressure relief valve characteristics

The LS pressure relief valve is adjusted at the Danfoss factory at 1.5l/min [0.396gal/min]. Depending on flow through the inlet, the set pressure will follow the curves as shown above.

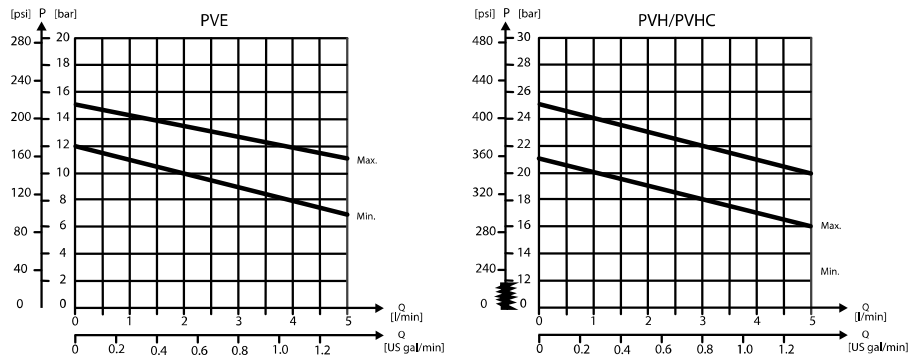
Pilot pressure reduction valve characteristics

Part numbers for Closed Center PVP with PPRV

Part number	Actuation	P-port	T-port	LS-port (LS1**)	M-port	Pp-port	T0-port	Mounting	PVPX*
11051802	PVH/PVHC	1 1/16-12 UNF	1 1/16-12 UNF	1/2-20 UNF	1/2-20 UNF	1/2-20 UNF	1/2-20 UNF	5/16-18 UNC	-
157B5011	PVE	G1/2"	G3/4"	G1/4"	G1/4"	-	-	M8	-
157B5013	PVE	G1/2"	G3/4"	G1/4"	G1/4"	-	-	M8	Yes
157B5111	PVE	G3/4"	G3/4"	G1/4"	G1/4"	-	-	M8	-
157B5113	PVE	G3/4"	G3/4"	G1/4"	G1/4"	-	-	M8	Yes
157B5131	PVE	G3/4"	G3/4"	G1/4"	G1/4"	G1/4"	G1/4"	M8	-
157B5133	PVE	G3/4"	G3/4"	G1/4"	G1/4"	G1/4"	G1/4"	M8	Yes
157B5181	PVE	G3/4"	G3/4"	G1/4"	G1/4"	G1/4"	-	M8	-
157B5191	PVH/PVHC	G3/4"	G3/4"	G1/4"	G1/4"	G1/4"	-	M8	-

Technical Information
PVG 32 Proportional Valve Group
PVP Inlet Modules
Part numbers for Closed Center PVP with PPRV (continued)

Part number	Actuation	P-port	T-port	LS-port (LS1)**	M-port	Pp-port	T0-port	Mounting	PVPX*
157B5211	PVE	7/8-14 UNF	1 1/16-12 UNF	1/2-20 UNF	1/2-20 UNF	-	-	5/16-18 UNC	-
157B5213	PVE	7/8-14 UNF	1 1/16-12 UNF	1/2-20 UNF	1/2-20 UNF	-	-	5/16-18 UNC	Yes
157B5311	PVE	1 1/16-12 UNF	1 1/16-12 UNF	1/2-20 UNF	1/2-20 UNF	-	-	5/16-18 UNC	-
157B5313	PVE	1 1/16-12 UNF	1 1/16-12 UNF	1/2-20 UNF	1/2-20 UNF	-	-	5/16-18 UNC	Yes
157B5331	PVE	1 1/16-12 UNF	1 1/16-12 UNF	1/2-20 UNF	1/2-20 UNF	1/2-20 UNF	1/2-20 UNF	5/16-18 UNC	-
157B5333	PVE	1 1/16-12 UNF	1 1/16-12 UNF	1/2-20 UNF	1/2-20 UNF	1/2-20 UNF	1/2-20 UNF	5/16-18 UNC	Yes
157B5381	PVE	1 1/16-12 UNF	1 1/16-12 UNF	9/16-18 UNF	9/16-18 UNF	9/16-18 UNF	-	5/16-18 UNC	-
157B5391	PVH/PVHC	1 1/16-12 UNF	1 1/16-12 UNF	9/16-18 UNF	9/16-18 UNF	9/16-18 UNF	-	5/16-18 UNC	-

** LS1 is an extra LS-port

 * For more information please see [PVPX Electrical LS Pressure Unloading Valve](#) on page 39

All modules can be manually activated with the PVM actuation.

Technical Information
PVG 32 Proportional Valve Group
PVP Inlet Modules
Closed Center PVPV

The Closed Center PVPV inlet is intended for use with variable displacement pumps in applications where a valve group with mechanical controlled work sections is desired.

The Closed Center PVPV features:

- Optional T0 facility and external T0 port
- Threaded ports for P/T/LS and M measuring gauge
- Optional additional threaded ports for P2, T2, and T02
- Models with T0 port have internal T0 connection closed by default.

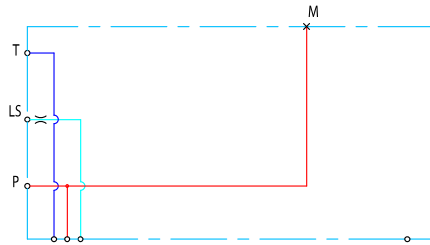
Closed Center PVPV schematic

Technical specification

Parameter	Minimum	Recommended range	Maximum
Fluid temperature	-30°C [-22°F]	30 to 60°C [86 to 140°F]	90° [194°F]
Fluid viscosity	4 mm ² /s [39 SUS]	12 to 75 mm ² /s [65 to 347 SUS]	460 mm ² /s [2128 SUS]
Fluid cleanliness (mechanical activation)	23/19/16 (according to ISO 4406)		
Fluid cleanliness (PVE activation)	18/16/13 (according to ISO 4406)		
Operating temperature	Ambient: -30 to 60°C [-22 to 140°F]		

Part number	P-port (P2)	T-port (T2)	LS-port	M-port	T0-port (T02)	Mounting
11055758	M27x2.0 (M27x2.0)	M27x2.0 (M14x1.5)	M14x1.5	M14x1.5	M14x1.5 (M14x1.5)	M8
11067570	M27x2.0	M33x2.0	M14x1.5	M14x1.5	-	M8

Technical Information
PVG 32 Proportional Valve Group
PVP Inlet Modules
Closed center PVPV with PPRV

The Closed Center PVPV inlet with integrated pilot pressure reduction valve (PPRV) is intended for use with variable displacement pumps in applications where a valve group with electro-hydraulic or hydraulically controlled work sections is desired.

The Closed Center PVPV with PPRV features:

- Optional shock/anti-cavitation valve facility (PVLP)
- Threaded ports for P/T/LS and M measuring gauge
- Integrated pilot pressure reducing valve (PPRV) for PVE or PVH/PVHC
- Models with T0 port have internal T0 connection closed by default.

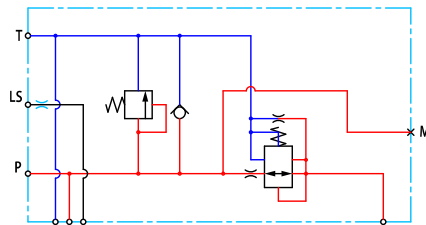
Hydraulic schematic

Technical specification for PVP

Max. P-port continuous	Max. P-port intermittent	Max. T-port static/dynamic	Max. rated flow
350 [5076 psi]	400 bar [5800 psi]	25/40 bar [365/580 psi]	150 l/min [37 US gal/min]

Technical specification

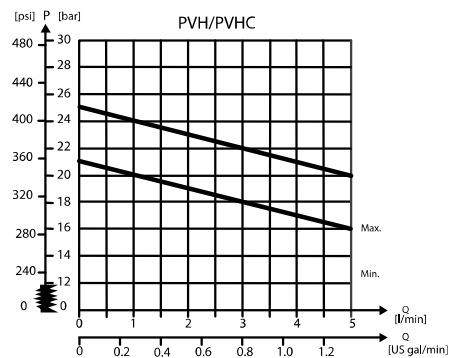
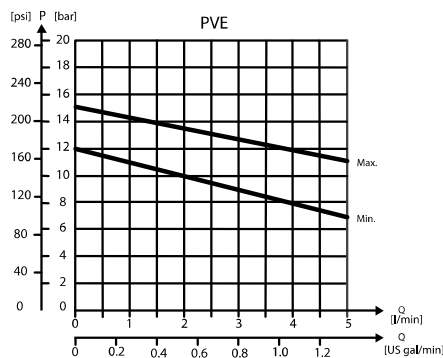
Parameter	Minimum	Recommended range	Maximum
Fluid temperature	-30°C [-22°F]	30 to 60°C [86 to 140°F]	90° [194°F]
Fluid viscosity	4 mm ² /s [39 SUS]	12 to 75 mm ² /s [65 to 347 SUS]	460 mm ² /s [2128 SUS]
Fluid cleanliness (mechanical activation)	23/19/16 (according to ISO 4406)		
Fluid cleanliness (PVE activation)	18/16/13 (according to ISO 4406)		
Operating temperature	Ambient: -30 to 60°C [-22 to 140°F]		

Pilot pressure reduction valve characteristics

Technical Information

PVG 32 Proportional Valve Group
PVP Inlet Modules

Part numbers for Closed Center PVPV with PPRV

Part number	Actuator	P-port	T-port (T2)	LS-port	M-port	Pp-port	T0-port (T02)	Mounting	PVLP	
11012350 ¹	PVE	M27x2.0	M33x2.0	M14x1.5	M14x1.5	-	-	M8	-	
11003806		M27x2.0	M27x2.0 (M14x1.5)	M14x1.5	M14x1.5	-	M14x1.5 (M14x1.5)	M8	-	
11008854 ²		G1	G1	G1/4	G1/4	-	-	M8	Yes	
11124107 ²		1 5/16-12	1 1/16-12	9/16-18	9/16-18	-	-	M8	Yes	
11196949		G1	G1	-	-	G1/4	-	M8	Yes	
157B5911		1 5/16-12	1 5/16-12	9/16-18	9/16-18	-	-	5/16-18	-	
157B5913		1 5/16-12	1 5/16-12	9/16-18	9/16-18	-	-	5/16-18	Yes	
157B5938		G1	G1	G1/4	G1/4	-	-	M8	-	
157B5941		G1	G1	G1/4	G1/4	-	-	M8	Yes	
157B5948 ³		G1	G1	G1/4	G1/4	-	-	M8	Yes	
157B5973 ⁴		G1	G1	G1/4	G1/4	-	-	M8	Yes	
157B5978		M27x2.0	M33x2.0	M14x1.5	M14x1.5	-	-	M8	-	
11008856		PVH/PVHC	G1	G1	G1/4	G1/4	-	-	M8	Yes
11051803 ³			1 5/16-12	1 5/16-12	9/16-18	9/16-18	-	-	5/16-18	Yes
157B5916			1 5/16-12	1 5/16-12	9/16-18	9/16-18	-	-	5/16-18	-

¹ No LS-orifice

² Internal T0 connection

³ 0.4 mm hole in the pilot reduction cone (standard 0.8 mm)

⁴ HPCO-facility

All modules can be manually activated with the PVM actuation.

PVP Inlet Modules
Open/Closed center PVP with PPRV

The Open Center/Closed Center PVP with integrated pilot pressure reduction valve (PPRV) is intended for use with fixed or variable displacement pumps in applications where the application manufacturer does not determine the pump type.

The modules allow an easy switch between Open Center and Closed Center configuration by means of an external hexagon selector key. Variants also feature an LS boost functionality, increasing the LS pressure to the pump LS regulator with a constant 6 bar, compensating for potential LS bleed-off and leakage.

The Open/closed center PVP with PPRV features:

- Integrated OC/CC selector
- Integrated LS pressure relief valve
- Threaded ports for P/T/LS and M measuring gauge
- Integrated pilot pressure reducing valve (PPRV) for PVE or PVH/PVHC
- Optional LS boost functionality

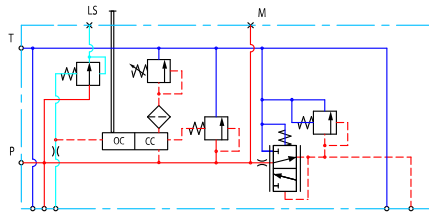
Hydraulic schematic

Technical specification for PVP

Max. P-port continuous	Max. P-port intermittent	Max. T-port static/ dynamic	Max. rated flow
350 [5076 psi]	400 bar [5800 psi]	25/40 bar [365/580 psi]	140 l/min [37 US gal/min]

Technical specification

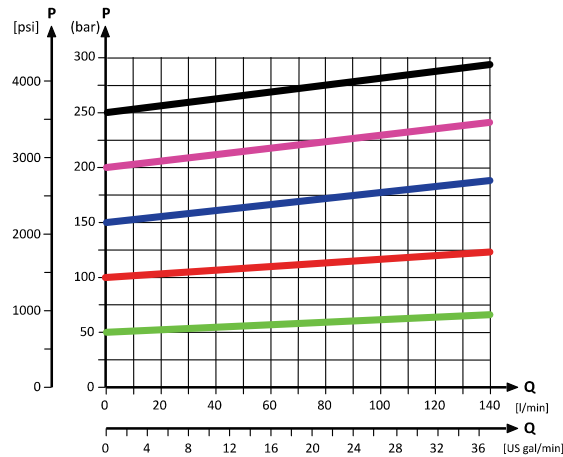
Parameter	Minimum	Recommended range	Maximum
Fluid temperature	-30°C [-22°F]	30 to 60°C [86 to 140°F]	90° [194°F]
Fluid viscosity	4 mm ² /s [39 SUS]	12 to 75 mm ² /s [65 to 347 SUS]	460 mm ² /s [2128 SUS]
Fluid cleanliness (mechanical activation)	23/19/16 (according to ISO 4406)		
Fluid cleanliness (PVE activation)	18/16/13 (according to ISO 4406)		
Operating temperature	Ambient: -30 to 60°C [-22 to 140°F]		

Technical Information
PVG 32 Proportional Valve Group
PVP Inlet Modules
Theoretical Performance Graphs
Integrated LS pressure relief valve characteristics

The LS pressure relief valve is adjusted at the Danfoss factory at 1.5l/min [0.396gal/min]. Depending on flow through the inlet, the set pressure will follow the curves as shown above.

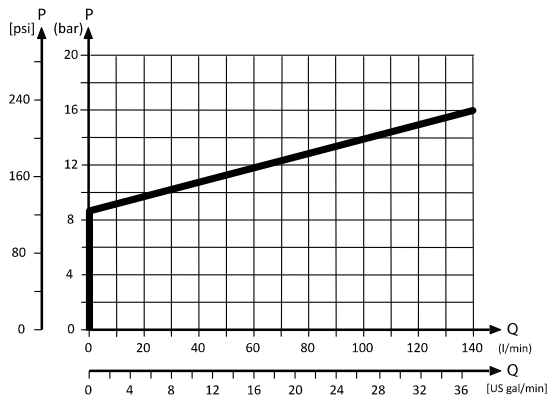
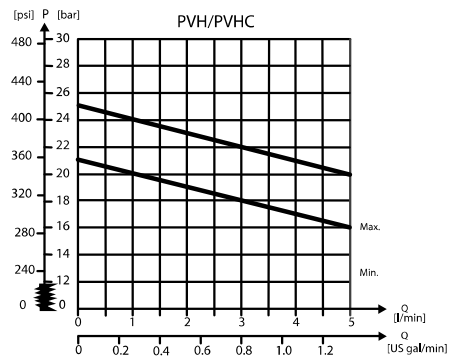
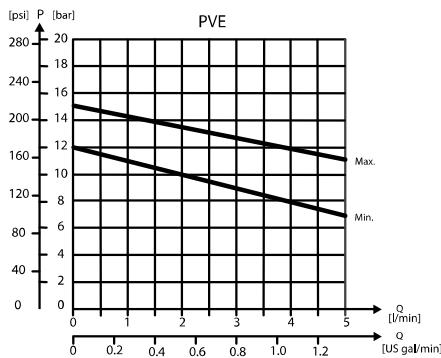
Neutral by-pass pressure drop characteristics

Pilot pressure reduction valve characteristics

Technical Information
PVG 32 Proportional Valve Group

PVP Inlet Modules
Part numbers for Open/Closed Center PVP with PPRV

Part number	Actuation	P-port	T-port	LS-port (LS1 ^{**})	M-port	T0-port	Mounting	LS Boost
11093273	PVE	G3/4	G3/4	-	G1/4	-	M8	Yes
11119094	PVE	G3/4	G3/4	-	G1/4	-	M8	-
11119095	PVE	1 1/16-12 UNF	1 1/16-12 UNF	1/2-20 UNF	1/2-20 UNF	-	M8	-
11131344	PVH/PVHC	G3/4	G3/4	-	G1/4	-	M8	Yes
11168608 ¹	PVE	G3/4	G3/4	-	G1/4	-	M8	Yes

^{**} LS1 is an extra LS-port

¹ Dampened LS response

All modules can be manually activated with the PVM actuation.

PVP Inlet Modules
Open/Closed center PVPM

The Open Center/Closed Center PVPM mid-inlet acts as a simple manifold and is intended for use with fixed or variable displacement pumps. The PVPM features no logic other than a PVLP shock/anti-cavitation valve facility for pressure peak protection and anti-cavitation prevention.

The PVPM module must be configured together with an Open Center PVP module for **fixed displacement pumps** and for **variable displacement pumps** can be configured together with a PVSI start plate or a Closed Center PVP/PVPV module.

The Open center/closed center PVPM features:

- Integrated shock/anti-cavitation valve facility (PVLP)
- Threaded ports for P/T
- Pilot pressure and T0 lines through module

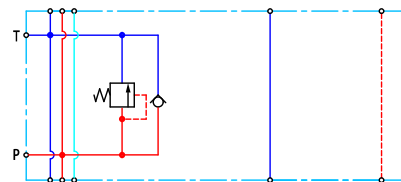
Hydraulic schematic

Technical specification for PVP

Max. P-port continuous	Max. P-port intermittent	Max. T-port static/dynamic	Max. rated flow
350 [5076 psi]	400 bar [5800 psi]	25/40 bar [365/580 psi]	230 l/min [61 US gal/min]

Technical specification

Parameter	Minimum	Recommended range	Maximum
Fluid temperature	-30°C [-22°F]	30 to 60°C [86 to 140°F]	90° [194°F]
Fluid viscosity	4 mm ² /s [39 SUS]	12 to 75 mm ² /s [65 to 347 SUS]	460 mm ² /s [2128 SUS]
Fluid cleanliness (mechanical activation)	23/19/16 (according to ISO 4406)		
Fluid cleanliness (PVE activation)	18/16/13 (according to ISO 4406)		
Operating temperature	Ambient: -30 to 60°C [-22 to 140°F]		

Part numbers for Open Center/Closed Center PVPM

Part number	P-, T-port	Mounting	PVLP
11093682	1 5/16-12 UN	5/16-18 UNC	Yes
11093684	G1"	M8	Yes

Technical Information
PVG 32 Proportional Valve Group
PVP Inlet Modules
Open/closed center CC selector
Technical Data

Maximum pressure	P-port continuous	350 bar [5075 psi]
	P-port intermittent	400 bar [5800 psi]
	T-port static/dynamic	25/40 bar [365/580 psi]
Oil flow rated P-port		140 l/min [37 US gal/min]

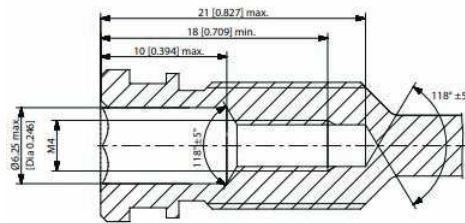
OC/CC selector

Changed using a 6 mm hexagonal key.

Turned clockwise (screw in) equals **Open Center configuration**. The oil then flows from the pump through the P-port in the PVP OC/CC module across the main spool to tank. The oil led across the pressure adjustment spool determines the pump pressure. When one or more sections in the valve stack is being actuated, the highest load pressure is fed to the spring chamber behind the pressure adjustment spool and completely or partially closes the connection to tank.

Turned counter-clockwise (screw out) equals **Closed Center configuration**. The oil still enters through the P-port in the PVP OC/CC module but the pressure adjustment spool will only open to tank when the P-channel pressure exceeds the setting of the pressure relief valve. The LS signal is led to the pump regulator through the LS-port connection.

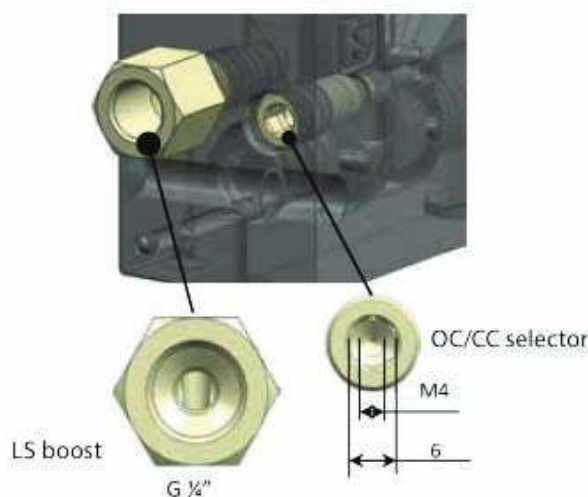

LS boost

The LS to the pump regulator can be increased by using an integrated LS boost. The LS signal coming out of the plug will be 6 bar higher than the actual LS pressure in the valve stack.

Technical Information
PVG 32 Proportional Valve Group

PVP Inlet Modules

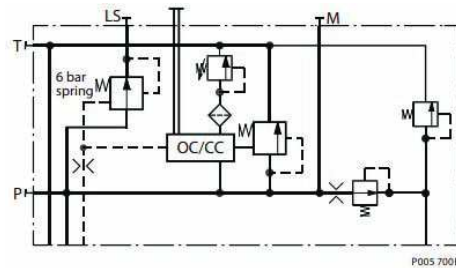
Schematic



Technical Information
PVG 32 Proportional Valve Group
PVP Inlet Module Accessories

The generic PVP inlet module accessory platform includes the PVPX Electrical LS pressure unloading valve, External pilot pressure adapters PVPC with or without check valve for all Open Center PVP with PPRV.

- [PVPX Electrical LS Pressure Unloading Valve](#) on page 39
- [PVPC without Check Valve](#) on page 42
- [PVPC with Check Valve](#) on page 44

PVPX Electrical LS Pressure Unloading Valve

The electrical LS pressure unloading valve is an accessory available for PVP inlet modules with PVPX facility. The PVPX consist of a solenoid valve and a magnetic coil package, allowing the operator to relieve the LS pressure to tank electrically.

Configuration variants also feature a Manual Override functionality to activate the PVPX manually:

- Normally Open (NO),
- Normally Open with Manual Override (NOMO)

There are two types of NOMO-configurations - PUSH, and PUSH & TURN. With the TURN function you can keep the override function until you unlock it again.

- Normally Closed (NC)

Configuration variants

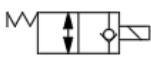
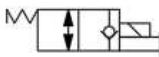
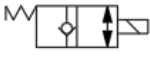
Normally Open (NO)	Normally Open with MOR (NOMO)	Normally Closed (NC)
		

Relieving the LS pressure to tank results in a reduced system pressure level, which is determined by:

- the sum of the tank and neutral by-pass pressure drop in a **Open Center** PVP configuration
- the sum of the tank and standby-pressure in a **Closed Center** PVP configuration

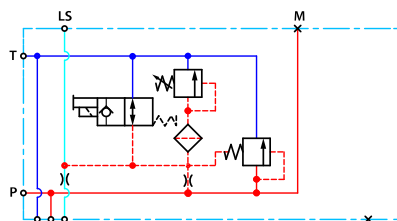
PVPX with NOMO schematic

PVPX technical data

Voltage supply	12/24 V _{DC} ± 10%
Resistance @ 12 V_{DC}	7.2 Ω ± 7%
Resistance @ 24 V_{DC}	28.2 Ω ± 7%
Power consumption	20 W
Maximum LS response time	300 ms
Max. pressure drop @ 0.1 l/min [2.6 US gal/min]	2 bar [30 psi]

Technical Information
PVG 32 Proportional Valve Group
PVP Inlet Module Accessories
PVPX technical data (continued)

Max. coil surface temperature	155°C [311°F]
Thread size	3/4-16 UNF

Technical specification

Parameter	Minimum	Recommended range	Maximum
Fluid temperature	-30°C [-22°F]	30 to 60°C [86 to 140°F]	90° [194°F]
Fluid viscosity	4 mm ² /s [39 SUS]	12 to 75 mm ² /s [65 to 347 SUS]	460 mm ² /s [2128 SUS]
Fluid cleanliness (mechanical activation)	23/19/16 (according to ISO 4406)		
Fluid cleanliness (PVE activation)	18/16/13 (according to ISO 4406)		
Operating temperature	Ambient: -30 to 60°C [-22 to 140°F]		

Part numbers for PVPX
Part numbers for PVPX, NO and NC configuration

Part number	Configuration	Voltage Supply	Connector	IP Rating
157B4236	NO	12 V _{DC}	1x2 DIN	IP 65
157B4238	NO	24 V _{DC}		
157B4246	NC	12 V _{DC}		
157B4248	NC	24 V _{DC}		
157B4976	NC	26 V _{DC}		
157B4981	NO	12 V _{DC}	1x2 AMP	IP 66
157B4982	NO	24 V _{DC}		
157B4983	NC	12 V _{DC}		
157B4984	NC	24 V _{DC}		
11180766	NO	12 V _{DC}	1x2 DEUTSCH	IP 67
11180767	NO	24 V _{DC}		
11180768	NC	12 V _{DC}		
11180769	NC	24 V _{DC}		
11225108	NO	26 V _{DC}		
11225109	NC	26 V _{DC}		

Part numbers for PVPX, NOMO configuration

Part number	Manual Override	Voltage Supply	Connector	IP Rating
157B4256	PUSH	12 V _{DC}	1x2 DIN	IP 65
157B4257	PUSH & TURN	12 V _{DC}		
157B4258	PUSH	24 V _{DC}		
157B4259	PUSH & TURN	24 V _{DC}		
157B4260	PUSH	26 V _{DC}		

Technical Information
PVG 32 Proportional Valve Group
PVP Inlet Module Accessories
Part numbers for PVPX, NOMO configuration (continued)

Part number	Manual Override	Voltage Supply	Connector	IP Rating
157B4985	PUSH	12 V _{DC}	1x2 AMP	IP 66
157B4986	PUSH	24 V _{DC}		
11193839	PUSH	12 V _{DC}	1x2 DEUTSCH	IP 67
11193836	PUSH	24 V _{DC}		
11225111	PUSH	26 V _{DC}		
11225110	PUSH & TURN			

Part number for plug in PVPX port

Part number	Description
157B5601	Plug

PVP Inlet Module Accessories

PVPC without Check Valve

The PVPC external pilot pressure adapter without check valve is an accessory in the M-port available for PVP inlet modules with integrated pilot pressure reduction valve (PPRV).

The PVPC without check valve cuts off the integrated PPRV to the PVE or PVH/PVHC in the valve group and enables an external pilot pressure supply through the PVPC adapter.

PVPC without Check Valve

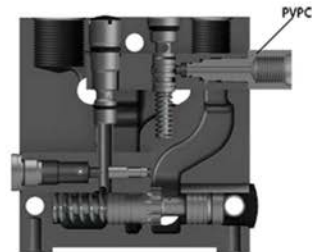

One application example for the PVPC without check valve is where it is a wanted feature to supply the valve group with oil from a manually operated emergency pump without directing oil flow to the PPRV.

When the main pump is running in its normal operation mode, the oil is directed through the PVPC adapter via the PPRV to the PVE electrical actuators.

When the main pump flow fails, the external shuttle valve ensures that the oil flow from the manually operated emergency pump is used to pilot open the over-center valve and lower the load. The load is only possible to lower when using the mechanical operating lever of the PVG work sections.

Part number for PVPC without Check Valve

Part number	157B5400
Thread	G1/4"

Technical Information
PVG 32 Proportional Valve Group

PVP Inlet Module Accessories

Hydraulic diagram for PVPC without check valve

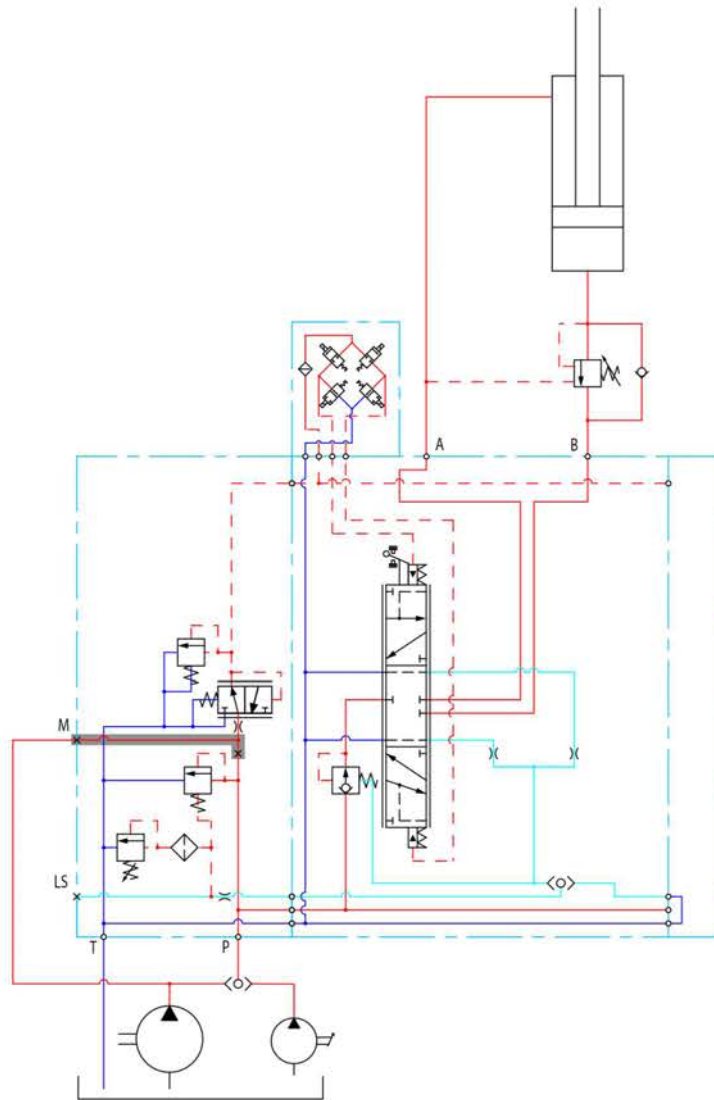

PVP Inlet Module Accessories
PVPC with Check Valve

The PVPC external pilot pressure adapter with check valve is an accessory in the M-port available for PVP inlet modules with integrated pilot pressure reduction valve (PPRV).

The PVPC with check valve enables an external pilot pressure supply through the PVPC adapter and the PPRV, while also allowing the main pump to supply the PPRV through the P-gallery as a standard Open Center PVP with PPRV.

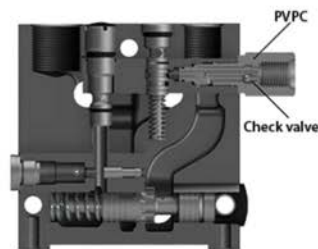
PVPC with Check Valve

One application example for the PVPC with check valve is where it is a wanted feature to operate the valve group by means of the PVE electrical actuators without pump flow.

When the external solenoid valve is opened, oil from the pressure side of the cylinder is fed via the PVPC through the PPRV to act as the pilot supply for the PVE electrical actuators. This means that it is possible to lower a load by means of the PVE electrical actuators without starting the pump.

The built-in check valve prevents the oil from flowing via the pressure adjustment spool to tank. With the pump functioning normally the external solenoid valve is closed to ensure that the load is not lowered due to the pilot supply oil flow requirement of approximately 1 l/min [0.25 US gal/min].

With a Closed Center PVP the external pilot oil supply can be connected to the pressure gauge connection without the use of a PVPC plug.

Part numbers for PVPC with Check Valve

Part number	157B5600	157B5700
Thread	G1/4"	1/2-20 UNF

Technical Information
PVG 32 Proportional Valve Group

PVP Inlet Module Accessories

Hydraulic diagram for PVPC with check valve

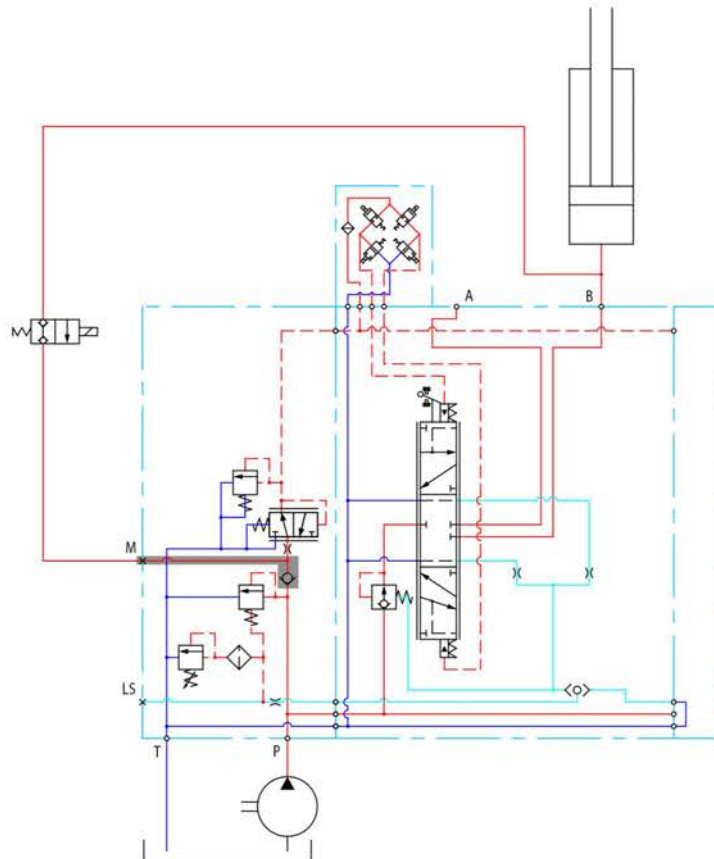

PVB Basic Modules

The PVG 32 PVB basic modules, also referred to as work sections, are the interface between the PVG 32 proportional valve group and the work function such as a cylinder or a motor.

PVB Basic Module

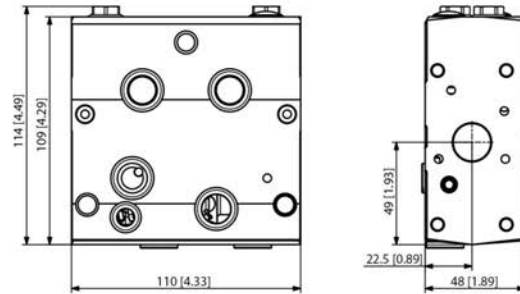
PVB 32 dimensions

Weight: 3.05 kg [6.73 lb]

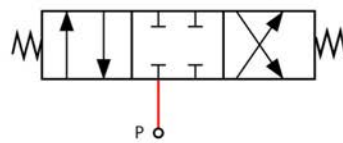
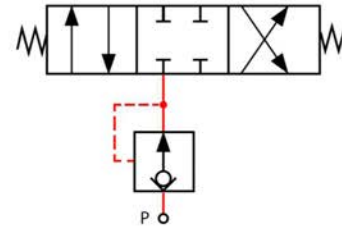
Uncompensated PVB schematic symbol

Compensated PVB schematic symbol

The PVB basic module variants are based on a generic platform with a selection of additional features, enabling you to tailor the PVB to suit the demands of any hydraulic system. The generic PVB basic module platform includes the following main variants:

- [Uncompensated PVB](#) on page 47
- [Uncompensated PVB with load drop check valve](#) on page 50
- [Uncompensated PVBZ with POC](#) on page 53
- [Compensated PVB](#) on page 54
- [Dampened Compensated PVB](#) on page 57
- [Dampened compensated PVB with LS A/B](#) on page 60
- [Compensated PVB with LS A/B](#) on page 63
- [Compensated high flow PVB](#) on page 67
- [Compensated high flow PVB with LS A/B](#) on page 70
- [Compensated PVBZ with POC](#) on page 74
- [Compensated high flow PVBZ with POC](#) on page 76
- [Compensated high flow PVBZ with POC and manifold interface](#) on page 78

Technical Information
PVG 32 Proportional Valve Group
PVB Basic Modules
Uncompensated PVB

The uncompensated PVB is intended for controlling a work function where the function behavior in terms of flow and pressures allows dependency on the load pressure of other functions used simultaneously.

The Uncompensated PVB features:

- Integrated LS shuttle network
- Optional shock/anti-cavitation valve facility (PVLP)
- Optional LS_{A/B} shuttle valve facility for float spool use
- Optional T0 facility

Schematic

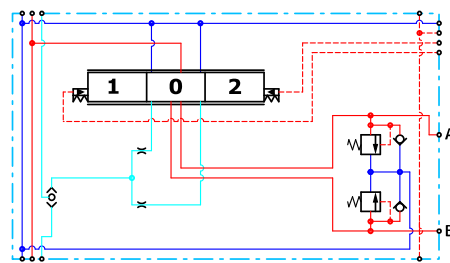

Uncompensated PVB with T0

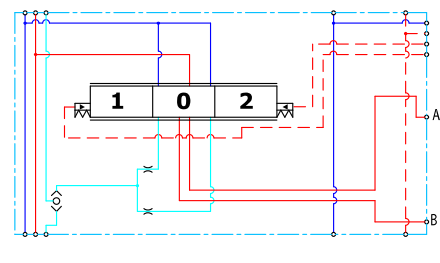

Technical specification for A/B-port

Max. continuous pressure	Max. intermittent pressure	Max. rated flow
350 bar [5076 psi]*	420 bar [6090 psi]**	125 l/min [33 US gal/min]

* With PVS1 end plate. With PVS end plate max. 300 bar [4351 psi]

** Intermittent pressure at max. 250,000 cycles of full PVG life time cycles, with PVS1 end plate. The maximum intermittent pressure at max. 250,000 cycles stresses the need to confirm application duty cycle before proceeding with specification. For further information contact Danfoss Product Application Engineering.

Technical specification

Parameter	Minimum	Recommended range	Maximum
Fluid temperature	-30°C [-22°F]	30 to 60°C [86 to 140°F]	90° [194°F]
Fluid viscosity	4 mm ² /s [39 SUS]	12 to 75 mm ² /s [65 to 347 SUS]	460 mm ² /s [2128 SUS]
Fluid cleanliness (mechanical activation)	23/19/16 (according to ISO 4406)		
Fluid cleanliness (PVE activation)	18/16/13 (according to ISO 4406)		
Operating temperature	Ambient: -30 to 60°C [-22 to 140°F]		

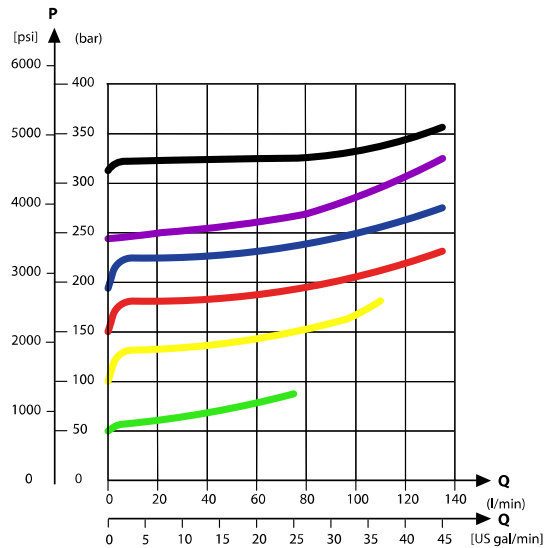
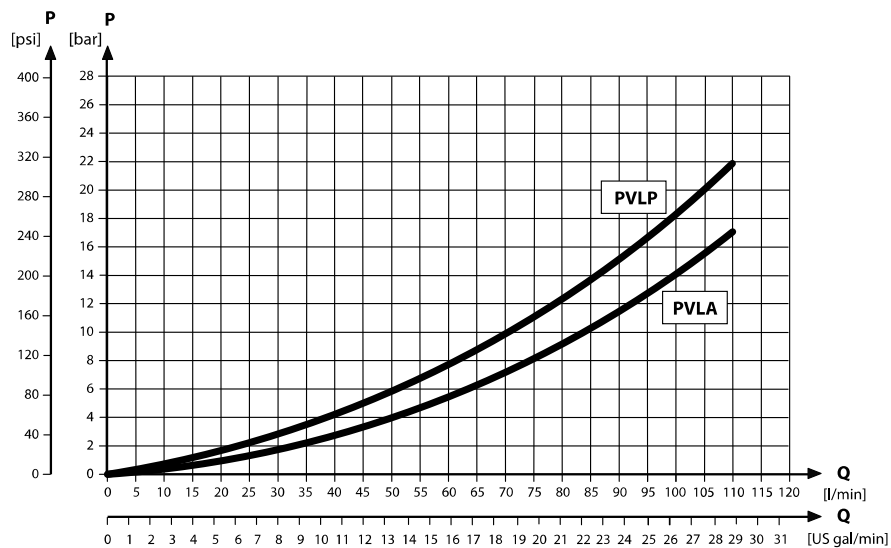
Technical Information
PVG 32 Proportional Valve Group
PVB Basic Modules
Performance graphs (Theoretical)
PVLP shock valve characteristics

PVLP/PVLA suction valve characteristics

Part numbers for uncompensated PVB

Part number	A/B-port	PVLP/PVLA	LS A/B shuttle	T0 facility
157B6000	G1/2"	—	—	—
157B6010		—	—	Yes
157B6030		Yes	—	—
11071832		Yes	Yes	—

Technical Information
PVG 32 Proportional Valve Group

PVB Basic Modules

Part numbers for uncompensated PVB (continued)

Part number	A/B-port	PVLP/PVLA	LS A/B shuttle	T0 facility
157B6400	7/8-14 UNF	—	—	—
157B6410		—	—	Yes
157B6430		Yes	—	—

PVB Basic Modules
Uncompensated PVB with load drop check valve

The uncompensated PVB is intended for controlling a work function where the function behavior in terms of flow and pressures allows dependency on the load pressure of other functions used simultaneously. The integrated load drop check valve prevents flow back from work ports influencing other functions.

The Uncompensated PVB with load drop check valve features:

- Integrated LS shuttle network
- Load drop check valve
- Optional shock/anti-cavitation valve facility (PVLP)
- Optional LS_{A/B} shuttle valve facility for float spool use
- Optional T0 facility

Uncompensated PVB with load drop check valve

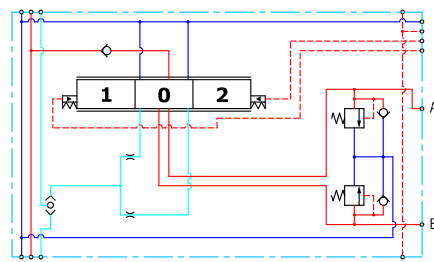

Uncompensated PVB with load drop check valve and T0

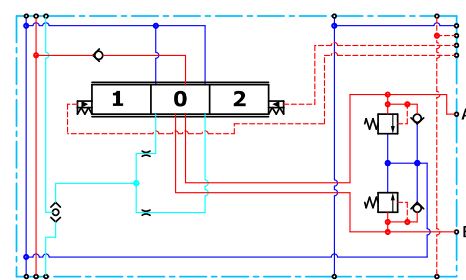

Technical specification for A/B-port

Max. continuous pressure	Max. intermittent pressure	Max. rated flow
350 bar [5076 psi]	420 bar [6090 psi]	125 l/min [33 US gal/min]

Technical specification

Parameter	Minimum	Recommended range	Maximum
Fluid temperature	-30°C [-22°F]	30 to 60°C [86 to 140°F]	90° [194°F]
Fluid viscosity	4 mm ² /s [39 SUS]	12 to 75 mm ² /s [65 to 347 SUS]	460 mm ² /s [2128 SUS]
Fluid cleanliness (mechanical activation)	23/19/16 (according to ISO 4406)		
Fluid cleanliness (PVE activation)	18/16/13 (according to ISO 4406)		
Operating temperature	Ambient: -30 to 60°C [-22 to 140°F]		

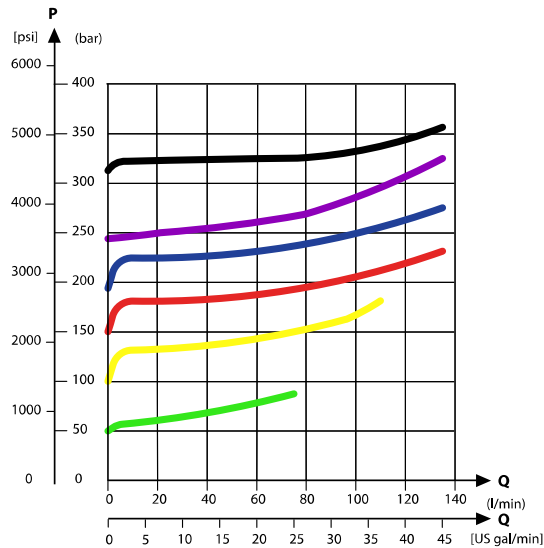
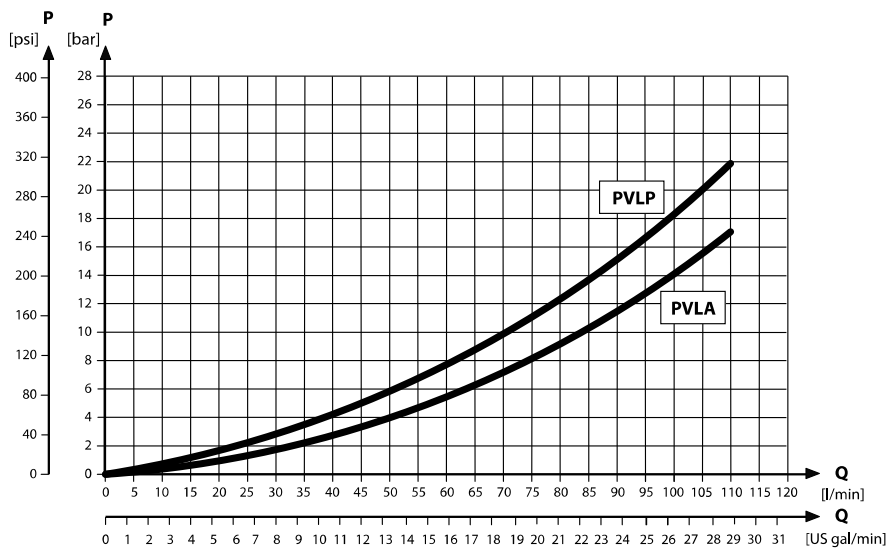
Technical Information
PVG 32 Proportional Valve Group
PVB Basic Modules
Performance graphs (Theoretical)
PVLP shock valve characteristics

PVLP/PVLA suction valve characteristics

Part numbers for Uncomp. PVB with load drop check valve

Part number	A/B-port	PVLP/PVLA	LS A/B shuttle	T0 facility
157B6100	G1/2"	—	—	—
157B6500	7/8-14 UNF	—	—	—
157B6110	G1/2"	—	—	Yes
157B6909	7/8-14 UNF	—	—	Yes

PVB Basic Modules
Part numbers for Uncomp. PVB with load drop check valve (continued)

Part number	A/B-port	PVLP/PVLA	LS A/B shuttle	T0 facility
157B6130	G1/2"	Yes	—	—
157B6530	7/8–14 UNF	Yes	—	—
157B6140	G1/2"	Yes	—	Yes
157B6904	7/8–14 UNF	Yes	—	Yes
157B6136	G1/2"	Yes	Yes	—
157B6536	7/8–14 UNF	Yes	Yes	—

Technical Information
PVG 32 Proportional Valve Group
PVB Basic Modules
Uncompensated PVBZ with POC

The uncompensated PVBZ is intended for controlling a work function where the function behavior in terms of flow and pressures allows dependency on the load pressure of other functions used simultaneously.

The Pilot Operated Check valve giving very low leakage will prevent cylinder creep.

The Uncompensated PVBZ with POC features:

- Integrated LS shuttle network
- Integrated POC
- T0 facility

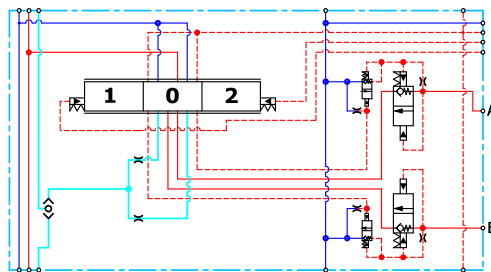
Schematic

Technical specification for A/B-port

Max. continuous pressure	Max. intermittent pressure	Max. rated flow
350 bar [5076 psi]	420 bar [6090 psi]	125 l/min [33 US gal/min]

Technical specification

Parameter	Minimum	Recommended range	Maximum
Fluid temperature	-30°C [-22°F]	30 to 60°C [86 to 140°F]	90° [194°F]
Fluid viscosity	4 mm ² /s [39 SUS]	12 to 75 mm ² /s [65 to 347 SUS]	460 mm ² /s [2128 SUS]
Fluid cleanliness (mechanical activation)	23/19/16 (according to ISO 4406)		
Fluid cleanliness (PVE activation)	18/16/13 (according to ISO 4406)		
Operating temperature	Ambient: -30 to 60°C [-22 to 140°F]		

Part numbers for uncompensated PVBZ with POC

Part number	A/B-port	POC
157B6051	G½"	B-port
157B6052		A/B-port
157B6451	7/8–14 UNF	B-port
157B6452		A/B-port

Technical Information
PVG 32 Proportional Valve Group
PVB Basic Modules
Compensated PVB

The compensated PVB is intended for controlling a work function where the function behavior in terms of flow and pressures requires independence on the load pressure of other functions used simultaneously.

The Compensated PVB features:

- Integrated LS shuttle network
- Integrated compensator with bleed-off
- Optional shock/anti-cavitation valve facility (PVLP)
- Optional T0 facility and external T0 port

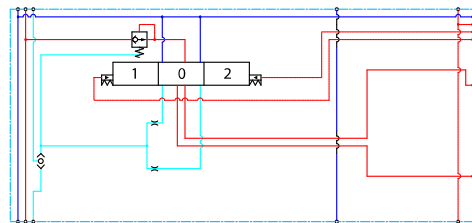
Compensated PVB schematic

Technical specification for A/B-port

Max. continuous pressure	Max. intermittent pressure	Max. rated flow *
350 bar [5067 psi]	420 bar [6090 psi]	125 l/min [33 US gal/min]

* With turbo function spool @ max rated flow of 130 l/min is possible

Technical specification

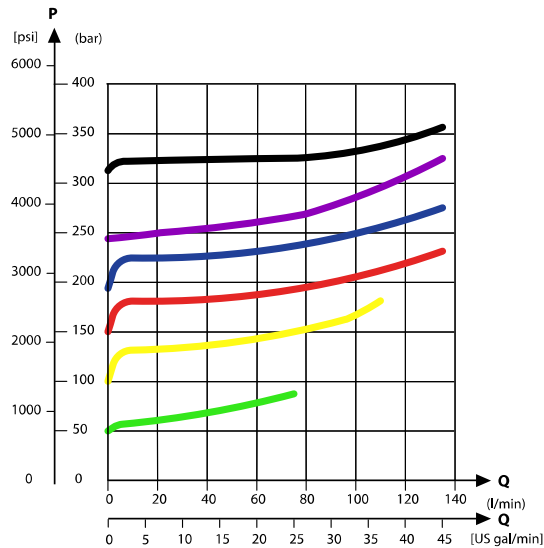
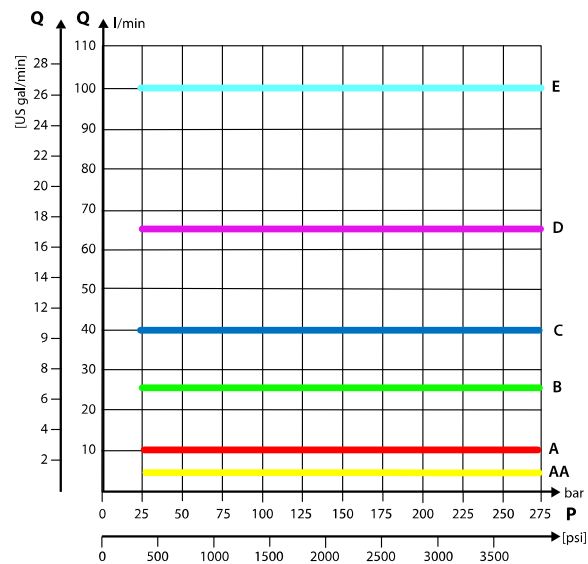
Parameter	Minimum	Recommended range	Maximum
Fluid temperature	-30°C [-22°F]	30 to 60°C [86 to 140°F]	90° [194°F]
Fluid viscosity	4 mm ² /s [39 SUS]	12 to 75 mm ² /s [65 to 347 SUS]	460 mm ² /s [2128 SUS]
Fluid cleanliness (mechanical activation)	23/19/16 (according to ISO 4406)		
Fluid cleanliness (PVE activation)	18/16/13 (according to ISO 4406)		
Operating temperature	Ambient: -30 to 60°C [-22 to 140°F]		

Technical Information
PVG 32 Proportional Valve Group
PVB Basic Modules
Performance graphs (Theoretical)
PVLP shock valve characteristics

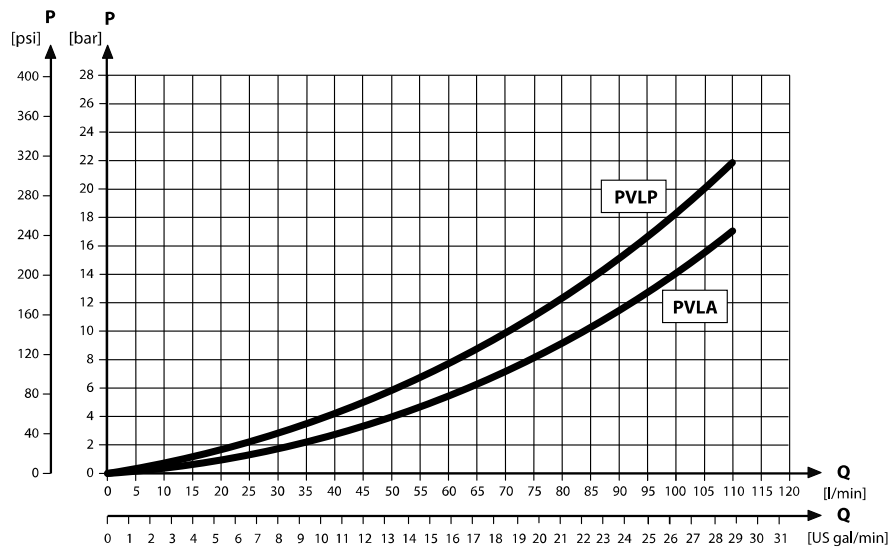
Load Independent Fluid Flow – Pressure Compensated PVB

Technical Information
PVG 32 Proportional Valve Group
PVB Basic Modules
PVLP/PVLA suction valve characteristics

Part numbers for compensated PVB

Part number	A/B-port	PVLP/PVLA	T0
157B6200	G1/2"	-	-
157B6210		-	Yes
157B6230		Yes	-
157B6240		Yes	Yes
157B6600	7/8-14 UNF	-	-
157B6922		-	Yes
157B6630		Yes	-
157B6906		Yes	Yes
157B6850	M22x1.5	Yes	Yes
157B6849	None*	-	-

* Machined top, prepared for customized interface.

Technical Information
PVG 32 Proportional Valve Group
PVB Basic Modules
Dampened Compensated PVB

The compensated PVB is intended for controlling a work function where the function behavior in terms of flow and pressures requires independence on the load pressure of other functions used simultaneously. The dampening of the compensator reaction will slow down the system thereby removing instability.

The dampened compensated PVB features:

- Integrated LS shuttle network
- Integrated compensator with bleed-off
- Optional shock/anti-cavitation valve facility (PVLP)

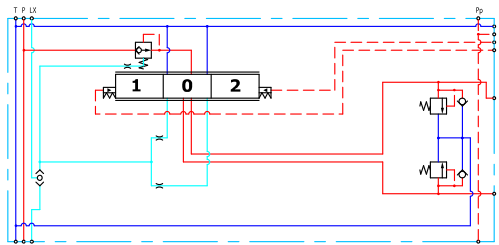
Compensated PVB schematic

Technical specification for A/B-port

Max. continuous pressure	Max. intermittent pressure	Max. rated flow*
350 bar [5076 psi]	420 bar [6090 psi]	125 l/min [33 US gal/min]

* With turbo function spool @ max rated flow of 130 l/min is possible

Technical specification

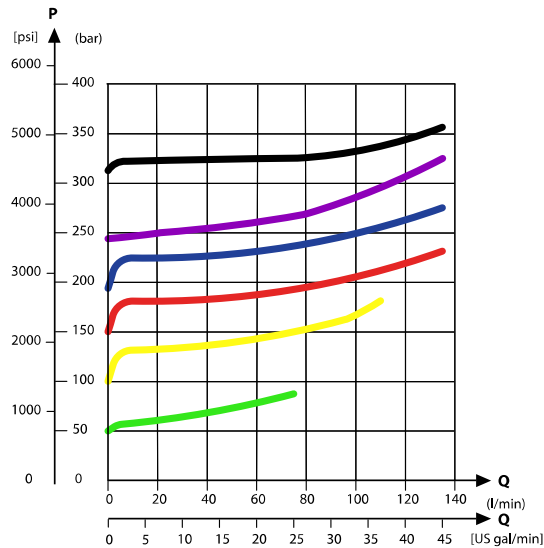
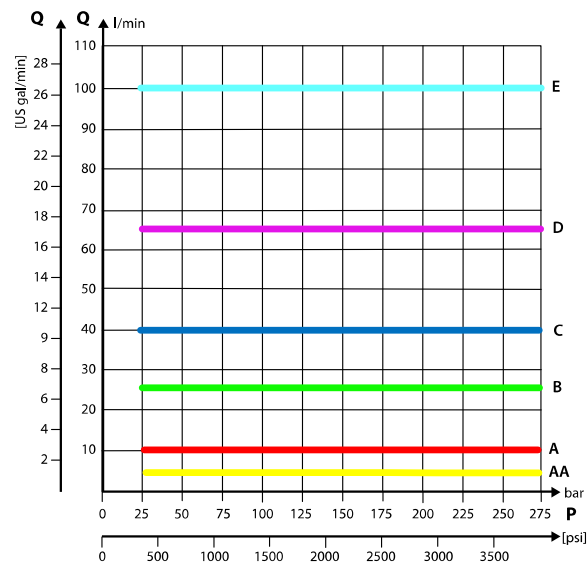
Parameter	Minimum	Recommended range	Maximum
Fluid temperature	-30°C [-22°F]	30 to 60°C [86 to 140°F]	90° [194°F]
Fluid viscosity	4 mm ² /s [39 SUS]	12 to 75 mm ² /s [65 to 347 SUS]	460 mm ² /s [2128 SUS]
Fluid cleanliness (mechanical activation)	23/19/16 (according to ISO 4406)		
Fluid cleanliness (PVE activation)	18/16/13 (according to ISO 4406)		
Operating temperature	Ambient: -30 to 60°C [-22 to 140°F]		

PVB Basic Modules
Performance graphs (Theoretical)
PVLP shock valve characteristics

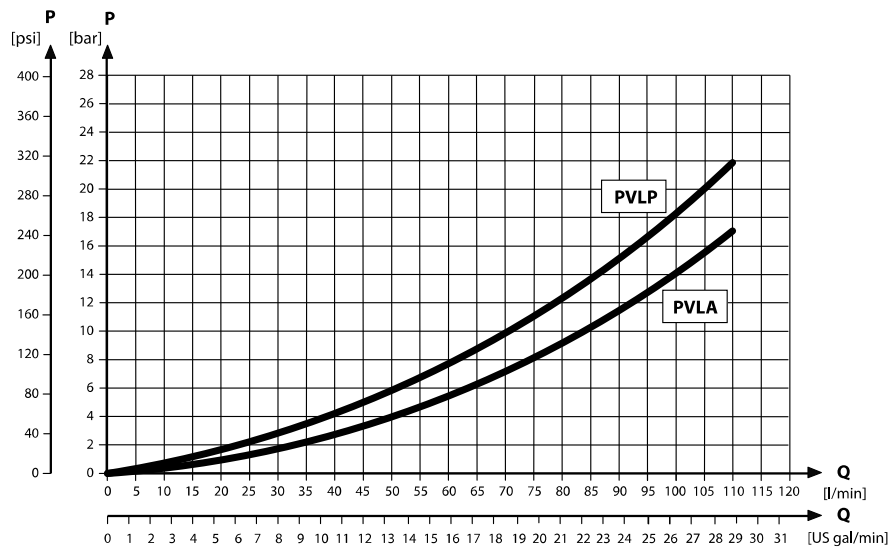
Load Independent Fluid Flow – Pressure Compensated PVB

Technical Information
PVG 32 Proportional Valve Group
PVB Basic Modules
PVLP/PVLA suction valve characteristics

Part numbers for damp. compensated PVB

Part number	A/B-port	PVLP/PVLA
157B6206	G1/2"	-
157B6236		Yes
11036629	7/8-14 UNF	-
11036630		Yes

PVB Basic Modules
Dampened compensated PVB with LS A/B

The compensated PVB is intended for controlling a work function where the function behavior in terms of flow and pressures requires independence on the load pressure of other functions used simultaneously. The dampening of the compensator reaction will slow down the system thereby removing instability. The integrated $LS_{A/B}$ relief valve is used to limit the maximum work port build-up on the A/B-ports individually.

The dampened compensated PVB with LS A/B features:

- Integrated LS shuttle network
- Integrated compensator
- Integrated adjustable $LS_{A/B}$ pressure relief valves
- External $LS_{A/B}$ port connection
- Optional shock/anti-cavitation valve facility (PVLP)

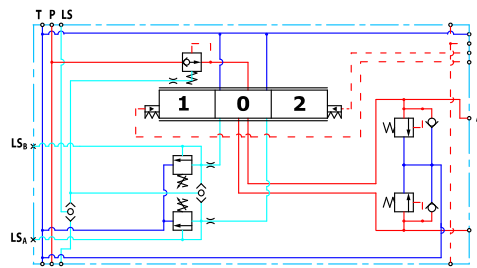
Dampened compensated PVB with LS A/B schematic

Technical specification for A/B-port

Max. continuous pressure	Max. intermittent pressure	Max. rated flow*
350 bar [5076 psi]	420 bar [6090 psi]	125 l/min [33 US gal/min]

*With turbo function spool @ max rated flow of 130 l/min is possible

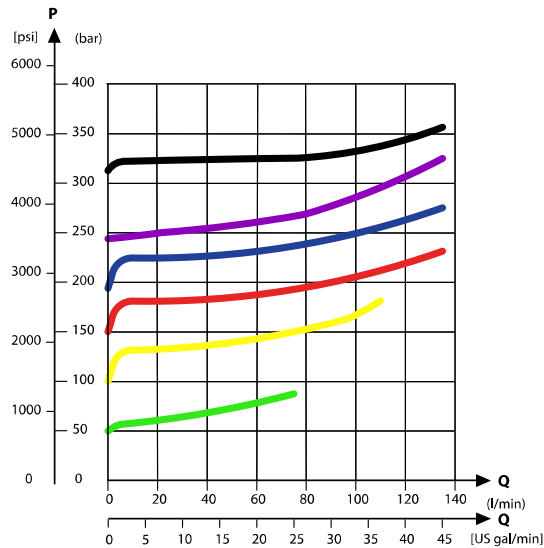
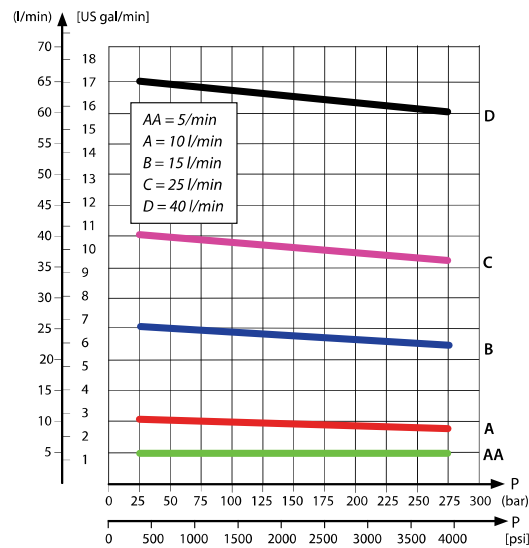
Parameter	Minimum	Recommended range	Maximum
Fluid temperature	-30°C [-22°F]	30 to 60°C [86 to 140°F]	90°C [194°F]
Fluid viscosity	4 mm ² /s [39 SUS]	12 to 75 mm ² /s [65 to 347 SUS]	460 mm ² /s [2128 SUS]
Fluid cleanliness (mechanical activation)	23/19/16 (according to ISO 4406)		
Fluid cleanliness (PVE activation)	18/16/13 (according to ISO 4406)		
Operating temperature	Ambient: -30 to 60°C [-22 to 140°F]		

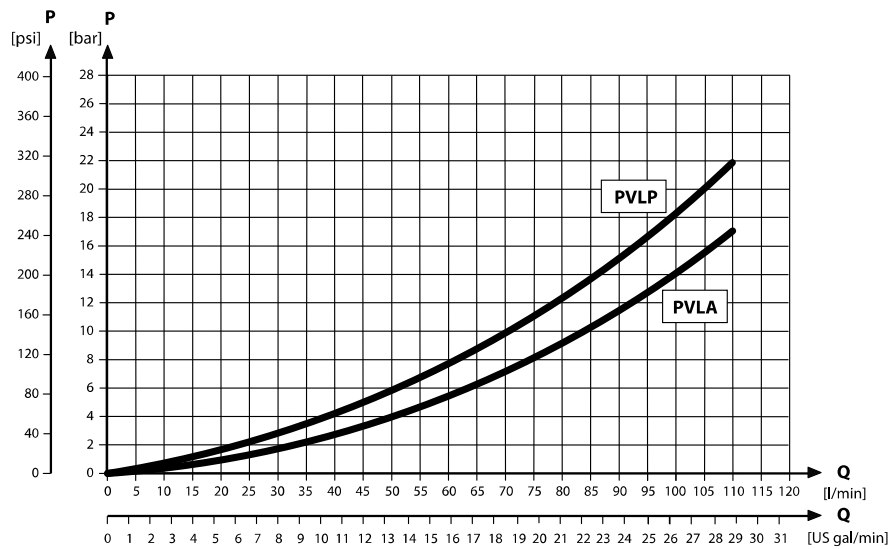
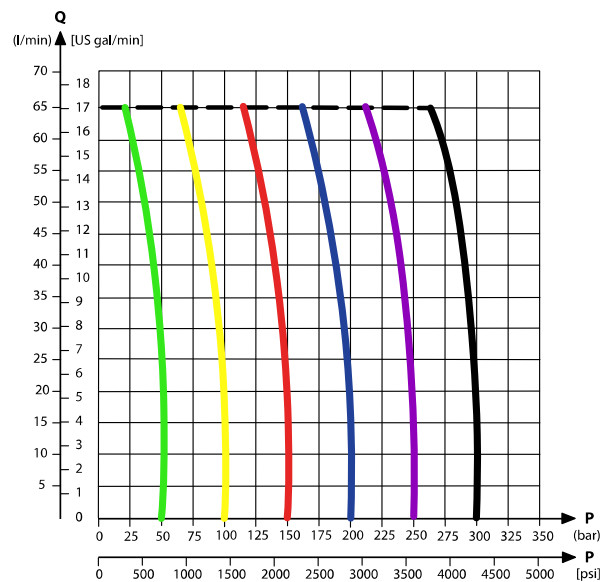
Technical Information
PVG 32 Proportional Valve Group
PVB Basic Modules
Performance graphs (Theoretical)
PVLP shock valve characteristics

Load Independent Fluid Flow – Pressure Compensated PVB

Technical Information
PVG 32 Proportional Valve Group
PVB Basic Modules
PVLP/PVLA suction valve characteristics

PVB pressure compensated for LS A/B characteristics

Part number	A/B-port	LS-port	PVLP/PVLA
157B6208	G1/2	G1/4	-
157B6238			Yes
11036631	7/8-14	1/2-20	Yes

Technical Information
PVG 32 Proportional Valve Group
PVB Basic Modules
Compensated PVB with LS A/B

The compensated PVB is intended for controlling a work function where the function behavior in terms of flow and pressures requires independency on the load pressure of other functions used simultaneously. The integrated LS_{A/B} relief valve is used to limit the maximum work port build-up on the A/B-ports individually.

The compensated PVB with LS_{A/B} features:

- Integrated LS shuttle network
- Integrated compensator with bleed-off
- Integrated adjustable LS_{A/B} pressure relief valves
- External LS_{A/B} port connection
- Integrated LS_{A/B} shuttle valve for float spool usage
- Optional shock/anti-cavitation valve facility (PVLP)
- Optional T0 facility

Compensated PVB with LS

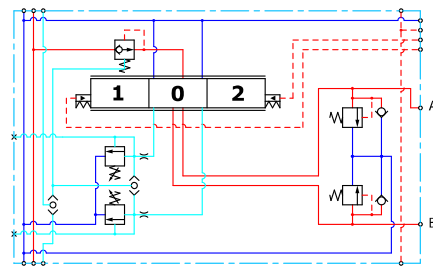

Compensated PVB with LS and T0

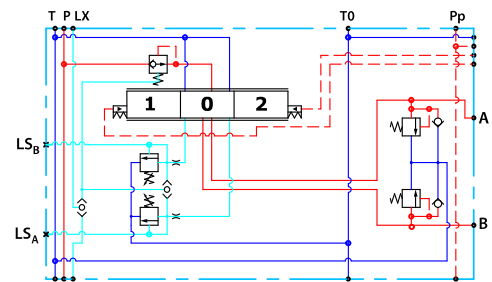

Technical specification for A/B-port

Max. continuous pressure	Max. intermittent pressure	Max. rated flow*
350 bar [5076 psi]	420 bar [6090 psi]	125 l/min [33 US gal/min]

* With turbo function spool @ max rated flow of 130 l/min is possible

Technical specification

Parameter	Minimum	Recommended range	Maximum
Fluid temperature	-30°C [-22°F]	30 to 60°C [86 to 140°F]	90° [194°F]
Fluid viscosity	4 mm ² /s [39 SUS]	12 to 75 mm ² /s [65 to 347 SUS]	460 mm ² /s [2128 SUS]
Fluid cleanliness (mechanical activation)	23/19/16 (according to ISO 4406)		
Fluid cleanliness (PVE activation)	18/16/13 (according to ISO 4406)		
Operating temperature	Ambient: -30 to 60°C [-22 to 140°F]		

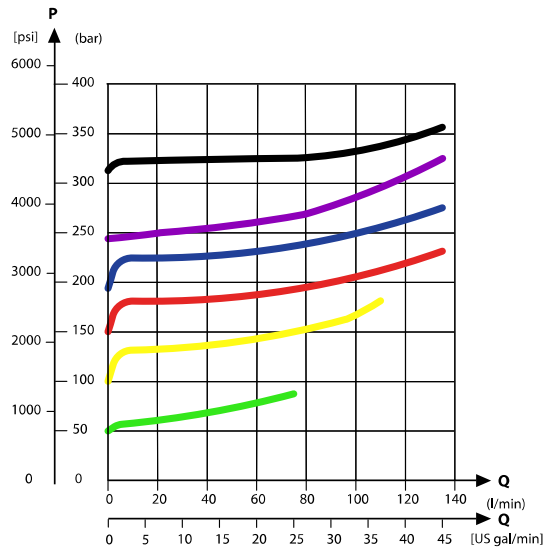
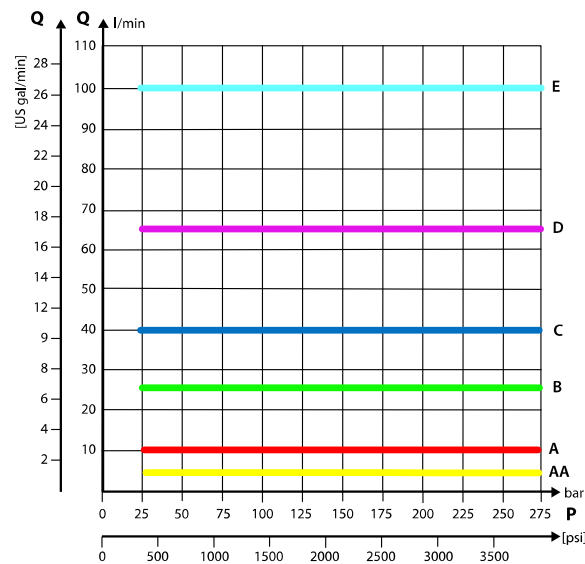
PVB Basic Modules
Performance graphs (Theoretical)
PVLP shock valve characteristics

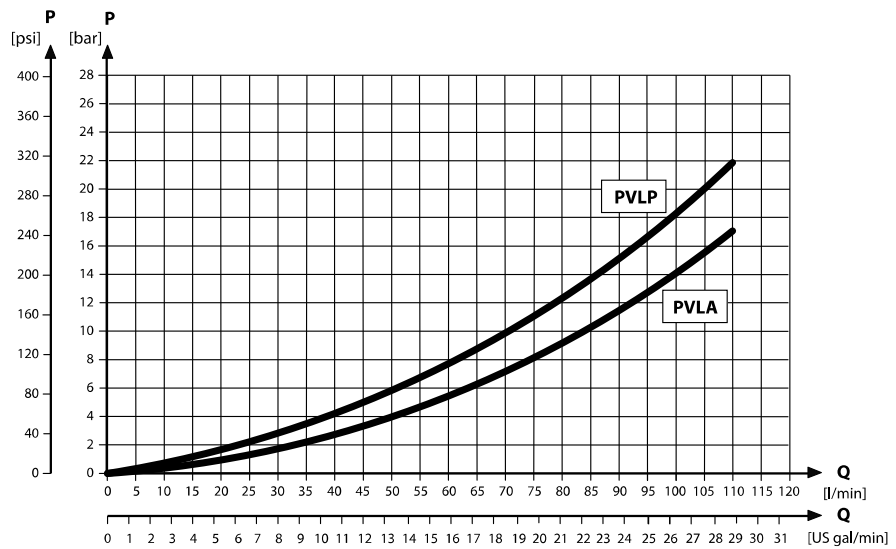
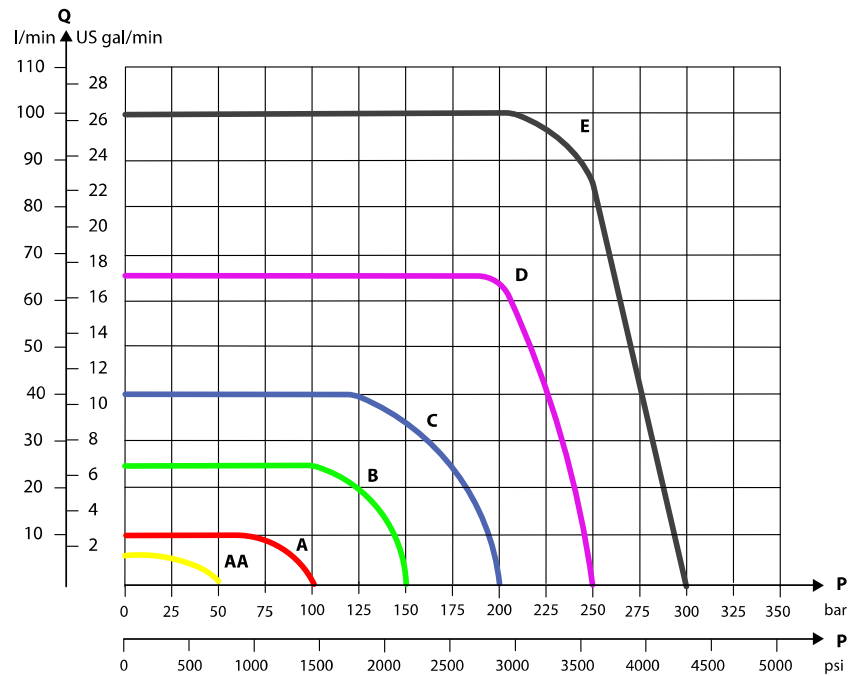
Load Independent Fluid Flow – Pressure Compensated PVB

Technical Information
PVG 32 Proportional Valve Group
PVB Basic Modules
PVLP/PVLA suction valve characteristics

PVB pressure compensated for LS A/B characteristics

Technical Information
PVG 32 Proportional Valve Group

PVB Basic Modules

Part numbers for compensated PVB with LS A/B (all with shuttle)

Part number	A/B-port	LS-port	PVLP/PVLA	T0
157B6203	G1/2"	G1/4"	-	-
157B6213			-	Yes
157B6233			Yes	-
157B6243			Yes	Yes
157B6603	7/8-14 UNF	1/2-20 UNF	-	-
157B6613			-	Yes
157B6633			Yes	-
157B6643			Yes	Yes

PVB Basic Modules
Compensated high flow PVB

The compensated PVB is intended for controlling a work function where the function behavior in terms of flow and pressures requires independence on the load pressure of other functions used simultaneously.

The bleed-off will prevent pressure build-up on the work ports in neutral.

Features

- Integrated LS shuttle network
- Integrated high flow compensator with bleed-off
- Optional shock/anti-cavitation valve facility (PVLP)
- Optional T0 facility

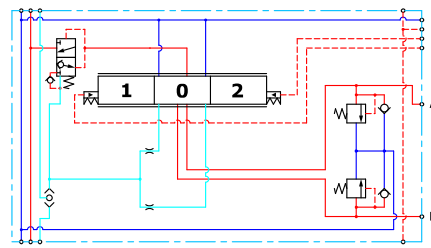
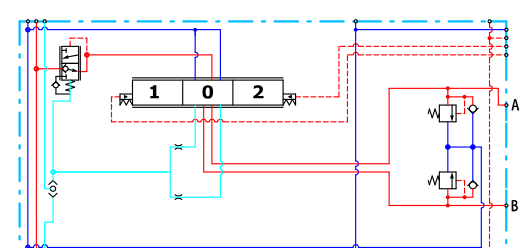
Compensated high flow PVB

Compensated high flow PVB with T0

Technical specification for A/B-port

Max. continuous pressure	Max. intermittent pressure	Max. rated flow
350 bar [5076 psi]	420 bar [6090 psi]	130 l/min [34 US gal/min]

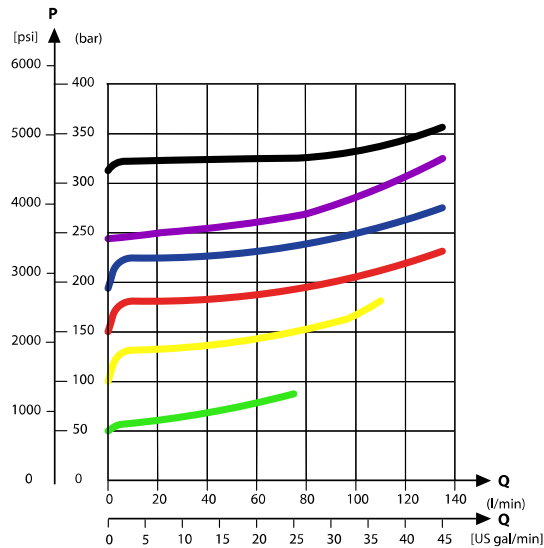
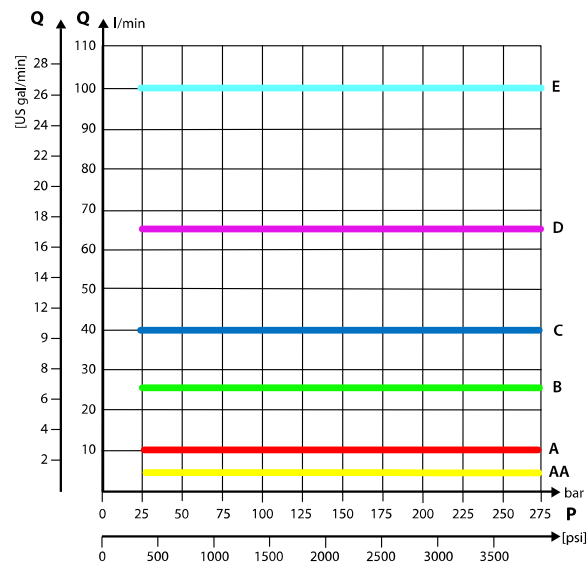
Technical specification

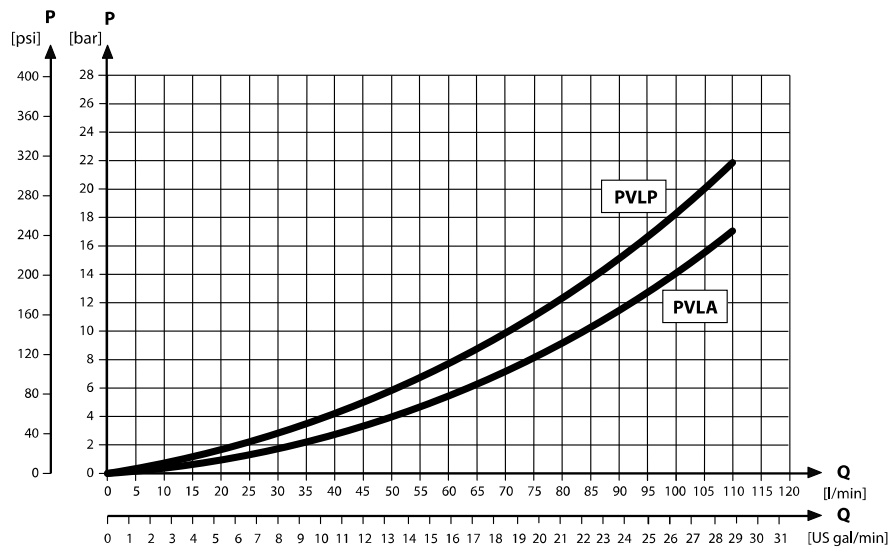
Parameter	Minimum	Recommended range	Maximum
Fluid temperature	-30°C [-22°F]	30 to 60°C [86 to 140°F]	90° [194°F]
Fluid viscosity	4 mm ² /s [39 SUS]	12 to 75 mm ² /s [65 to 347 SUS]	460 mm ² /s [2128 SUS]
Fluid cleanliness (mechanical activation)	23/19/16 (according to ISO 4406)		
Fluid cleanliness (PVE activation)	18/16/13 (according to ISO 4406)		
Operating temperature	Ambient: -30 to 60°C [-22 to 140°F]		

PVB Basic Modules
Performance graphs (Theoretical)
PVLP shock valve characteristics

Load Independent Fluid Flow – Pressure Compensated PVB

Technical Information
PVG 32 Proportional Valve Group
PVB Basic Modules
PVLP/PVLA suction valve characteristics

Part numbers for compensated high flow PVB

Part number	A/B-port	PVLP/PVLA	T0 facility
11126962	7/8-14 UNF	—	Yes
157B6938		Yes	—
157B6852	G $\frac{1}{2}$ "	Yes	—
157B6853		—	—

PVB Basic Modules
Compensated high flow PVB with LS A/B

The compensated PVB is intended for controlling a work function where the function behavior in terms of flow and pressures requires independence on the load pressure of other functions used simultaneously. The integrated LS_{A/B} relief valve is used to limit the maximum work port build-up on the A/B-ports individually.

The bleed-off will prevent pressure build-up on the work ports in neutral.

Features

- Integrated LS shuttle network
- Integrated high flow compensator with bleed-off
- Integrated adjustable LS_{A/B} pressure relief valves
- Integrated LS_{A/B} shuttle valve for float spool usage
- External LS_{A/B} port connection
- Optional shock/anti-cavitation valve facility (PVLP)
- Optional T0 facility

Compensated high flow PVB with LS A/B schematic

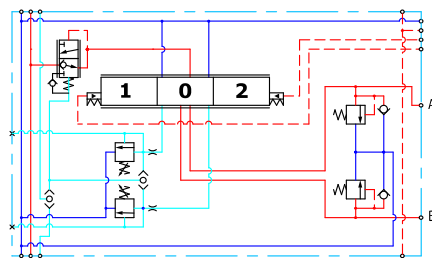

Compensated high flow PVB with LS A/B and T0

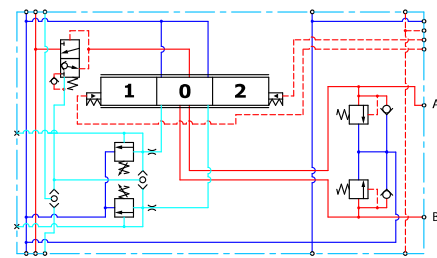

Technical specification for A/B-port

Max. continuous pressure	Max. intermittent pressure	Max. rated flow
350 bar [5076 psi]	420 bar [6090 psi]	130 l/min [34 US gal/min]

Technical specification

Parameter	Minimum	Recommended range	Maximum
Fluid temperature	-30°C [-22°F]	30 to 60°C [86 to 140°F]	90° [194°F]
Fluid viscosity	4 mm ² /s [39 SUS]	12 to 75 mm ² /s [65 to 347 SUS]	460 mm ² /s [2128 SUS]
Fluid cleanliness (mechanical activation)	23/19/16 (according to ISO 4406)		
Fluid cleanliness (PVE activation)	18/16/13 (according to ISO 4406)		
Operating temperature	Ambient: -30 to 60°C [-22 to 140°F]		

Technical Information
PVG 32 Proportional Valve Group

PVB Basic Modules

Performance graphs (Theoretical)

PVLP shock valve characteristics

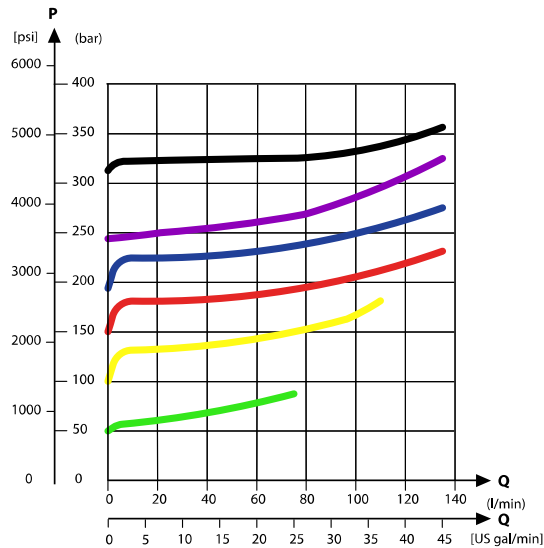

Load Independent Fluid Flow – Pressure Compensated PVB

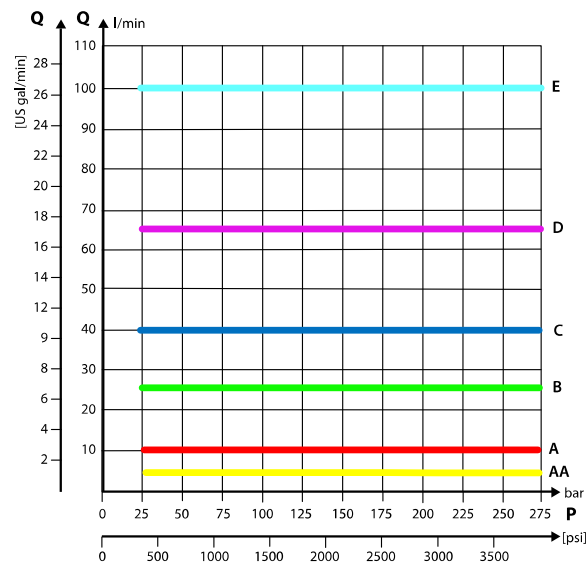

Technical Information
PVG 32 Proportional Valve Group

PVB Basic Modules

PVLP/PVLA suction valve characteristics

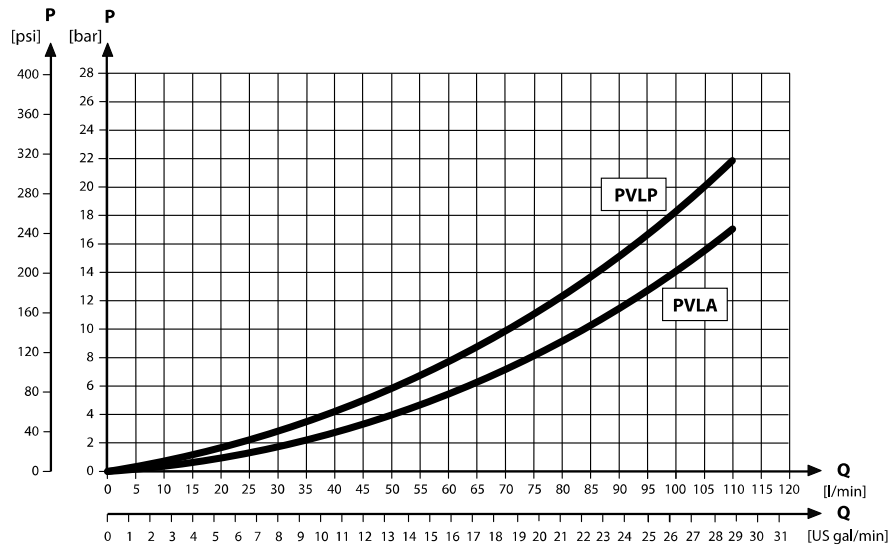

PVB pressure compensated for LS A/B characteristics

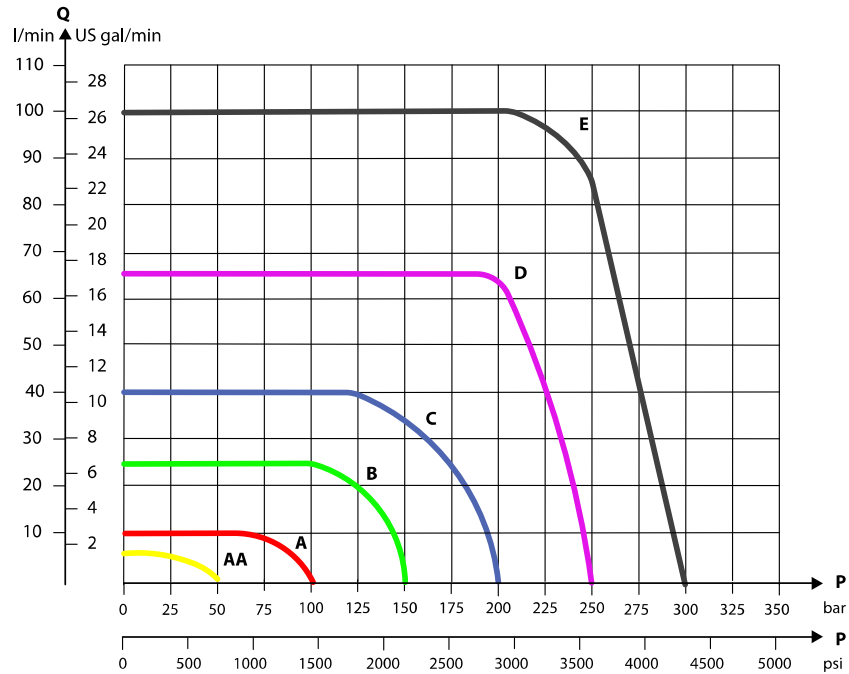

Technical Information
PVG 32 Proportional Valve Group

PVB Basic Modules

Part numbers for comp. high flow PVB with LS

Part number	A/B-port	LS _{A/B} port	PVLP/PVLA	LS _{A/B} shuttle	T0 facility
157B6855	G $\frac{1}{2}$ "	G $\frac{1}{4}$ "	—	Yes	—
11059838			—		Yes
157B6854			Yes		—
11126963	7/8-14 UNF	$\frac{1}{2}$ -20 UNF	—		Yes
11126964			Yes		Yes

PVB Basic Modules
Compensated PVBZ with POC

The compensated PVB is intended for controlling a work function where the function behavior in terms of flow and pressures requires independence on the load pressure of other functions used simultaneously.

The bleed-off will prevent pressure build-up on the work ports in neutral.

The Pilot Operated Check valve giving very low leakage will prevent cylinder creep.

Features

- Integrated LS shuttle network
- Integrated compensator with bleed-off
- Integrated POC
- T0 facility
- Optional LS_{A/B} shuttle valve facility for float spool use
- Optional thermo-relief valve

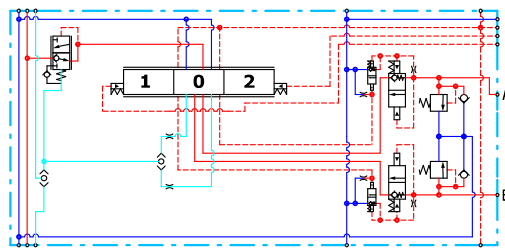
Schematic

Technical specification for A/B-port

Max. continuous pressure	Max. intermittent pressure	Max. rated flow
250 bar [3625 psi]	420 bar [6090 psi]	100 l/min [26 US gal/min]

Technical specification

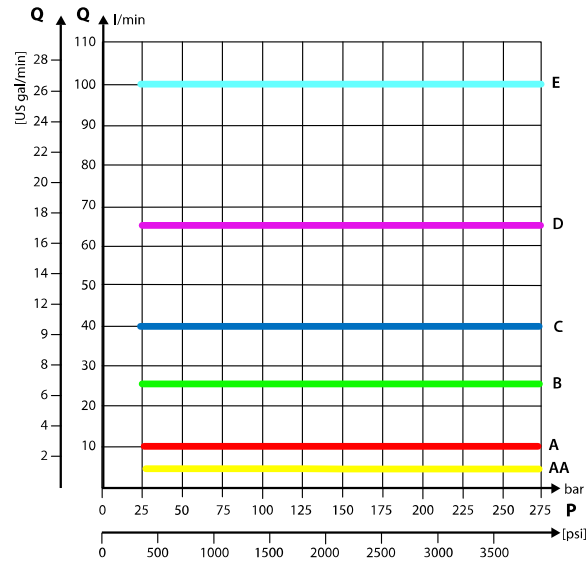
Parameter	Minimum	Recommended range	Maximum
Fluid temperature	-30°C [-22°F]	30 to 60°C [86 to 140°F]	90° [194°F]
Fluid viscosity	4 mm ² /s [39 SUS]	12 to 75 mm ² /s [65 to 347 SUS]	460 mm ² /s [2128 SUS]
Fluid cleanliness (mechanical activation)	23/19/16 (according to ISO 4406)		
Fluid cleanliness (PVE activation)	18/16/13 (according to ISO 4406)		
Operating temperature	Ambient: -30 to 60°C [-22 to 140°F]		

PVB Basic Modules
Performance graphs (Theoretical)
Load Independent Fluid Flow – Pressure Compensated PVB

Part numbers for compensated PVBZ with POC

Part number	A/B-port	POC	LS _{A/B} shuttle	Thermo relief
157B6251	G1/2"	B-port	—	—
157B6252		A/B-port	—	—
157B6261		B-port	—	Yes
157B6262		A/B-port	—	Yes
157B6266		A/B-port	Yes	Yes
157B6652	7/8–14 UNF	A/B-port	—	—
157B6661		A/B-port	—	Yes
157B6662		A/B-port	—	Yes
157B6666	A/B-port	Yes	Yes	Yes
157B6954	M22x1.5 mm	A/B-port	Yes	Yes
157B6958	None – machined top*	A/B-port	Yes	Yes
11157082	None – machined top*	—	—	—

* Prepared for mounting of a PVBD diverter. For more details, see [PVBD Diverter Module](#) on page 91.

PVB Basic Modules
Compensated high flow PVBZ with POC

The compensated high flow PVBZ with POC is intended for controlling a work function where the function behavior in terms of flow and pressures requires independence on the load pressure of other functions used simultaneously.

The bleed-off will prevent pressure build-up on the work ports in neutral.

The Pilot Operated Check valve giving very low leakage will prevent cylinder creep.

Features

- Integrated LS shuttle network
- Integrated high flow compensator with bleed-off
- Integrated POC
- T0 facility
- Optional LS_{A/B} shuttle valve facility for float spool use
- Optional shock/anti-cavitation valve facility (PVLP)

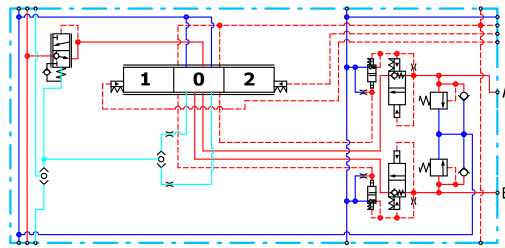
Schematic

Technical specification for A/B-port

Max. continuous pressure	Max. intermittent pressure	Max. rated flow
350 bar [5076 psi]	420 bar [6090 psi]	125 l/min [33 US gal/min]

Technical specification

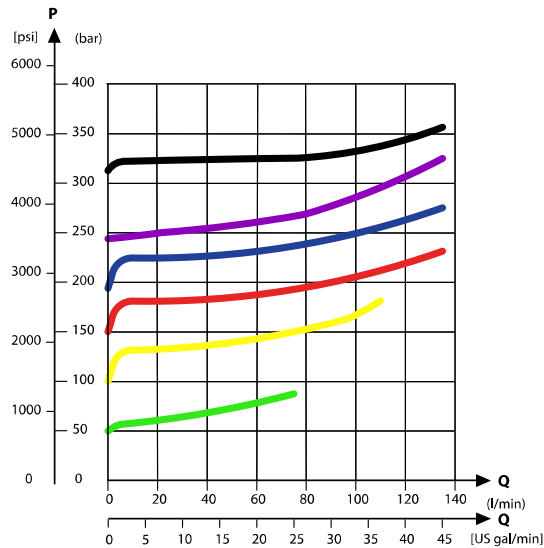
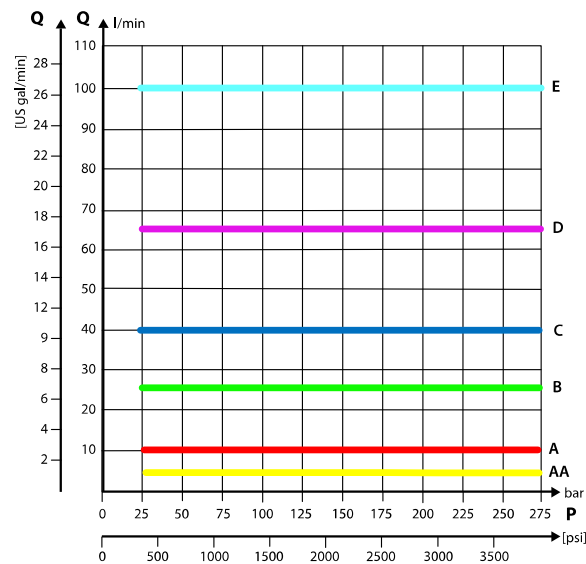
Parameter	Minimum	Recommended range	Maximum
Fluid temperature	-30°C [-22°F]	30 to 60°C [86 to 140°F]	90° [194°F]
Fluid viscosity	4 mm ² /s [39 SUS]	12 to 75 mm ² /s [65 to 347 SUS]	460 mm ² /s [2128 SUS]
Fluid cleanliness (mechanical activation)	23/19/16 (according to ISO 4406)		
Fluid cleanliness (PVE activation)	18/16/13 (according to ISO 4406)		
Operating temperature	Ambient: -30 to 60°C [-22 to 140°F]		

Technical Information
PVG 32 Proportional Valve Group
PVB Basic Modules
Performance graphs (Theoretical)
PVLP shock valve characteristics

Load Independent Fluid Flow – Pressure Compensated PVB

PVB Basic Modules
Compensated high flow PVBZ with POC and manifold interface

The compensated PVB is intended for controlling a work function where the function behavior in terms of flow and pressures requires independence on the load pressure of other functions used simultaneously.

The bleed-off will prevent pressure build-up on the work ports in neutral.

Features

- Integrated LS shuttle network
- Integrated high flow compensator with bleed-off
- Integrated POC
- T0 facility
- Optional thermo relief valve

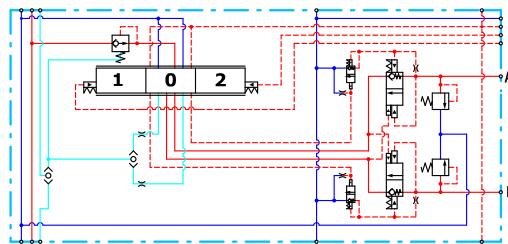
Schematic

Technical specification for A/B port

Max. continuous pressure	Max. intermittent pressure	Max. rated flow
250 bar [3625 psi]	420 bar [6090 psi]	125 l/min [33 US gal/min]

Technical specification

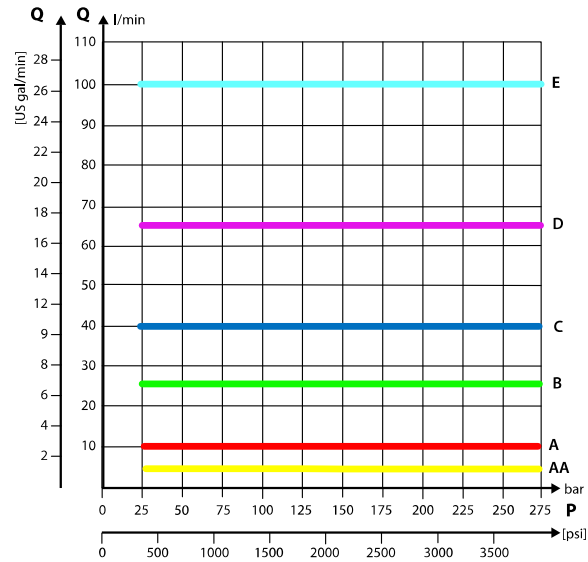
Parameter	Minimum	Recommended range	Maximum
Fluid temperature	-30°C [-22°F]	30 to 60°C [86 to 140°F]	90° [194°F]
Fluid viscosity	4 mm ² /s [39 SUS]	12 to 75 mm ² /s [65 to 347 SUS]	460 mm ² /s [2128 SUS]
Fluid cleanliness (mechanical activation)	23/19/16 (according to ISO 4406)		
Fluid cleanliness (PVE activation)	18/16/13 (according to ISO 4406)		
Operating temperature	Ambient: -30 to 60°C [-22 to 140°F]		

PVB Basic Modules
Performance graphs (Theoretical)
Load Independent Fluid Flow – Pressure Compensated PVB

Part numbers for PVBZ - POC, manifold interface

Part number	POC
157B6958	A/B-port
11005475	A/B-port
11032961	A/B-port
157B6969	-

Technical Information
PVG 32 Proportional Valve Group
PVB Basic Modules
Constant pressure PVB
Constant Pressure PVB

The constant pressure module is the first of its kind providing an integrated sectional valve solution with the ability to apply constant work port pressure. Special patented compensator feeds or relieves work port flow to tank depending on work port load situation.

The Constant Pressure PVB features:

- Integrated Load sense relief to set maximum port pressure (Common LSAB)
- Shock/anti-cavitation valve facility (PVL/PVLA)
- Optional T0 facility

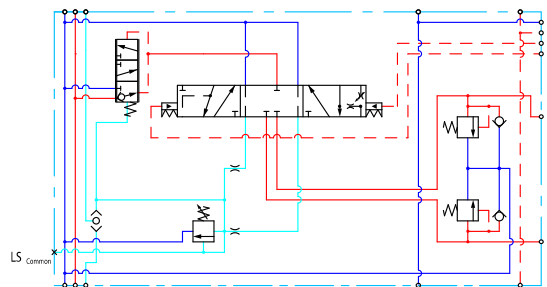
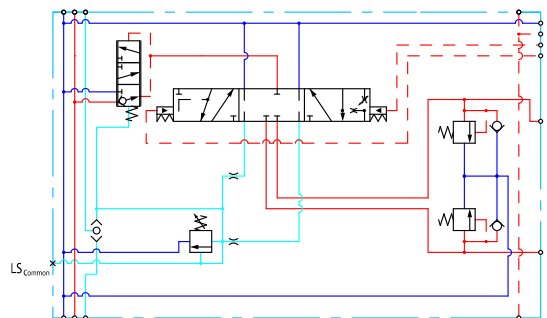
Constant Pressure PVB with T0

Constant Pressure PVB without T0

Technical specification for A/B-port

Max. continuous pressure	Max. intermittent pressure	Max. rated flow
350 bar [5076]*	420 bar [6090]**	125 l/min [33 US gal/min]

With PVS1 end plate. With PVS end plate max. 300 [4351 psi]

**

Intermittent pressure at max. 250,000 cycles of full PVG life time cycles, with PVS1 end plate. The maximum intermittent pressure at max. 250,000 cycles stresses the need to confirm application duty cycle before proceeding with specification. For further information contact Danfoss Product Application Engineering.

Technical Information
PVG 32 Proportional Valve Group

PVB Basic Modules
Technical specification

Parameter	Minimum	Recommended range	Maximum
Fluid temperature	-30°C [-22°F]	30 to 60°C [86 to 140°F]	90° [194°F]
Fluid viscosity	4 mm ² /s [39 SUS]	12 to 75 mm ² /s [65 to 347 SUS]	460 mm ² /s [2128 SUS]
Fluid cleanliness	23/19/16 (according to ISO 4406)		
Operating temperature	Ambient: -30 to 60°C [-22 to 140°F]		

Part numbers for Constant Pressure PVB

Part number	A/B-port	LSa-port	T0
11166045	G1/2 BSP	G1/4 BSP	Yes
11186267	7/8-14 UNF	½-20 UNF	Yes
11216266	G1/2 BSP	G1/4 BSP	-
11216270	7/8-14 UNF	½-20 UNF	-

PVB Basic Modules Accessories

The generic PVB module accessory platform include the PVLP shock and anti-cavitation valve and PVLA suction valve.

- [PVLP Shock and Anti-Cavitation Valve](#) on page 83
- [PVLA Suction Valve](#) on page 85

Technical Information
PVG 32 Proportional Valve Group
PVB Basic Modules Accessories
PVLP Shock and Anti-Cavitation Valve

The PVLP shock and anti-cavitation valve will relieve a pressure peak to the internal tank galleries and will furthermore suck oil from the tank to the work port to prevent cavitation. Pressure settings range: 32–400 bar [460–5801 psi].

The pressure setting of the PVLP must always be 20 bar [290 psi] higher than $LS_{A/B}$ setting in the same module.

PVLP schematic

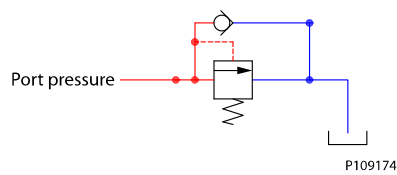

PVLP shock valve characteristics

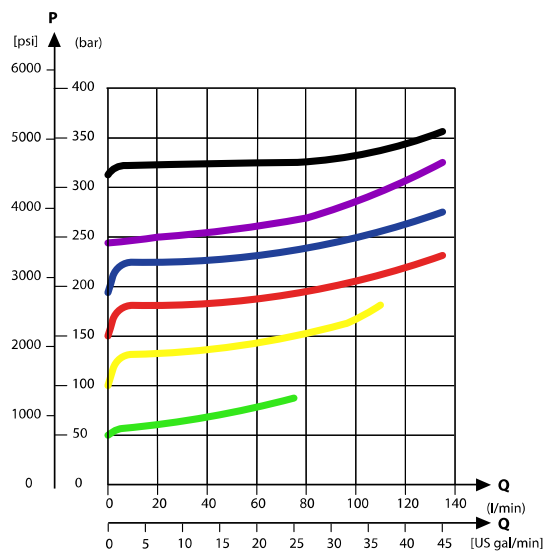

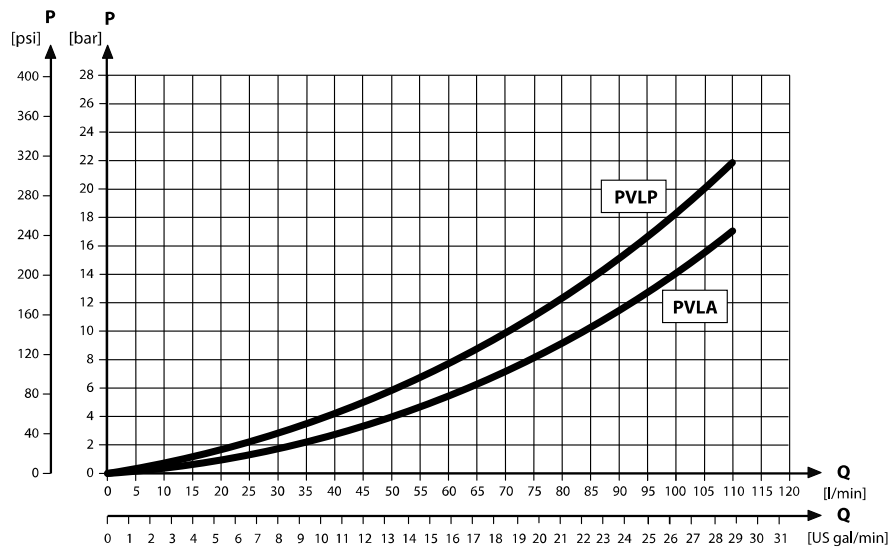
Technical Information
PVG 32 Proportional Valve Group
PVB Basic Modules Accessories
PVLP/PVLA suction valve characteristics

Technical specification

Parameter	Minimum	Recommended range	Maximum
Fluid temperature	-30°C [-22°F]	30 to 60°C [86 to 140°F]	90° [194°F]
Fluid viscosity	4 mm ² /s [39 SUS]	12 to 75 mm ² /s [65 to 347 SUS]	460 mm ² /s [2128 SUS]
Fluid cleanliness (mechanical activation)	23/19/16 (according to ISO 4406)		
Fluid cleanliness (PVE activation)	18/16/13 (according to ISO 4406)		
Operating temperature	Ambient: -30 to 60°C [-22 to 140°F]		

Part numbers for PVLP according to pressure settings

Part number	Pressure in bar [psi]	Part number	Pressure in bar [psi]
157B2032	32 [464]	157B2210	210 [3045]
157B2050	50 [725]	157B2230	230 [3335]
157B2063	63 [913]	157B2240	240 [3480]
157B2080	80 [1160]	157B2250	250 [3626]
157B2100	100 [1450]	157B2265	265 [3844]
157B2125	125 [1813]	157B2280	280 [4061]
157B2140	140 [2031]	157B2300	300 [4351]
157B2150	150 [2176]	157B2320	320 [4641]
157B2160	160 [2321]	157B2350	350 [5076]
157B2175	175 [2538]	157B2380	380 [5511]
157B2190	190 [2756]		—

Technical Information
PVG 32 Proportional Valve Group
PVB Basic Modules Accessories
PVLA Suction Valve

The PVLA valve is an accessory available for PVB basic modules.

The PVLA will suck fluid from the tank to the work port to prevent cavitation by the 0.5 bar spring. The plug will ensure that when using a single acting spool, all flow returning through the work port is led to tank.

PVLA schematic

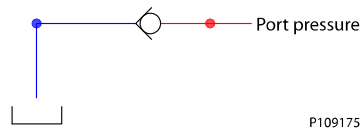

PVLP/PVLA suction valve characteristics

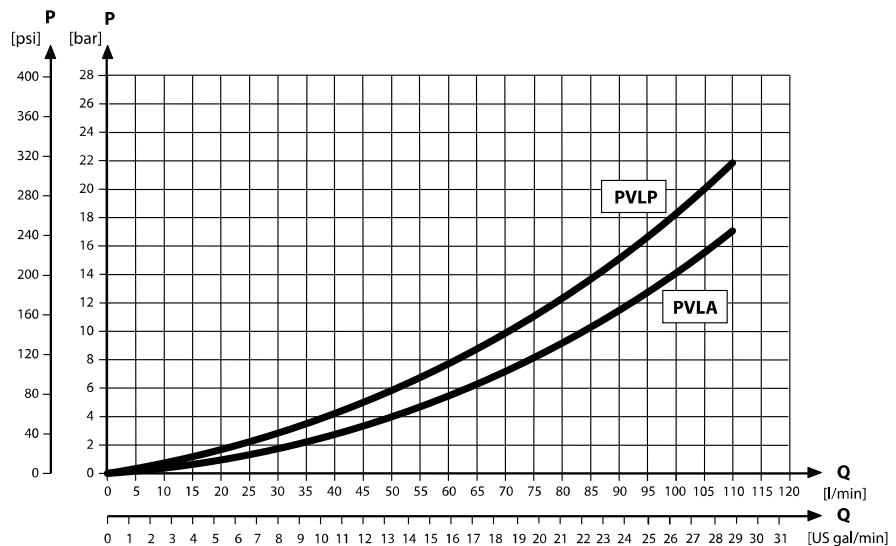

Technical specification

Parameter	Minimum	Recommended range	Maximum
Fluid temperature	-30°C [-22°F]	30 to 60°C [86 to 140°F]	90° [194°F]
Fluid viscosity	4 mm ² /s [39 SUS]	12 to 75 mm ² /s [65 to 347 SUS]	460 mm ² /s [2128 SUS]
Fluid cleanliness (mechanical activation)	23/19/16 (according to ISO 4406)		
Fluid cleanliness (PVE activation)	18/16/13 (according to ISO 4406)		
Operating temperature	Ambient: -30 to 60°C [-22 to 140°F]		

PVLA suction valve part number

PVLA suction valve	Plug
157B2001	157B2002

PVSP and PVSPM Priority Modules

The **PVSP** and **PVSPM** are work section modules with integrated priority functionality.

The PVSP/PVSPM modules advantages:

- Integrated priority function for the OSP steering unit and/or the working hydraulics PVB
- Compatibility with open center or closed center PVP inlet modules with flow up to 160 l/min

PVSP module



PVSP dimensions

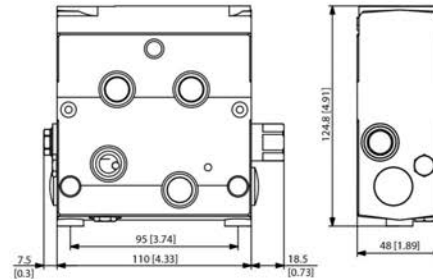

! Caution

The PVSP module must be installed as the **End module** of valve group instead of a PVS end plate.

PVSPM module



PVSPM dimensions

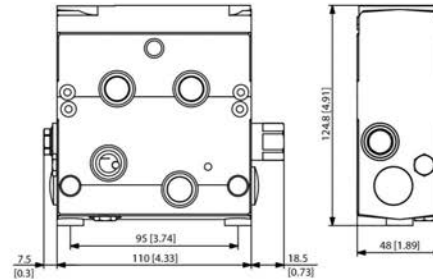

! Caution

The PVSPM must be installed as a **Mid-Inlet** module.

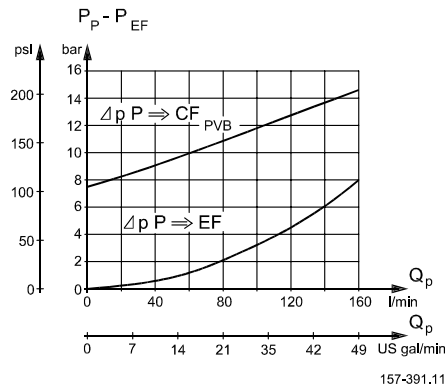
Technical Information
PVG 32 Proportional Valve Group
PVSP and PVSPM Priority Modules
PVSP/PVSPM pressure drop characteristics

PVSP and PSPVM Versions Overview

The generic PVSP/PVSPM priority module platform includes the main five versions: **Open Center: PVSP and PVSPM, Closed Center: PVSP and PVSPM; and Open/Closed Center PVSPM.**

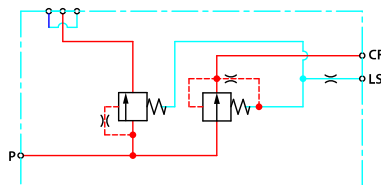
Compensator spool and shock valve has to be specified separately, see *Compensator spool for PVSP/PVSPM* on page 90.

Open Center PVSP module giving priority to OSP

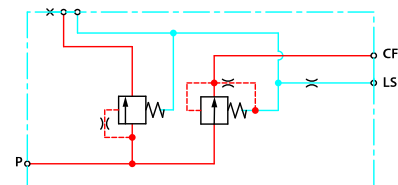
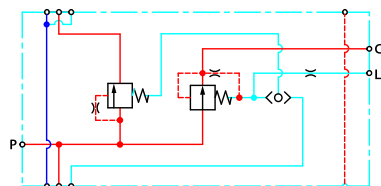
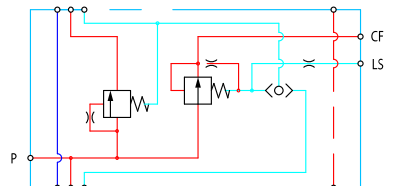
Prepared for PVLP 63 shock valve.

Closed Center PVSP module giving priority to OSP

Open Center PVSPM giving priority to OSP+PVB

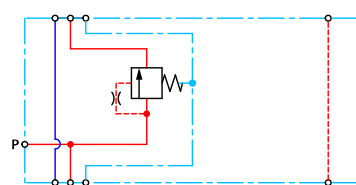
Closed Center PVSPM giving priority to OSP+PVB

Prepared for PVLP 63 shock valve.

Open/Closed Center PVSPM module giving priority to PVB

Technical Information
PVG 32 Proportional Valve Group

PVSP and PVSPM Priority Modules
Technical data

Maximum pump pressure	350 bar [5076 psi]
Maximum pump flow	160 l/min [42 US gal/min]
CF flow to OSP	60 l/min [12 US gal/min]
CF flow to PVB (PVSPM)	100 l/min [26.4 US gal/min]

PVSP/PSPVM part numbers

Part number	Type	CF-port	P-port	Weight
157B6708	Open center PVSP	G½"	G1"	3.8 kg [8.38 lb]
157B6808		7/8-14 UNF	1 5/16-12 UNF	
157B6728	Closed center PVSP	G½"	G1"	
157B6828		7/8-14 UNF	1 5/16-12 UNF	
157B6707	Open center PVSPM	G½"	G1"	
157B6727	Closed center PVSPM			
157B6709	Open/closed PVSPM			

PVSP and PVSPM Priority Modules
Sectional view of priority modules PVSP/PVSPM

The PVSP module can give priority to an OSP steering unit (or other valves) and/or to a PVB 32 module, and contains a P-connection for the pump and a CF-connection for flow control. The excessive flow is passed on through excess flow to non-prioritized PVB 32 basic modules.

PVSP/PVSPM sectional view

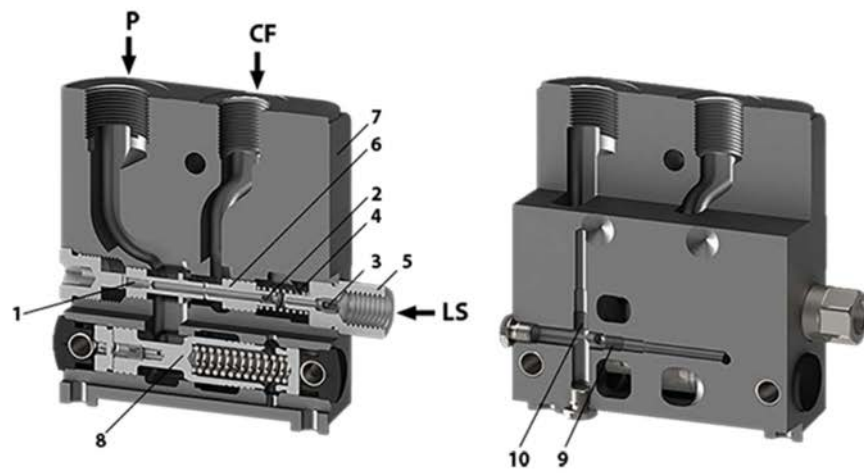

1. PP fixed orifice
2. Dynamic orifice
3. LS orifice for steering unit
4. Spring for compensator spool
5. Connection for LS-signal

6. Compensator spool for CF-connection
7. PVSP housing
8. Priority spool
9. Plug, open center
10. Plug, closed center steering unit

The standard pump connections in PVP and PVPVM must always be provided with a steel plug.

If priority is solely given to the OSP steering unit (**157B6708**, **157B6728**, **157B6808**, **157B6828**), the PVSP module fills in the place of end plate PVS(I). When specifying valve groups of this nature, you are therefore not to give in any code number for PVS.

In valve groups that must give priority to PVB 32 (max. one PVB), PVSPM must be mounted as Mid-Inlet (**157B6707**, **157B6727**, **157B6709**). The PVB module that is given priority must be turned a 180° and installed on the right of PVSP, see orientation of ports in dimension drawings.

In closed center systems, the system relief valve in PVP opens at a higher pressure (max. 20 bar) on the prioritized functions. It is therefore recommended to use PVB and OSP with integrated relief valve.

If an OSP steering unit and a PVB working function are given priority at the same time (PVSPM, **157B6707**, **157B6727**), it is necessary to ensure that the OSP will always have an adequate pump flow available.

In prioritized PVB modules, always remember to dismantle the LS shuttle valve. And together with prioritized PVB modules, always use end plate **157B2018** (without O-rings).

In open center systems, prioritized PVB modules and steering units must always embody an integrated relief valve to avoid that an unintended, high pressure buildup.

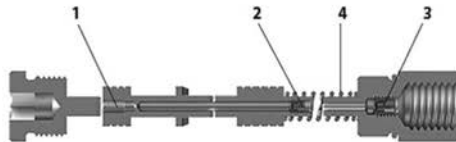
PVSP and PVSPM Priority Modules
Compensator spool for PVSP/PVSPM
Compensator spool sectional view

1. PP internal fixed orifice: 0.6 mm [0.024 in]
2. Dynamic orifice: 0.9 or 1 mm [0.035 in]
3. LS orifice EU: G¼" or US: 9/16-18 UNF
4. Spring

Part numbers for compensator spool with dynamic orifice

Part number	Dynamic orifice	LS orifice	Spring
157B7900	0.9 mm	1.2 mm	7 bar
157B7902		–	
157B7904		1.2 mm	10 bar
157B7903	1.0 mm	–	7 bar
157B7905		0.047 in	101.5 psi
157B7950*	0.035 in	0.047 in	101.5 psi

* US version.

Part numbers for compensator spool with static LS

Part number	Dynamic orifice	LS orifice	Spring
157B7901	Plug	1.2 mm	7 bar
157B7951*	Plug	0.047 in	101.5 psi

* US version.

Technical Information
PVG 32 Proportional Valve Group
PVBD Diverter Module

The PVBD is a diverter module to be mounted on top of PVB or PVBZ modules to enlarge the application range of the work section up to 2 functions.

- Pilot operated with PVC
- Auxiliary valve on tractors for function control on implements
- Cylinder positioning when the demand on neutral port leakage is limited

PVBD Diverter Module

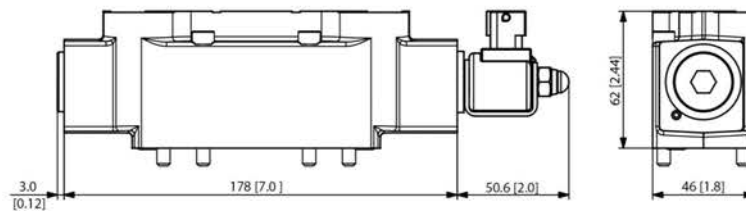
PVBD Dimensions

PVBD Diverter Principle
PVC off:

The shift spool is held in position (flow to A1/B1) by the spring in the right-hand side (opposite the PVC). The spring chamber is always connected to the T0 gallery in the PVBZ body.

PVC on:

Pilot pressure is led into the chamber next to the PVC. A limited flow is passing through the shift spool and the two orifices and into the spring chamber connected to T0. Pressure-drop across the orifices creates the shift force moving the shift spool towards the spring. As a result, port A2/B2 becomes active.

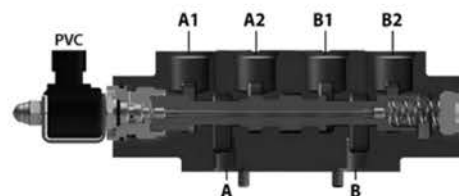
Leakage (along the spool clearance) from pressurized work ports A1/B1 or A2/B2 will always be drained to T0 either directly in the spring chamber or through the shift spool. This secures safe positioning of the shift spool as leakage never will build up pressure up in the control chambers.

PVBD sectional view

Safety recommendation

Shift of the diverter should only be possible when the main spool is in neutral. This has to be ensured through a proper set-up in the controller/MMI hardware.

Technical Information
PVG 32 Proportional Valve Group
PVBD Diverter Module
PVBD Diverter Module Overview

PVBD Diverter Modules are actuated with included PVC solenoid; NC and have two variants: PVBD 6/2 shift valve and Multi-valve for PVBZ **11032961**.

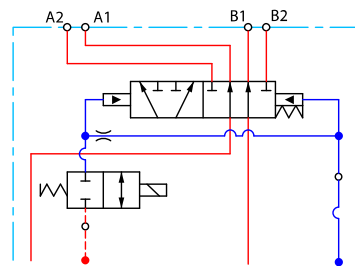
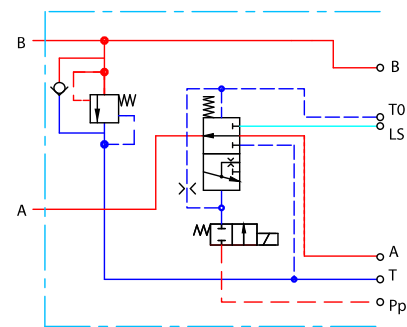
- PVBD 6/2 shift valve shifts between A1 & B1 / A2 & B2
- Multi-valve for PVBZ shifts A-port between PVBZ or tank gallery, for example between single and double acting actuation. B-port is prepared for PVLP.

PVBD schematic

Multi-valve schematic

Technical data

Description	PVBD 6/2 shift	Multi-valve for PVBZ
Oil flow max. recommended	80 l/min [21.1 US gal/min]	100 l/min [26.4 US gal/min]
Max. port pressure	280 bar [4061 psi]	
Voltage Supply	12 V _{DC} ; 14 bar	
Connector type	AMP JPT 2-pin	

Part numbers for PVBD diverter

Part numbers for 6/2 shift	157B1501	157B1503
Part number for Multi-valve	11027604	—
Port size	M22 x 1.5 mm	7/8-14 UNF

PVE Series 7 extension plates

When mounting a diverter with a PVE, an extension plate is necessary in order to prevent the connector of the PVE from interfering with the diverter.

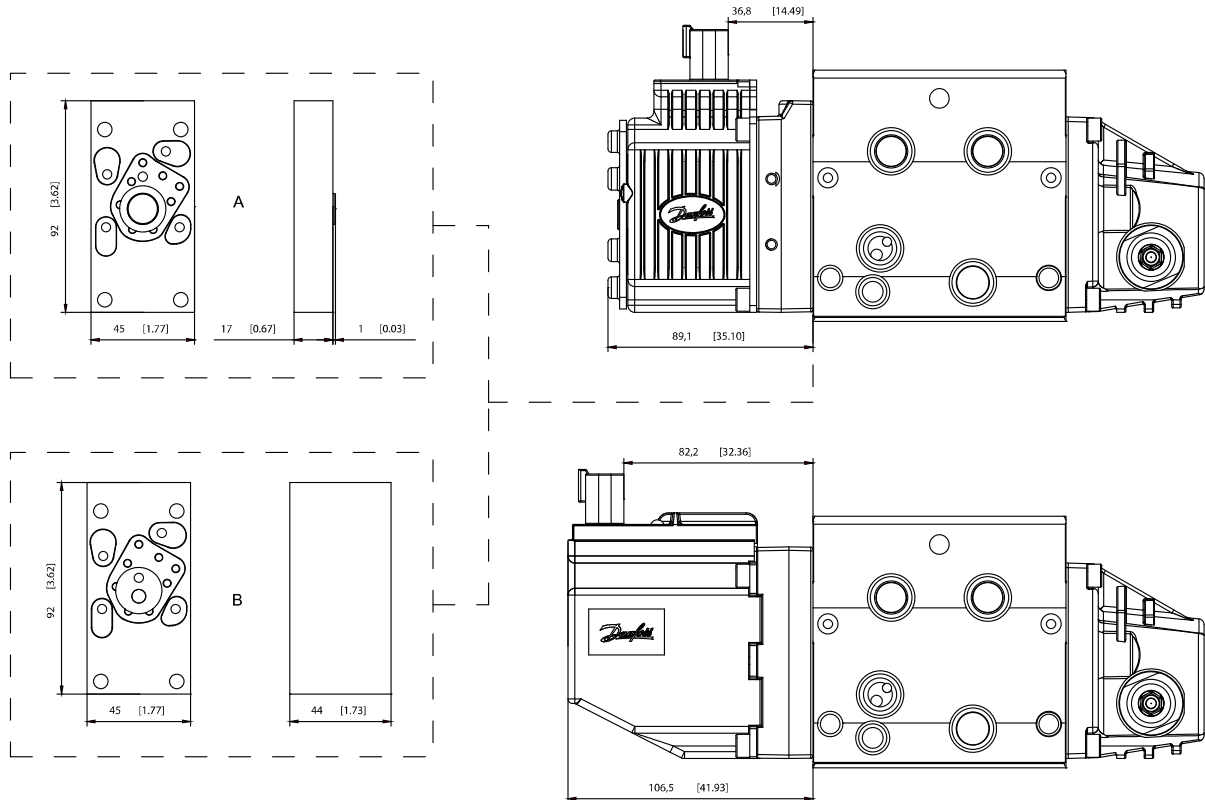
Technical Information
PVG 32 Proportional Valve Group
PVBD Diverter Module

Part number	Description	Letter
11189080	17 mm aluminum block + seal kit	A
11189081	44 mm aluminum block + seal kit	B

PVBS Main Spools

The main spools (PVBS) determine the flow out of the work section or the pressure build up, and are based on a generic platform with a wide selection of additional features, enabling you to tailor the PVBS to suit the demands of any hydraulic system and any function.

The PVBS main spool can be activated in three different ways:

- Mechanically by a PVM lever
- Electrically by a PVE/PVHC actuator
- Hydraulically by a PVH actuator

PVBS main spool

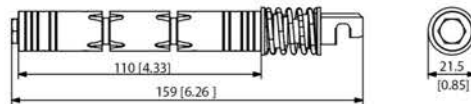
PVBS main spool dimensions

Weight: 0.25 kg [0.55 lb]

Technical specification

Parameter	Minimum	Recommended range	Maximum
Fluid temperature	-30°C [-22°F]	30 to 60°C [86 to 140°F]	90° [194°F]
Fluid viscosity	4 mm ² /s [39 SUS]	12 to 75 mm ² /s [65 to 347 SUS]	460 mm ² /s [2128 SUS]
Fluid cleanliness (mechanical activation)	23/19/16 (according to ISO 4406)		
Fluid cleanliness (PVE activation)	18/16/13 (according to ISO 4406)		
Operating temperature	Ambient: -30 to 60°C [-22 to 140°F]		

Flow Control Spools (FC) Flow control spools are for work sections where you want to control the speed (flow) of the work port

Pressure Control Spools (PC) Pressure control spools are for work sections where you want to control the power (pressure) of the work port

For more information on where to use flow control or pressure control spools see application guide [AB224686484921](#) - "Using flow or pressure control spools"

Regenerative Spool (Regen) Regenerative spools means the oil returning in one port will be led to the other port to increase portflow and save pump flow

For more information on regenerative spools see data sheet AI00000134 - "PVBS 32, Regenerative Spool Data Sheet"

Closed neutral position In neutral position and inside of the deadband area the connection to tank is closed

Throttled open neutral position In neutral position and inside of the deadband area the connection to tank is 10 % of the full flow function

Technical Information
PVG 32 Proportional Valve Group
PVBS Main Spools
Open/closed neutral position (drain)

In total neutral position the connection to tank is less than 10 % of the full flow function. But when moving the spool out of neutral position but still within dead band area the connection will close.

PVBS fluid flow characteristics—Theoretical performance

Fluid flow at different spool travel + 10 bar margin - uncompensated PVB

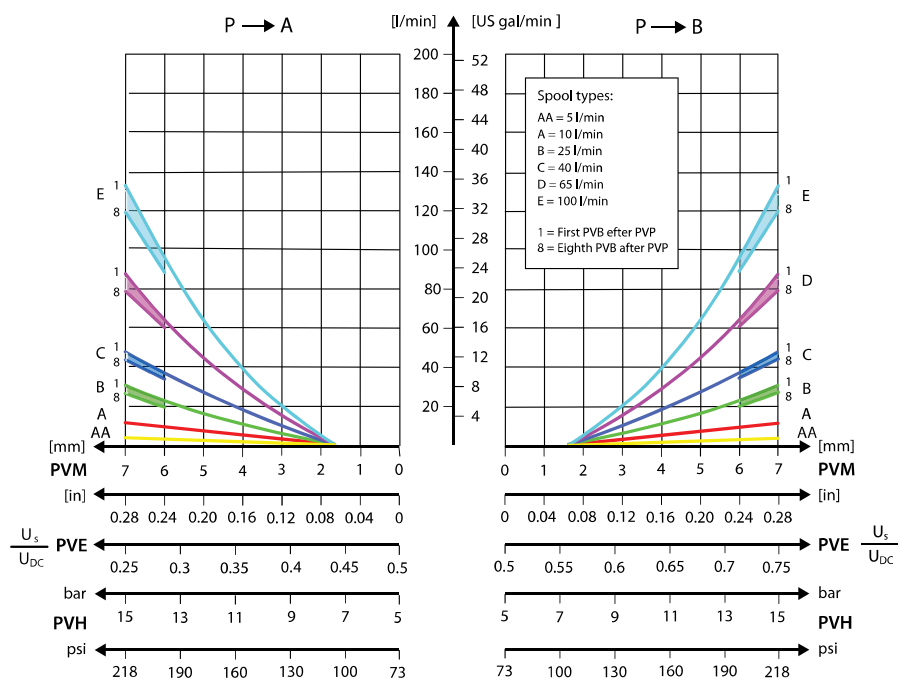

Technical Information
PVG 32 Proportional Valve Group

PVBS Main Spools

Fluid flow at different spool travel + 20 bar margin - uncompensated PVB

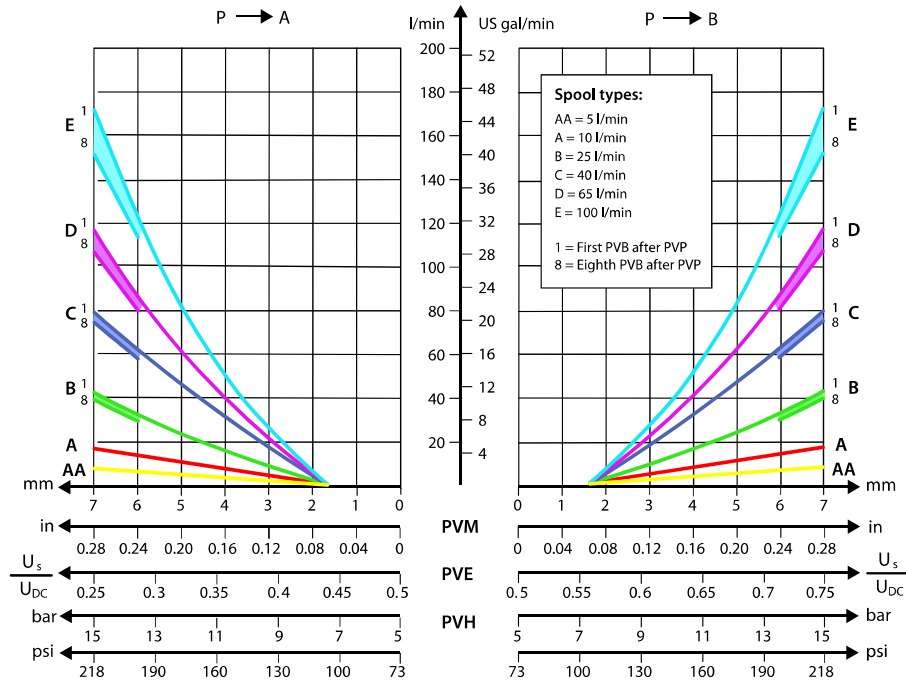

Technical Information
PVG 32 Proportional Valve Group

PVBS Main Spools

Progressive fluid flow characteristic depending on spool type

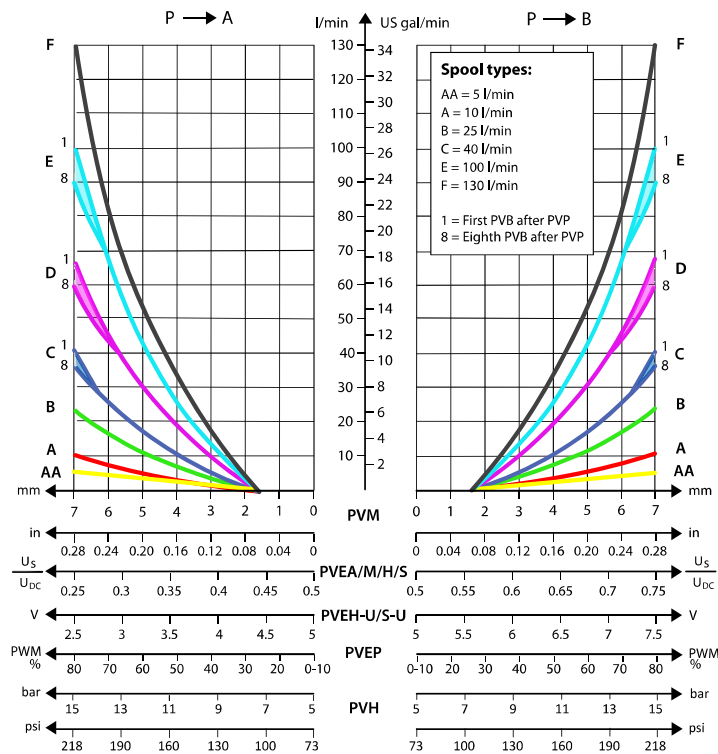

Linear fluid flow characteristic depending on spool type

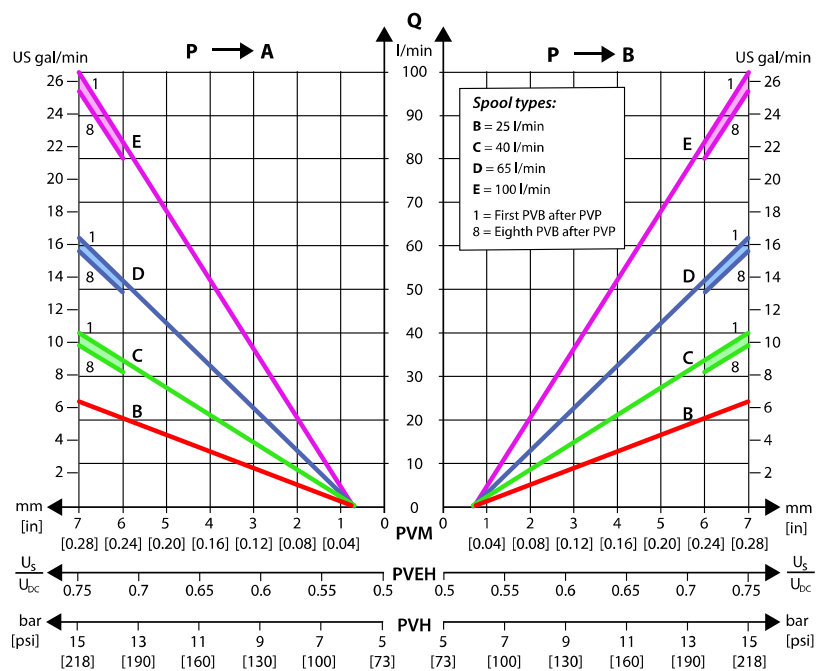

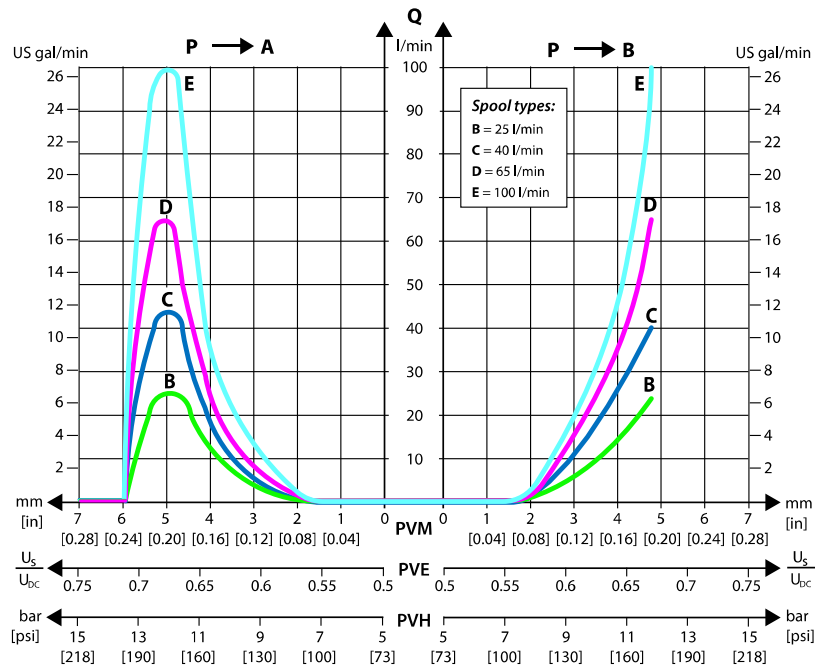
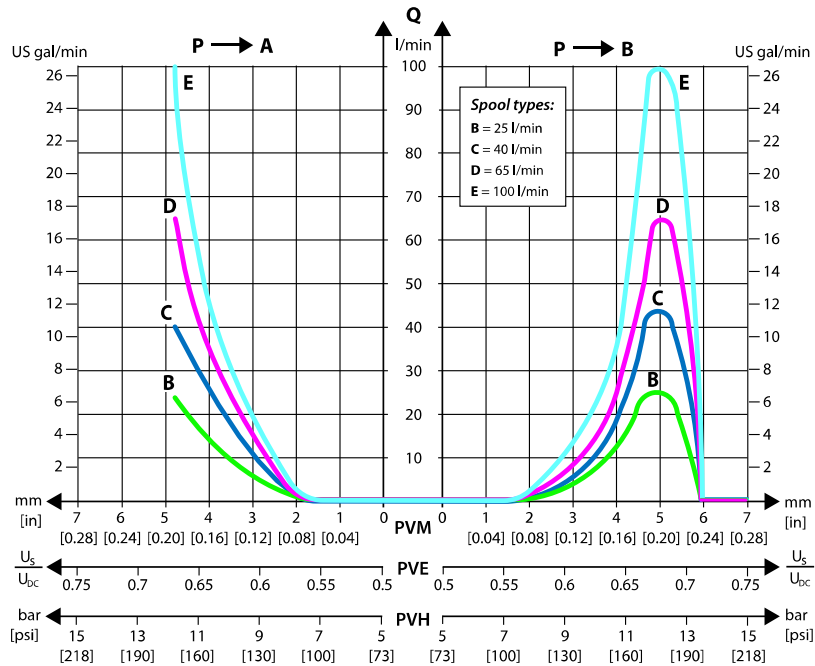
Technical Information
PVG 32 Proportional Valve Group
PVBS Main Spools
Progressive fluid flow characteristic of spool with A-float

Progressive fluid flow characteristic of spool with B-float

Technical Information
PVG 32 Proportional Valve Group

PVBS Main Spools

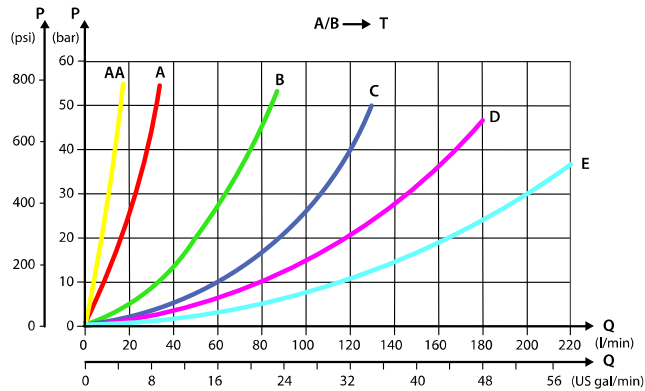
Pressure drop at maximum spool travel position



Pressure drop for open spool in neutral position

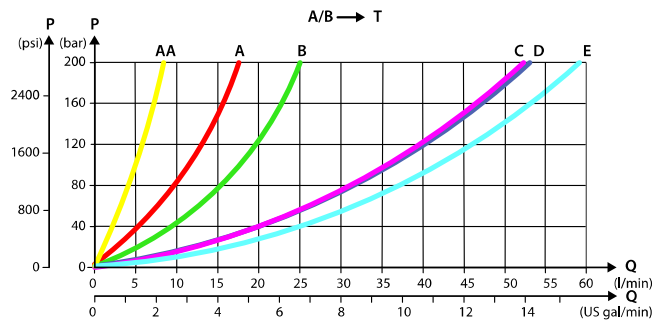

Pressure drop A/B to T in float position

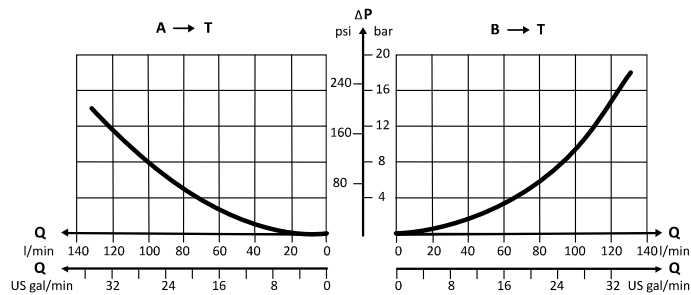

PVBS Main Spools
Pressure control spool characteristics - Theoretical performance

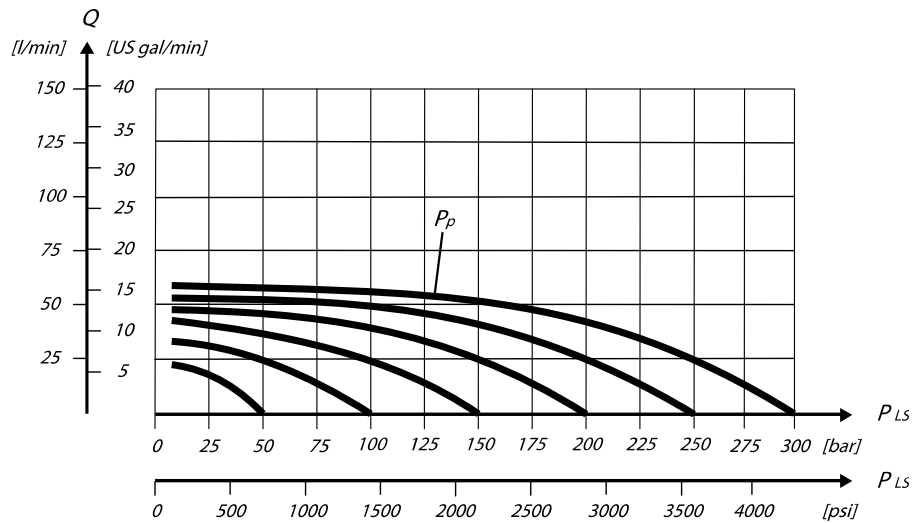
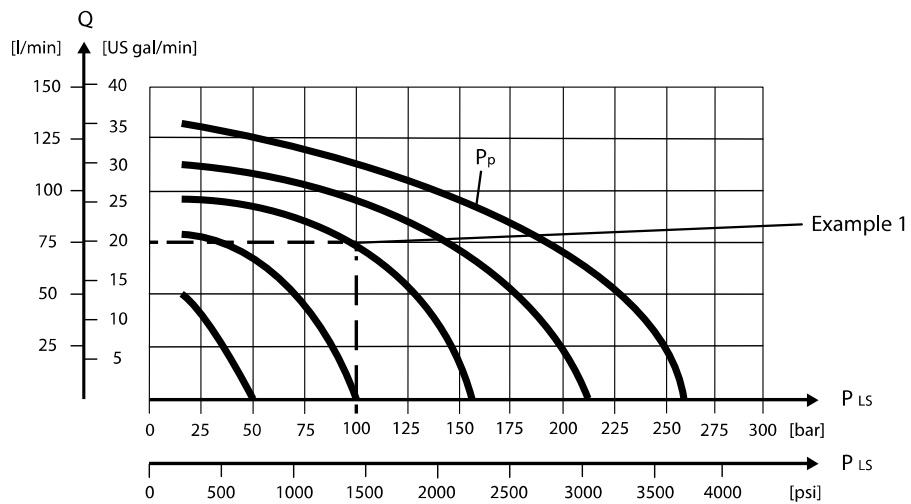
 Pressure control spools **Size A 10 l/min [2.6 US gal/min]**

 Pressure control spools **Size B 25 l/min [6.6 US gal/min]**

Example 1: Determining the oil flow
Given:

- Spool type B: **25 l/min [6.6 US gal/min]**
- Pressure setting P_p : **160 bar [2320 psi]**
- Load pressure, $LS_{A/B}$: **100 bar [1450 psi]**

Result:

Technical Information
PVG 32 Proportional Valve Group
PVBS Main Spools

- Oil flow = 75 l/min [19.8 US gal/min]

Pressure control spools **Size C 40 l/min [10.6 US gal/min]**

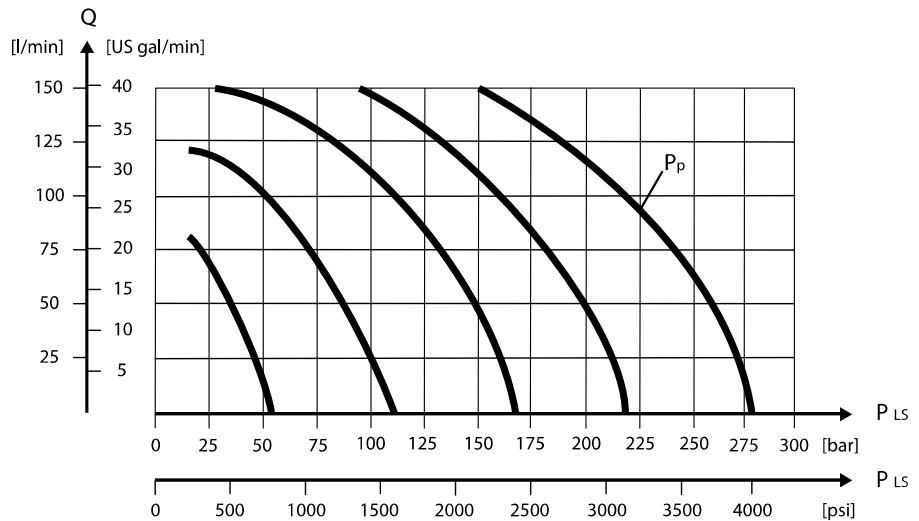

Pressure control spools **Size D 65 l/min [17.2 US gal/min]**

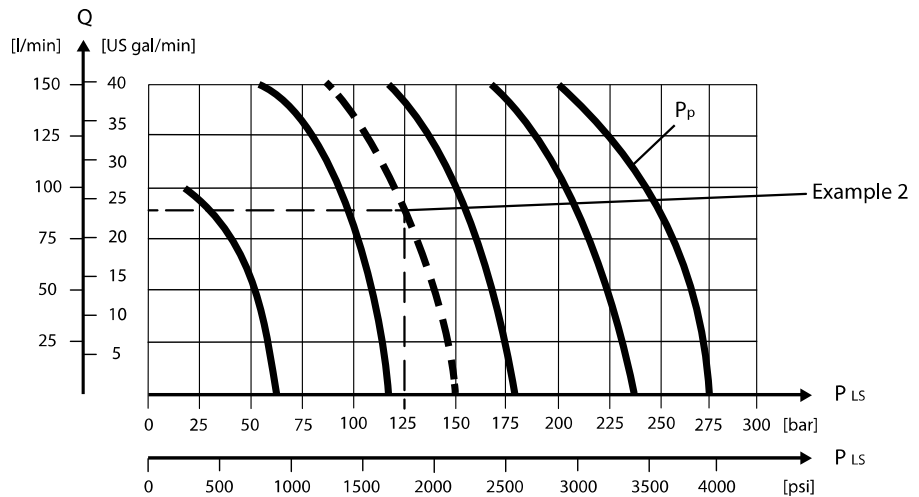
Example 2: Determining the spool size
Given:

- Max oil flow: **90 l/min [23.8 US gal/min]**
- Pressure setting P_p : **150 bar [2175 psi]**
- Load pressure, $LS_{A/B}$: **125 bar [1810 psi]**

Result:

Technical Information
PVG 32 Proportional Valve Group
PVBS Main Spools

- D spool, 65 l/min [17.2 US gal/min]

Pressure control spools **Size E 100 l/min [26.4 US gal/min]**

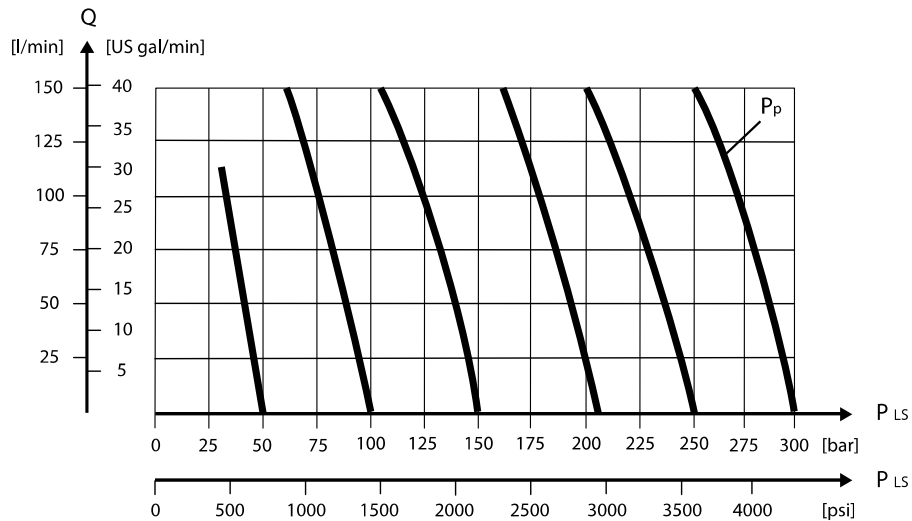

Normally a smaller spool can be chosen with pressure control. It is our experience that the spool can be one size smaller than with the normal flow control.

Technical Information
PVG 32 Proportional Valve Group
PVBS Main Spools Part Numbers
Flow Control Spools—Closed Neutral Position

Schematic for PVBS without shuttle valve

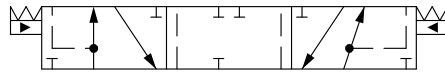

Schematic for PVBS with shuttle valve

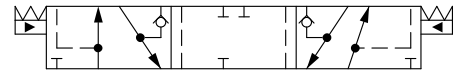

Part numbers for Symmetric Flow Control Spools

Part Number	Actuation	PVB with shuttle valve	Flow – l/min [US gal/min]			
			A → T	P → A	P → B	B → T
157B9672	PVE	-	1 [0,26]	1 [0,26]	1 [0,26]	1 [0,26]
157B7005	PVE	-	5 [1,3]	5 [1,3]	5 [1,3]	5 [1,3]
157B9543	PVE	-	10 [2,6]	5 [1,3]	5 [1,3]	10 [2,6]
157B7000	PVE	-	10 [2,6]	10 [2,6]	10 [2,6]	10 [2,6]
157B9509	PVE	-	15 [4,0]	15 [4,0]	15 [4,0]	15 [4,0]
157B7001	PVE	-	25 [6,6]	25 [6,6]	25 [6,6]	25 [6,6]
157B7002	PVE	-	40 [10,6]	40 [10,6]	40 [10,6]	40 [10,6]
157B7003	PVE	-	65 [17,2]	65 [17,2]	65 [17,2]	65 [17,2]
157B9920	PVE	-	75 [19,8]	75 [19,8]	75 [19,8]	130 [34,3]
157B7004	PVE	-	100 [26,4]	100 [26,4]	100 [26,4]	100 [26,4]
157B9977	PVE	-	100 [26,4]	100 [26,4]	100 [26,4]	130 [34,3]
157B9674	PVE	-	130 [34,3]	100 [26,4]	100 [26,4]	100 [26,4]
157B9503	PVE	-	¹⁾	100 [26,4]	100 [26,4]	100 [26,4]
157B7006 ²⁾	PVE	-	130 [34,3]	130 [34,3]	130 [34,3]	130 [34,3]
11137391	PVE	Yes	1 [0,26]	1 [0,26]	1 [0,26]	1 [0,26]
157B7025	PVE	Yes	5 [1,3]	5 [1,3]	5 [1,3]	5 [1,3]
157B7020	PVE	Yes	10 [2,6]	10 [2,6]	10 [2,6]	10 [2,6]
11225588	PVE	Yes	15 [4,0]	15 [4,0]	15 [4,0]	15 [4,0]
157B7021	PVE	Yes	25 [6,6]	25 [6,6]	25 [6,6]	25 [6,6]
157B7022	PVE	Yes	40 [10,6]	40 [10,6]	40 [10,6]	40 [10,6]
157B7023	PVE	Yes	65 [17,2]	65 [17,2]	65 [17,2]	65 [17,2]
11212900	PVE	Yes	80 [21.1]	80 [21.1]	80 [21.1]	80 [21.1]
157B7024	PVE	Yes	100 [26,4]	100 [26,4]	100 [26,4]	100 [26,4]
157B7026	PVE	Yes	130 [34,3]	130 [34,3]	130 [34,3]	130 [34,3]
157B9005	PVH/PVHC	-	5 [1,3]	5 [1,3]	5 [1,3]	5 [1,3]
157B9000	PVH/PVHC	-	10 [2,6]	10 [2,6]	10 [2,6]	10 [2,6]
11225674	PVH/PVHC	-	15 [4,0]	15 [4,0]	15 [4,0]	15 [4,0]
157B9001	PVH/PVHC	-	25 [6,6]	25 [6,6]	25 [6,6]	25 [6,6]
157B9002	PVH/PVHC	-	40 [10,6]	40 [10,6]	40 [10,6]	40 [10,6]
157B9003	PVH/PVHC	-	65 [17,2]	65 [17,2]	65 [17,2]	65 [17,2]
157B9004	PVH/PVHC	-	100 [26,4]	100 [26,4]	100 [26,4]	100 [26,4]
157B9006 ²⁾	PVH/PVHC	-	130 [34,3]	130 [34,3]	130 [34,3]	130 [34,3]
157B9025	PVH/PVHC	Yes	5 [1,3]	5 [1,3]	5 [1,3]	5 [1,3]

PVBS Main Spools Part Numbers
Part numbers for Symmetric Flow Control Spools (continued)

Part Number	Actuation	PVB with shuttle valve	Flow – l/min [US gal/min]			
			A → T	P → A	P → B	B → T
157B9020	PVH/PVHC	Yes	10 [2,6]	10 [2,6]	10 [2,6]	10 [2,6]
11122055	PVH/PVHC	Yes	15 [4,0]	15 [4,0]	15 [4,0]	15 [4,0]
157B9021	PVH/PVHC	Yes	25 [6,6]	25 [6,6]	25 [6,6]	25 [6,6]
157B9022	PVH/PVHC	Yes	40 [10,6]	40 [10,6]	40 [10,6]	40 [10,6]
157B9023	PVH/PVHC	Yes	65 [17,2]	65 [17,2]	65 [17,2]	65 [17,2]
157B9024	PVH/PVHC	Yes	100 [26,4]	100 [26,4]	100 [26,4]	100 [26,4]
157B9026 ²⁾	PVH/PVHC	Yes	130 [34,3]	130 [34,3]	130 [34,3]	130 [34,3]

¹⁾ Fully opened, no flow restriction notch.

²⁾ Turbo on A and B port.

Part numbers for Asymmetric Flow Control Spools

Part Number	Actuation	PVB with shuttle valve	Flow – l/min [US gal/min]			
			A → T	P → A	P → B	B → T
157B9524	PVE	-	5 [1,3]	5 [1,3]	10 [2,6]	10 [2,6]
11004213	PVE	-	5 [1,3]	5 [1,3]	65 [17,2]	65 [17,2]
157B9092	PVE	-	10 [2,6]	10 [2,6]	5 [1,3]	5 [1,3]
157B9514	PVE	-	10 [2,6]	10 [2,6]	15 [4,0]	15 [4,0]
157B9579	PVE	-	10 [2,6]	10 [2,6]	65 [17,2]	65 [17,2]
11129526	PVE	-	65 [17,2]	10 [2,6]	65 [17,2]	65 [17,2]
157B9856	PVE	-	15 [4,0]	15 [4,0]	10 [2,6]	10 [2,6]
157B9516	PVE	-	15 [4,0]	15 [4,0]	10 [2,6]	10 [2,6]
11137748	PVE	-	20 [5,3]	20 [5,3]	15 [4,0]	15 [4,0]
157B9515	PVE	-	20 [5,3]	20 [5,3]	25 [6,6]	25 [6,6]
11130056	PVE	-	25 [6,6]	25 [6,6]	15 [4,0]	15 [4,0]
157B9975	PVE	-	100 [26,4]	25 [6,6]	100 [26,4]	100 [26,4]
11119792	PVE	-	40 [10,6]	40 [10,6]	25 [6,6]	25 [6,6]
11022810	PVE	-	65 [17,2]	65 [17,2]	40 [10,6]	40 [10,6]
157B9566	PVE	-	65 [17,2]	65 [17,2]	10 [2,6]	10 [2,6]
11119557	PVE	-	75 [19,8]	75 [19,8]	65 [17,2]	65 [17,2]
157B9947	PVE	Yes	5 [1,3]	5 [1,3]	25 [6,6]	25 [6,6]
157B9555	PVE	Yes	7 [1,8]	7 [1,8]	10 [2,6]	10 [2,6]
11212898	PVE	Yes	10 [2,6]	10 [2,6]	5 [1,3]	5 [1,3]
157B9915	PVE	Yes	15 [4,0]	15 [4,0]	35 [9,2]	35 [9,2]
11088763	PVE	Yes	25 [6,6]	25 [6,6]	40 [10,6]	40 [10,6]
11078499	PVE	Yes	40 [10,6]	25 [6,6]	40 [10,6]	40 [10,6]
157B9810	PVE	Yes	30 [7,9]	30 [7,9]	20 [5,3]	20 [5,3]
11015763	PVE	Yes	40 [10,6]	40 [10,6]	25 [6,6]	25 [6,6]
11015765	PVE	Yes	40 [10,6]	40 [10,6]	65 [17,2]	65 [17,2]

PVBS Main Spools Part Numbers
Part numbers for Asymmetric Flow Control Spools (continued)

Part Number	Actuation	PVB with shuttle valve	Flow – l/min [US gal/min]			
			A → T	P → A	P → B	B → T
157B9907	PVE	Yes	50 [13,2]	50 [13,2]	5 [1,3]	5 [1,3]
157B9828	PVE	Yes	65 [17,2]	65 [17,2]	40 [10,6]	40 [10,6]
11021888	PVE	Yes	65 [17,2]	65 [17,2]	40 [10,6]	65 [17,2]
11036502	PVE	Yes	100 [26,4]	100 [26,4]	65 [17,2]	65 [17,2]
157B9857 ¹⁾	PVE	Yes	130 [34,3]	130 [34,3]	65 [17,2]	65 [17,2]
11119552	PVH/PVHC	-	15 [4,0]	15 [4,0]	10 [2,6]	10 [2,6]
11066371	PVH/PVHC	-	20 [5,3]	20 [5,3]	15 [4,0]	15 [4,0]
11130928	PVH/PVHC	-	25 [6,6]	25 [6,6]	15 [4,0]	15 [4,0]
11130924	PVH/PVHC	-	40 [10,6]	40 [10,6]	25 [6,6]	25 [6,6]
11130831	PVH/PVHC	-	75 [19,8]	75 [19,8]	65 [17,2]	65 [17,2]
11219179	PVH/PVHC	Yes	40 [10,6]	40 [10,6]	25 [6,6]	25 [6,6]
157B9091	PVH/PVHC	Yes	5 [1,3]	5 [1,3]	50 [13,2]	50 [13,2]
11305766	PVH/PVHC	Yes	5 [1,3]	5 [1,3]	65 [17,2]	65 [17,2]
11248801	PVH/PVHC	Yes	25 [6,6]	25 [6,6]	10 [2,6]	10 [2,6]
11263817	PVH/PVHC	Yes	40 [10,6]	40 [10,6]	65 [17,2]	65 [17,2]
11239804	PVH/PVHC	Yes	65 [17,2]	65 [17,2]	40 [10,6]	40 [10,6]
11188062	PVH/PVHC	Yes	100 [26,4]	100 [26,4]	40 [10,6]	40 [10,6]
11288253	PVH/PVHC	Yes	100 [26,4]	100 [26,4]	65 [17,2]	65 [17,2]
11123224	PVH/PVHC	Yes	130 [34,3]	130 [34,3]	65 [17,2]	65 [17,2]
157B9084	PVH/PVHC	Yes	50 [13,2]	50 [13,2]	5 [1,3]	5 [1,3]

¹⁾ Turbo on A and B port.

Part numbers for Back pressure Flow Control Spools (A/B->T flow track smaller than P->A/B)

Part Number	Actuation	PVB with shuttle valve	Flow – l/min [US gal/min]			
			A → T	P → A	P → B	B → T
11084778	PVE	-	2 [0,53]	10 [2,6]	10 [2,6]	5 [1,3]
11104114	PVE	-	3 [0,79]	10 [2,6]	15 [4,0]	5 [1,3]
11075794	PVE	-	5 [1,3]	10 [2,6]	5 [1,3]	10 [2,6]
11098883	PVE	-	5 [1,3]	10 [2,6]	10 [2,6]	2 [0,53]
11104452	PVE	-	5 [1,3]	15 [4,0]	10 [2,6]	3 [0,79]
157B9633	PVE	-	5 [1,3]	25 [6,6]	25 [6,6]	5 [1,3]
11098881	PVE	-	5 [1,3]	25 [6,6]	25 [6,6]	25 [6,6]
11126414	PVE	-	10 [2,6]	25 [6,6]	25 [6,6]	25 [6,6]
11129522	PVE	-	10 [2,6]	25 [6,6]	50 [13,2]	25 [6,6]
157B9952	PVE	-	25 [6,6]	38 [10,0]	38 [10,0]	25 [6,6]
157B9635	PVE	-	10 [2,6]	40 [10,6]	40 [10,6]	25 [6,6]
11129523	PVE	-	10 [2,6]	40 [10,6]	50 [13,2]	40 [10,6]
157B9638	PVE	-	25 [6,6]	40 [10,6]	40 [10,6]	25 [6,6]

PVBS Main Spools Part Numbers
Part numbers for Back pressure Flow Control Spools (A/B->T flow track smaller than P->A/B) (continued)

Part Number	Actuation	PVB with shuttle valve	Flow - l/min [US gal/min]			
			A → T	P → A	P → B	B → T
157B9818	PVE	-	40 [10,6]	55 [14,5]	55 [14,5]	40 [10,6]
157B9634	PVE	-	25 [6,6]	65 [17,2]	65 [17,2]	25 [6,6]
11124636	PVE	-	40 [10,6]	65 [17,2]	65 [17,2]	40 [10,6]
157B9931	PVE	-	40 [10,6]	65 [17,2]	65 [17,2]	65 [17,2]
157B9551	PVE	-	65 [17,2]	65 [17,2]	65 [17,2]	10 [2,6]
157B9978	PVE	-	100 [26,4]	65 [17,2]	100 [26,4]	40 [10,6]
157B9541	PVE	-	40 [10,6]	100 [26,4]	65 [17,2]	*
11129528	PVE	Yes	5 [1,3]	15 [4,0]	20 [5,3]	10 [2,6]
157B9827	PVE	Yes	10 [2,6]	20 [5,3]	20 [5,3]	10 [2,6]
157B9863	PVE	Yes	5 [1,3]	25 [6,6]	25 [6,6]	5 [1,3]
11100489	PVE	Yes	5 [1,3]	25 [6,6]	40 [10,6]	20 [5,3]
157B9946	PVE	Yes	25 [6,6]	25 [6,6]	10 [2,6]	10 [2,6]
157B9858	PVE	Yes	10 [2,6]	40 [10,6]	40 [10,6]	10 [2,6]
157B9639	PVE	Yes	25 [6,6]	40 [10,6]	40 [10,6]	25 [6,6]
157B9906	PVE	Yes	30 [7,9]	40 [10,6]	15 [4,0]	20 [5,3]
157B9632	PVE	Yes	25 [6,6]	65 [17,2]	65 [17,2]	25 [6,6]
157B9640	PVE	Yes	40 [10,6]	100 [26,4]	100 [26,4]	100 [26,4]
157B9839	PVH/PVHC	-	5 [1,3]	25 [6,6]	25 [6,6]	5 [1,3]
11104487	PVH/PVHC	-	5 [1,3]	25 [6,6]	25 [6,6]	25 [6,6]
11111729	PVH/PVHC	-	25 [6,6]	40 [10,6]	40 [10,6]	25 [6,6]
11234469	PVH/PVHC	-	65 [17,2]	65 [17,2]	65 [17,2]	10 [2,6]
11218880	PVH/PVHC	Yes	5 [1,3]	25 [6,6]	25 [6,6]	5 [1,3]
11119474	PVH/PVHC	Yes	25 [6,6]	40 [10,6]	40 [10,6]	25 [6,6]

* Fully opened, no flow restriction notch.

Part numbers for Flow Control Spools for PVML

Part Number	Actuation	PVB with shuttle valve	Flow - l/min [US gal/min]			
			A → T	P → A	P → B	B → T
11088178	PVE	-	65 [17,2]	65 [17,2]	65 [17,2]	65 [17,2]
11076336	PVE	-	100 [26,4]	100 [26,4]	100 [26,4]	100 [26,4]
11088177	PVE	Yes	100 [26,4]	100 [26,4]	100 [26,4]	100 [26,4]
11247367	PVH/PVHC	-	25 [6,6]	25 [6,6]	25 [6,6]	25 [6,6]
11212762	PVH/PVHC	-	40 [10,6]	40 [10,6]	40 [10,6]	40 [10,6]
11254993	PVH/PVHC	-	100 [26,4]	100 [26,4]	100 [26,4]	100 [26,4]
11314101	PVH/PVHC	Yes	25 [6,6]	25 [6,6]	25 [6,6]	25 [6,6]
11079716	PVH/PVHC	Yes	75 [19,8]	75 [19,8]	75 [19,8]	75 [19,8]
11314142	PVH/PVHC	Yes	90 [23,8]	90 [23,8]	90 [23,8]	90 [23,8]

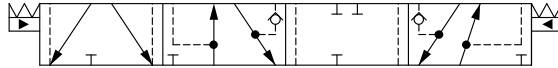
Technical Information
PVG 32 Proportional Valve Group
PVBS Main Spools Part Numbers
Flow Control Spools—Closed Neutral Position with A-float
Schematic for PVBS with shuttle valve

Part numbers for Symmetric Flow Control Spools

Part Number	Actuation	PVB with shuttle valve	Flow - l/min [US gal/min]			
			A → T	P → A	P → B	B → T
11251672	PVE	Yes	10 [2,6]	10 [2,6]	10 [2,6]	10 [2,6]
11251668	PVE	Yes	25 [6,6]	25 [6,6]	25 [6,6]	25 [6,6]
11177587	PVE	Yes	65 [17,2]	65 [17,2]	65 [17,2]	65 [17,2]

Part numbers for Asymmetric Flow Control Spools

Part Number	Actuation	PVB with shuttle valve	Flow - l/min [US gal/min]			
			A → T	P → A	P → B	B → T
11020293 ¹	PVE	B-Port	*	100 [26,4]	65 [17,2]	*

¹ Deadband 0,8 mm [0,03 in]

* Fully opened, no flow restriction notch

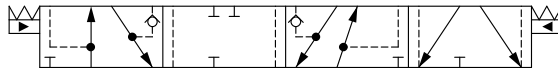
Flow Control Spools—Closed Neutral Position with B-float
Schematic for PVBS with shuttle valve

Part numbers for Symmetric Flow Control Spools

Part Number	Actuation	PVB with shuttle valve	Flow - l/min [US gal/min]			
			A → T	P → A	P → B	B → T
11324302	PVE	Yes	5 [1,3]	5 [1,3]	5 [1,3]	5 [1,3]
157B7620	PVE	Yes	10 [2,6]	10 [2,6]	10 [2,6]	10 [2,6]
157B7621	PVE	Yes	25 [6,6]	25 [6,6]	25 [6,6]	25 [6,6]
157B7622	PVE	Yes	40 [10,6]	40 [10,6]	40 [10,6]	40 [10,6]
157B7623	PVE	Yes	65 [17,2]	65 [17,2]	65 [17,2]	65 [17,2]
157B7624 ¹	PVE	Yes	100 [26,4]	100 [26,4]	100 [26,4]	100 [26,4]
157B9941 ¹	PVE	Yes	130 [34,3]	130 [34,3]	130 [34,3]	130 [34,3]
157B9620	PVH/PVHC	Yes	10 [2,6]	10 [2,6]	10 [2,6]	10 [2,6]
157B9636	PVH/PVHC	Yes	25 [6,6]	25 [6,6]	25 [6,6]	25 [6,6]
11051805	PVH/PVHC	Yes	65 [17,2]	65 [17,2]	65 [17,2]	65 [17,2]
11085501 ¹	PVH/PVHC	Yes	100 [26,4]	100 [26,4]	100 [26,4]	100 [26,4]

¹ Turbo on A and B port.

PVBS Main Spools Part Numbers
Part numbers for Asymmetric Flow Control Spools

Part Number	Actuation	PVB with shuttle valve	Flow - l/min [US gal/min]			
			A → T	P → A	P → B	B → T
157B9911	PVE	Yes	30 [7,9]	30 [7,9]	65 [17,2]	65 [17,2]
11229294	PVE	Yes	40 [10,6]	40 [10,6]	25 [6,6]	25 [6,6]
157B9518¹	PVE	Yes	100 [26,4]	100 [26,4]	65 [17,2]	100 [26,4]

¹ Turbo on A port.

Part numbers for Back pressure Flow Control Spools (A/B->T flow track smaller than P->A/B)

Part Number	Actuation	PVB with shuttle valve	Flow - l/min [US gal/min]			
			A → T	P → A	P → B	B → T
11129529	PVE	Yes	3 [0,8]	10 [2,6]	13 [3,4]	5 [1,3]
157B9691	PVE	Yes	15 [4,0]	30 [7,9]	30 [7,9]	15 [4,0]
157B9692	PVE	Yes	25 [6,6]	50 [13,2]	65 [17,2]	65 [17,2]
157B9691	PVH/PVHC	Yes	15 [4,0]	30 [7,9]	30 [7,9]	15 [4,0]
157B9692	PVH/PVHC	Yes	25 [6,6]	50 [13,2]	65 [17,2]	65 [17,2]

Part number for Flow Control Spools for PVML

Part Number	Actuation	PVB with shuttle valve	Flow - l/min [US gal/min]			
			A → T	P → A	P → B	B → T
11145382	PVH/PVHC	Yes	150 [39,6]	110 [29,1]	75 [19,8]	70 [18,5]
11196283	PVH/PVHC	Yes	100 [26,4]	125 [33]	85 [22,5]	70 [18,5]

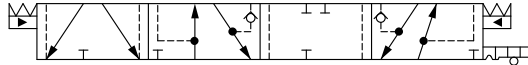
Technical Information
PVG 32 Proportional Valve Group
PVBS Main Spools Part Numbers
Flow Control Spools—Closed Neutral Position with A-float for PVMF
Schematic for PVBS with shuttle valve

Part numbers for Symmetric Flow Control Spools

Part Number	Actuation	PVB with shuttle valve	Flow - l/min [US gal/min]			
			A → T	P → A	P → B	B → T
157B9825	PVE	Yes	5 [1,3]	5 [1,3]	5 [1,3]	5 [1,3]
157B9820	PVE	Yes	10 [2,6]	10 [2,6]	10 [2,6]	10 [2,6]
157B9821	PVE	Yes	25 [6,6]	25 [6,6]	25 [6,6]	25 [6,6]
157B9822	PVE	Yes	40 [10,6]	40 [10,6]	40 [10,6]	40 [10,6]
157B9823	PVE	Yes	65 [17,2]	65 [17,2]	65 [17,2]	65 [17,2]
157B9824 ¹⁾	PVE	Yes	100 [26,4]	100 [26,4]	100 [26,4]	100 [26,4]

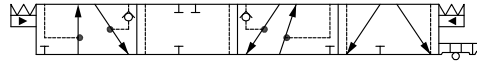
¹⁾ Turbo on A and B port.

Flow Control Spools—Closed Neutral Position with B-float for PVMF
Schematic for PVBS with shuttle valve

Part numbers for Symmetric Flow Control Spools

Part Number	Actuation	PVB with shuttle valve	Flow - l/min [US gal/min]			
			A → T	P → A	P → B	B → T
157B9621	PVE	A-port	25 [6,6]	25 [6,6]	25 [6,6]	25 [6,6]
157B9622	PVE	A-port	40 [10,6]	40 [10,6]	40 [10,6]	40 [10,6]
157B9623	PVE	A-port	65 [17,2]	65 [17,2]	65 [17,2]	65 [17,2]
157B9624 ¹⁾	PVE	A-port	100 [26,4]	100 [26,4]	100 [26,4]	100 [26,4]

¹⁾ Turbo on A and B port

Part numbers for Asymmetric Flow Control Spools

Part Number	Actuation	PVB with shuttle valve	Flow - l/min [US gal/min]			
			A → T	P → A	P → B	B → T
157B9517 ¹⁾	PVE	A-port	100 [26,4]	100 [26,4]	65 [17,2]	65 [17,2]

¹⁾ Turbo on A port

PVBS Main Spools Part Numbers
Flow Control Spools—Closed Neutral Position for PVMR

Schematic for PVBS without shuttle valve

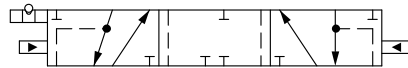

Schematic for PVBS with shuttle valve

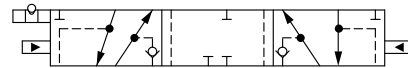

Part numbers for Symmetric Flow Control Spools

Part Number	Actuation	PVB with shuttle valve	Flow – l/min [US gal/min]			
			A → T	P → A	P → B	B → T
157B9705	PVMR	-	5 [1,3]	5 [1,3]	5 [1,3]	5 [1,3]
157B9700	PVMR	-	10 [2,6]	10 [2,6]	10 [2,6]	10 [2,6]
11095634	PVMR	-	15 [4,0]	15 [4,0]	15 [4,0]	15 [4,0]
157B9701	PVMR	-	25 [6,6]	25 [6,6]	25 [6,6]	25 [6,6]
157B9702	PVMR	-	40 [10,6]	40 [10,6]	40 [10,6]	40 [10,6]
157B9703	PVMR	-	65 [17,2]	65 [17,2]	65 [17,2]	65 [17,2]
157B9704	PVMR	-	100 [26,4]	100 [26,4]	100 [26,4]	100 [26,4]
157B9725	PVMR	Yes	5 [1,3]	5 [1,3]	5 [1,3]	5 [1,3]
157B9720	PVMR	Yes	10 [2,6]	10 [2,6]	10 [2,6]	10 [2,6]
157B9721	PVMR	Yes	25 [6,6]	25 [6,6]	25 [6,6]	25 [6,6]
157B9722	PVMR	Yes	40 [10,6]	40 [10,6]	40 [10,6]	40 [10,6]
157B9723	PVMR	Yes	65 [17,2]	65 [17,2]	65 [17,2]	65 [17,2]
157B9724	PVMR	Yes	100 [26,4]	100 [26,4]	100 [26,4]	100 [26,4]

Flow Control Spools—Open/Closed Neutral Position

Schematic for PVBS without shuttle valve

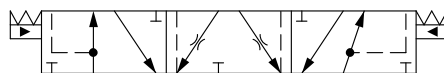

Schematic for PVBS with shuttle valve

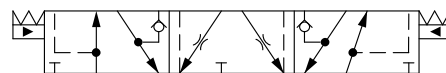

Part numbers for Symmetric Flow Control Spools

Part Number	Actuation	PVB with shuttle valve	Flow – l/min [US gal/min]			
			A → T	P → A	P → B	B → T
11100878	PVE	Yes	35 [9,2]	35 [9,2]	35 [9,2]	35 [9,2]
11027254	PVE	Yes	75 [19,8]	75 [19,8]	75 [19,8]	75 [19,8]
157B9652	PVE	-	25 [6,6]	25 [6,6]	25 [6,6]	25 [6,6]
157B9653	PVE	-	40 [10,6]	40 [10,6]	40 [10,6]	40 [10,6]
157B9654	PVE	-	65 [17,2]	65 [17,2]	65 [17,2]	65 [17,2]
10030501	PVE	Yes	10 [2,6]	10 [2,6]	10 [2,6]	10 [2,6]

Technical Information
PVG 32 Proportional Valve Group
PVBS Main Spools Part Numbers
Part numbers for Asymmetric Flow Control Spools

Part Number	Actuation	PVB with shuttle valve	Flow – l/min [US gal/min]			
			A → T	P → A	P → B	B → T
157B9698	PVE	Yes	15 [4,0]	15 [4,0]	10 [2,6]	10 [2,6]
11055532	PVE	Yes	35 [9,2]	35 [9,2]	65 [17,2]	65 [17,2]
11025812	PVE	Yes	50 [13,2]	50 [13,2]	75 [19,8]	75 [19,8]
11025212	PVE	Yes	18 [4,8]	18 [4,8]	35 [9,2]	35 [9,2]
11025161	PVE	Yes	50 [13,2]	50 [13,2]	25 [6,6]	25 [6,6]
11157400	PVE	Yes	65 [17,2]	65 [17,2]	25 [6,6]	25 [6,6]
11166644*	PVH/PVHC	Yes	50 [13,2]	50 [13,2]	25 [6,6]	25 [6,6]

* Dead band 0.8 mm [0.03 in]

Back pressure Flow Control Spools (A/B->T flow track smaller than P->A/B)

Part Number	Actuation	PVB with shuttle valve	Flow – l/min [US gal/min]			
			A → T	P → A	P → B	B → T
11094317	PVE	Yes	2,5 [0,65]	5 [1,3]	5 [1,3]	2,5 [0,65]
11051992	PVE	Yes	5 [1,3]	18 [4,8]	18 [4,8]	5 [1,3]
11027284	PVE	Yes	6 [1,6]	25 [6,6]	25 [6,6]	6 [1,6]
11117573	PVE	Yes	25 [6,6]	35 [9,2]	65 [17,2]	65 [17,2]
11025212	PVE	Yes	35 [9,2]	35 [9,2]	18 [4,8]	12 [3,2]
11137744	PVE	Yes	35 [9,2]	50 [13,2]	75 [19,8]	75 [19,8]
11027911	PVE	Yes	65 [17,2]	65 [17,2]	35 [9,2]	25 [6,6]
11027922	PVE	Yes	75 [19,8]	75 [19,8]	50 [13,2]	35 [9,2]

Technical Information
PVG 32 Proportional Valve Group
PVBS Main Spools Part Numbers
Flow Control Spools—Throttled Open Neutral Position

Schematic for PVBS without shuttle valve

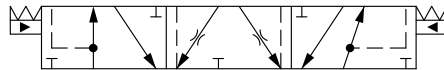

Schematic for PVBS with shuttle valve

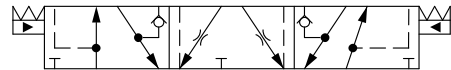

Part numbers for Symmetric Flow Control Spools

Part Number	Actuation	PVB with shuttle valve	Flow – l/min [US gal/min]			
			A → T	P → A	P → B	B → T
157B9697	PVE	-	1 [0,26]	1 [0,26]	1 [0,26]	1 [0,26]
157B7105	PVE	-	5 [1,3]	5 [1,3]	5 [1,3]	5 [1,3]
157B7100	PVE	-	10 [2,6]	10 [2,6]	10 [2,6]	10 [2,6]
157B7101	PVE	-	25 [6,6]	25 [6,6]	25 [6,6]	25 [6,6]
157B9534	PVE	-	25 [6,6]	25 [6,6]	25 [6,6]	40 [6,6]
157B7102	PVE	-	40 [10,6]	40 [10,6]	40 [10,6]	40 [10,6]
157B9537	PVE	-	40 [10,6]	40 [10,6]	40 [10,6]	65 [10,6]
11091340*	PVE	-	1)	40 [10,6]	40 [10,6]	1)
157B9521	PVE	-	1)	40 [10,6]	40 [10,6]	1)
157B9677*	PVE	-	50 [13,2]	50 [13,2]	50 [13,2]	50 [13,2]
157B7103	PVE	-	65 [17,2]	65 [17,2]	65 [17,2]	65 [17,2]
11007176*	PVE	-	1)	65 [17,2]	65 [17,2]	1)
11122809	PVE	-	75 [19,8]	75 [19,8]	75 [19,8]	75 [19,8]
157B7104	PVE	-	100 [26,4]	100 [26,4]	100 [26,4]	100 [26,4]
11144269	PVE	-	100 [26,4]	100 [26,4]	100 [26,4]	1)
157B7106 ³⁾	PVE	-	130 [34,3]	130 [34,3]	130 [34,3]	130 [34,3]
157B9675	PVE	Yes	3 [0,8]	3 [0,8]	3 [0,8]	3 [0,8]
157B7125	PVE	Yes	5 [1,3]	5 [1,3]	5 [1,3]	5 [1,3]
157B7120	PVE	Yes	10 [2,6]	10 [2,6]	10 [2,6]	10 [2,6]
157B9647	PVE	Yes	15 [4,0]	15 [4,0]	15 [4,0]	15 [4,0]
157B9594	PVE	Yes	20 [5,3]	20 [5,3]	20 [5,3]	20 [5,3]
157B7121	PVE	Yes	25 [6,6]	25 [6,6]	25 [6,6]	25 [6,6]
11153790*	PVE	Yes	1)	25 [6,6]	25 [6,6]	1)
157B7122	PVE	Yes	40 [10,6]	40 [10,6]	40 [10,6]	40 [10,6]
157B9538	PVE	Yes	40 [10,6]	40 [10,6]	40 [10,6]	65 [17,2]
11121691	PVE	Yes	65 [17,2]	40 [10,6]	40 [10,6]	40 [10,6]
11108808	PVE	Yes	100 [26,4]	40 [10,6]	40 [10,6]	40 [10,6]
157B9649	PVE	Yes	55 [14,5]	55 [14,5]	55 [14,5]	55 [14,5]
157B7123	PVE	Yes	65 [17,2]	65 [17,2]	65 [17,2]	65 [17,2]
157B9650	PVE	Yes	75 [19,8]	75 [19,8]	75 [19,8]	75 [19,8]
11217660*	PVE	Yes	*	90	90	*
157B7124	PVE	Yes	100 [26,4]	100 [26,4]	100 [26,4]	100 [26,4]
11122118*	PVE	Yes	1)	100 [26,4]	100 [26,4]	1)

Technical Information
PVG 32 Proportional Valve Group
PVBS Main Spools Part Numbers
Part numbers for Symmetric Flow Control Spools (continued)

Part Number	Actuation	PVB with shuttle valve	Flow – l/min [US gal/min]			
			A → T	P → A	P → B	B → T
157B7126 ³⁾	PVE	Yes	130 [34,3]	130 [34,3]	130 [34,3]	130 [34,3]
157B9854 ³⁾	PVE	Yes	130 [34,3]	130 [34,3]	130 [34,3]	¹⁾
157B9105	PVH/PVHC	-	5 [1,3]	5 [1,3]	5 [1,3]	5 [1,3]
157B9100	PVH/PVHC	-	10 [2,6]	10 [2,6]	10 [2,6]	10 [2,6]
157B9101	PVH/PVHC	-	25 [6,6]	25 [6,6]	25 [6,6]	25 [6,6]
157B9102	PVH/PVHC	-	40 [10,6]	40 [10,6]	40 [10,6]	40 [10,6]
157B9103	PVH/PVHC	-	65 [17,2]	65 [17,2]	65 [17,2]	65 [17,2]
157B9104	PVH/PVHC	-	100 [26,4]	100 [26,4]	100 [26,4]	100 [26,4]
157B9106 ³⁾	PVH/PVHC	-	130 [34,3]	130 [34,3]	130 [34,3]	130 [34,3]
157B9125	PVH/PVHC	Yes	5 [1,3]	5 [1,3]	5 [1,3]	5 [1,3]
157B9120	PVH/PVHC	Yes	10 [2,6]	10 [2,6]	10 [2,6]	10 [2,6]
157B9121	PVH/PVHC	Yes	25 [6,6]	25 [6,6]	25 [6,6]	25 [6,6]
157B9122	PVH/PVHC	Yes	40 [10,6]	40 [10,6]	40 [10,6]	40 [10,6]
157B9123	PVH/PVHC	Yes	65 [17,2]	65 [17,2]	65 [17,2]	65 [17,2]
157B9124	PVH/PVHC	Yes	100 [26,4]	100 [26,4]	100 [26,4]	100 [26,4]
157B9126 ³⁾	PVH/PVHC	Yes	130 [34,3]	130 [34,3]	130 [34,3]	130 [34,3]

* Fully open in neutral

¹⁾ Fully opened, no flow restriction notch

³⁾ Turbo on A and B port

Part numbers for Asymmetric Flow Control Spools

Part Number	Actuation	PVB with shuttle valve	Flow – l/min [US gal/min]			
			A → T	P → A	P → B	B → T
11004389	PVE	-	5 [1,3]	5 [1,3]	65 [17,2]	65 [17,2]
157B9094	PVE	-	15 [4,0]	15 [4,0]	30 [7,9]	30 [7,9]
11217665	PVE	-	25 [6,6]	25 [6,6]	100 [26,4]	100 [26,4]
157B9815	PVE	-	30 [7,9]	30 [7,9]	20 [5,3]	20 [5,3]
11093116	PVE	-	40 [10,6]	40 [10,6]	20 [5,3]	20 [5,3]
11005204	PVE	-	40 [10,6]	40 [10,6]	65 [17,2]	65 [17,2]
157B9595	PVE	-	40 [10,6]	40 [10,6]	100 [26,4]	100 [26,4]
157B9860	PVE	-	50 [13,2]	50 [13,2]	20 [5,3]	20 [5,3]
11091575	PVE	-	55 [14,5]	55 [14,5]	30 [7,9]	30 [7,9]
157B9696	PVE	-	65 [17,2]	65 [17,2]	10 [2,6]	10 [2,6]
157B9506	PVE	-	65 [17,2]	65 [17,2]	40 [10,6]	40 [10,6]
157B9586	PVE	-	65 [17,2]	65 [17,2]	100 [26,4]	100 [26,4]
11137895*	PVE	-	*	65 [17,2]	40 [10,6]	*
11122941	PVE	Yes	15 [4,0]	15 [4,0]	100 [26,4]	100 [26,4]
157B9830	PVE	Yes	25 [6,6]	25 [6,6]	40 [10,6]	40 [10,6]

PVBS Main Spools Part Numbers
Part numbers for Asymmetric Flow Control Spools (continued)

Part Number	Actuation	PVB with shuttle valve	Flow – l/min [US gal/min]			
			A → T	P → A	P → B	B → T
157B9558	PVE	Yes	30 [7,9]	30 [7,9]	10 [2,6]	10 [2,6]
157B9833	PVE	Yes	30 [7,9]	30 [7,9]	20 [5,3]	20 [5,3]
157B9813	PVE	Yes	30 [7,9]	30 [7,9]	55 [14,5]	55 [14,5]
11100875*	PVE	Yes	*	35 [9,2]	18 [4,8]	*
11100881*	PVE	Yes	*	35 [9,2]	50 [13,2]	*
157B9567	PVE	Yes	40 [10,6]	40 [10,6]	20 [5,3]	20 [5,3]
157B9865	PVE	Yes	40 [10,6]	40 [10,6]	25 [6,6]	25 [6,6]
11125125	PVE	Yes	40 [10,6]	40 [10,6]	65 [17,2]	65 [17,2]
157B9505	PVE	Yes	40 [10,6]	40 [10,6]	100 [26,4]	100 [26,4]
11096423	PVE	Yes	50 [13,2]	50 [13,2]	65 [17,2]	65 [17,2]
157B9681	PVE	Yes	55 [14,5]	55 [14,5]	30 [7,9]	30 [7,9]
157B9814	PVE	Yes	65 [17,2]	65 [17,2]	40 [10,6]	40 [10,6]
11217660*	PVE	Yes	*	80 [21,1]	80 [21,1]	*
11202615	PVH/PVHC	-	25 [6,6]	25 [6,6]	25 [6,6]	40 [10,6]
157B9847	PVH/PVHC	-	30 [7,9]	30 [7,9]	20 [5,3]	20 [5,3]
157B9546	PVH/PVHC	-	40 [10,6]	25 [6,6]	20 [5,3]	40 [10,6]
157B9686	PVH/PVHC	-	40 [10,6]	30 [7,9]	25 [6,6]	40 [10,6]
157B9685	PVH/PVHC	-	40 [10,6]	40 [10,6]	35 [9,2]	40 [10,6]
157B9498	PVH/PVHC	-	65 [17,2]	65 [17,2]	40 [10,6]	40 [10,6]
11140120*	PVH/PVHC	-	*	65 [17,2]	65 [17,2]	*
11165855	PVH/PVHC	Yes	5 [1,3]	5 [1,3]	3 [0,8]	3 [0,8]
11165919	PVH/PVHC	Yes	20 [5,3]	20 [5,3]	15 [4]	15 [4]
11272759	PVH/PVHC	Yes	25 [6,6]	25 [6,6]	10 [2,6]	10 [2,6]
11235870	PVH/PVHC	Yes	25 [6,6]	25 [6,6]	15 [4]	15 [4]
11200936	PVH/PVHC	Yes	40 [10,6]	40 [10,6]	25 [6,6]	25 [6,6]
11092123	PVH/PVHC	Yes	40 [10,6]	40 [10,6]	100 [26,4]	100 [26,4]
11200922	PVH/PVHC	Yes	65 [17,2]	65 [17,2]	40 [10,6]	40 [10,6]
11153474	PVH/PVHC	Yes	80 [21,1]	80 [21,1]	65 [17,2]	65 [17,2]

* Fully opened, no flow restriction notch

Back pressure Flow Control Spools (A/B->T flow track smaller than P->A/B)

Part Number	Actuation	PVB with shuttle valve	Flow – l/min [US gal/min]			
			A → T	P → A	P → B	B → T
11074918	PVE	-	5 [1,3]	10 [2,6]	5 [1,3]	10 [2,6]
11006879	PVE	-	25 [6,6]	25 [6,6]	65 [17,2]	25 [6,6]
11097891	PVE	Yes	40 [10,6]	100 [26,4]	40 [10,6]	40 [10,6]

Technical Information
PVG 32 Proportional Valve Group

PVBS Main Spools Part Numbers

Flow Control Spools for PVML

Part Number	Actuation	PVB with shuttle valve	Flow – l/min [US gal/min]			
			A → T	P → A	P → B	B → T
157B9803	PVE	-	65 [17,2]	65 [17,2]	65 [17,2]	65 [17,2]
11122774	PVE	-	90 [23,8]	90 [23,8]	90 [23,8]	90 [23,8]
157B9802	PVE	-	100 [26,4]	100 [26,4]	100 [26,4]	100 [26,4]

PVBS Main Spools Part Numbers
Flow Control Spools—Throttled Open Neutral Position for PVMR

Schematic for PVBS without shuttle valve

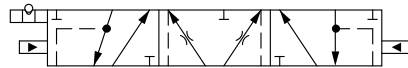

Schematic for PVBS with shuttle valve

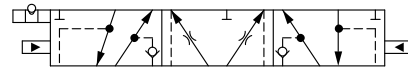

Part numbers for Symmetric Flow Control Spools

Part Number	Actuation	PVB with shuttle valve	Flow – l/min [US gal/min]			
			A → T	P → A	P → B	B → T
157B9715	PVMR	-	5 [1,3]	5 [1,3]	5 [1,3]	5 [1,3]
157B9710	PVMR	-	10 [2,6]	10 [2,6]	10 [2,6]	10 [2,6]
157B9711	PVMR	-	25 [6,6]	25 [6,6]	25 [6,6]	25 [6,6]
157B9712	PVMR	-	40 [10,6]	40 [10,6]	40 [10,6]	40 [10,6]
157B9678	PVMR	-	50 [13,2]	50 [13,2]	50 [13,2]	50 [13,2]
157B9713	PVMR	-	65 [17,2]	65 [17,2]	65 [17,2]	65 [17,2]
11128430	PVMR	-	80 [21,1]	80 [21,1]	80 [21,1]	80 [21,1]
157B9714	PVMR	-	100 [26,4]	100 [26,4]	100 [26,4]	100 [26,4]
157B9716 ¹⁾	PVMR	-	130 [34,3]	130 [34,3]	130 [34,3]	130 [34,3]
157B9735	PVMR	Yes	5 [1,3]	5 [1,3]	5 [1,3]	5 [1,3]
157B9730	PVMR	Yes	10 [2,6]	10 [2,6]	10 [2,6]	10 [2,6]
157B9731	PVMR	Yes	25 [6,6]	25 [6,6]	25 [6,6]	25 [6,6]
157B9732	PVMR	Yes	40 [10,6]	40 [10,6]	40 [10,6]	40 [10,6]
157B9733	PVMR	Yes	65 [17,2]	65 [17,2]	65 [17,2]	65 [17,2]
157B9734	PVMR	Yes	100 [26,4]	100 [26,4]	100 [26,4]	100 [26,4]

¹⁾ Turbo on A and B port

Part numbers for Asymmetric Flow Control Spools

Part Number	Actuation	PVB with shuttle valve	Flow – l/min [US gal/min]			
			A → T	P → A	P → B	B → T
11107125	PVMR	-	5 [1,3]	5 [1,3]	65 [17,2]	65 [17,2]
11119504	PVMR	-	40 [10,6]	40 [10,6]	65 [17,2]	65 [17,2]
11071543	PVMR	Yes	30 [7,9]	30 [7,9]	10 [2,6]	10 [2,6]

Technical Information
PVG 32 Proportional Valve Group
PVBS Main Spools Part Numbers
Flow Control Spools—Throttled A to T Neutral Position

Schematic for PVBS without shuttle valve

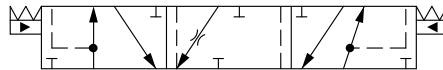

Schematic for PVBS with shuttle valve

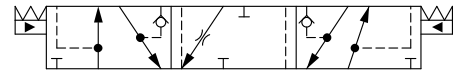

Part numbers for Symmetric Flow Control Spools

Part Number	Actuation	PVB with shuttle valve	Flow – l/min [US gal/min]			
			A → T	P → A	P → B	B → T
157B9504	PVE	-	15 [4,0]	15 [4,0]	15 [4,0]	15 [4,0]
157B7401	PVE	-	25 [6,6]	25 [6,6]	25 [6,6]	25 [6,6]
157B7402	PVE	-	40 [10,6]	40 [10,6]	40 [10,6]	40 [10,6]
157B7403	PVE	-	65 [17,2]	65 [17,2]	65 [17,2]	65 [17,2]
157B7404	PVE	-	100 [26,4]	100 [26,4]	100 [26,4]	100 [26,4]
157B7406 ¹⁾	PVE	-	130 [34,3]	130 [34,3]	130 [34,3]	130 [34,3]
157B9846	PVE	-	²⁾	130 [34,3]	130 [34,3]	130 [34,3]
157B9527	PVE	Yes	15 [4,0]	15 [4,0]	15 [4,0]	15 [4,0]
157B7421	PVE	Yes	25 [6,6]	25 [6,6]	25 [6,6]	25 [6,6]
157B7422	PVE	Yes	40 [10,6]	40 [10,6]	40 [10,6]	40 [10,6]
157B7423	PVE	Yes	65 [17,2]	65 [17,2]	65 [17,2]	65 [17,2]
157B7424	PVE	Yes	100 [26,4]	100 [26,4]	100 [26,4]	100 [26,4]
157B9085	PVH/PVHC	-	100 [26,4]	100 [26,4]	100 [26,4]	100 [26,4]
11150180	PVH/PVHC	Yes	100 [26,4]	100 [26,4]	100 [26,4]	100 [26,4]

¹⁾ Turbo on A and B port.

²⁾ Fully opened, no flow restriction notch.

Part numbers for Asymmetric Flow Control Spools

Part Number	Actuation	PVB with shuttle valve	Flow – l/min [US gal/min]			
			A → T	P → A	P → B	B → T
11022518	PVE	Yes	25 [6,6]	25 [6,6]	40 [10,6]	40 [10,6]
157B9834	PVE	Yes	30 [7,9]	30 [7,9]	20 [5,3]	20 [5,3]
11202228	PVE	-	100 [26,4]	100 [26,4]	50 [13,2]	100 [26,4]
11201797	PVE	Yes	150 [39,6]	150 [39,6]	100 [26,4]	100 [26,4]

Technical Information
PVG 32 Proportional Valve Group
PVBS Main Spools Part Numbers
Flow Control Spools—Throttled B to T Neutral Position

Schematic for PVBS without shuttle valve

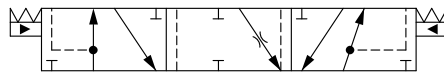

Schematic for PVBS with shuttle valve

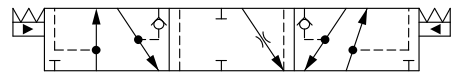

Part numbers for Symmetric Flow Control Spools

Part Number	Actuation	PVB with shuttle valve	Flow – l/min [US gal/min]			
			A → T	P → A	P → B	B → T
157B7500	PVE	-	10 [2,6]	10 [2,6]	10 [2,6]	10 [2,6]
157B7501	PVE	-	25 [6,6]	25 [6,6]	25 [6,6]	25 [6,6]
157B7502	PVE	-	40 [10,6]	40 [10,6]	40 [10,6]	40 [10,6]
157B7503	PVE	-	65 [17,2]	65 [17,2]	65 [17,2]	65 [17,2]
157B7504	PVE	-	100 [26,4]	100 [26,4]	100 [26,4]	100 [26,4]
157B7520	PVE	Yes	10 [2,6]	10 [2,6]	10 [2,6]	10 [2,6]
157B7521	PVE	Yes	25 [6,6]	25 [6,6]	25 [6,6]	25 [6,6]
157B7522	PVE	Yes	40 [10,6]	40 [10,6]	40 [10,6]	40 [10,6]
157B7523	PVE	Yes	65 [17,2]	65 [17,2]	65 [17,2]	65 [17,2]
157B7524	PVE	Yes	100 [26,4]	100 [26,4]	100 [26,4]	100 [26,4]
11202731	PVH/PVHC	Yes	25 [6,6]	25 [6,6]	25 [6,6]	25 [6,6]
11238938	PVH/PVHC	Yes	40 [10,6]	40 [10,6]	40 [10,6]	40 [10,6]
11305187	PVH/PVHC	Yes	65 [17,2]	65 [17,2]	65 [17,2]	65 [17,2]
11168334	PVH/PVHC	Yes	75 [19,8]	75 [19,8]	75 [19,8]	75 [19,8]

Part numbers for Asymmetric Flow Control Spools

Part Number	Actuation	PVB with shuttle valve	Flow – l/min [US gal/min]			
			A → T	P → A	P → B	B → T
157B9948	PVE	Yes	25 [6,6]	25 [6,6]	10 [2,6]	10 [2,6]
11008038	PVE	Yes	40 [10,6]	40 [10,6]	25 [6,6]	25 [6,6]
11037198	PVE	Yes	100 [26,4]	40 [10,6]	40 [10,6]	40 [10,6]
11126490	PVE	Yes	65 [17,2]	65 [17,2]	40 [10,6]	40 [10,6]

Part numbers for Full open B → T

Part Number	Actuation	PVB with shuttle valve	Flow – l/min [US gal/min]			
			A → T	P → A	P → B	B → T
11131447	PVE	-	10 [2,6]	10 [2,6]	10 [2,6]	10 [2,6]

Technical Information
PVG 32 Proportional Valve Group

PVBS Main Spools Part Numbers

Flow Control Spools—Closed A and Open/Closed B Position

Part numbers for Asymmetric Flow Control Spools

Part Number	Actuation	PVB with shuttle valve	Flow – l/min [US gal/min]			
			A → T	P → A	P → B	B → T
157B9698	PVE	Yes	15 [4,0]	15 [4,0]	10 [2,6]	10 [2,6]

Flow Control Spools—Open A and Open/Closed B Position

Part numbers for Asymmetric Flow Control Spools

Part Number	Actuation	PVB with shuttle valve	Flow – l/min [US gal/min]			
			A → T	P → A	P → B	B → T
157B9194	PVE	-	65 [17,2]	65 [17,2]	65 [17,2]	65 [17,2]

PVBS Main Spools Part Numbers
Linear Flow Control Spools—Closed Neutral Position

Schematic for PVBS without shuttle valve

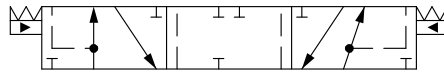

Schematic for PVBS with shuttle valve

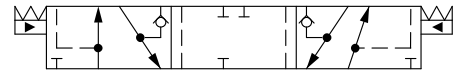

Part numbers for Symmetric Flow Control Spools

Part Number	Actuation	PVB with Shuttle Valve	Flow – l/min [US gal/min]			
			A → T	P → A	P → B	B → T
157B9750	PVE	-	10 [2,6]	10 [2,6]	10 [2,6]	10 [2,6]
157B9751	PVE	-	25 [6,6]	25 [6,6]	25 [6,6]	25 [6,6]
157B9752	PVE	-	40 [10,6]	40 [10,6]	40 [10,6]	40 [10,6]
157B9753	PVE	-	65 [17,2]	65 [17,2]	65 [17,2]	65 [17,2]
157B9754	PVE	-	100 [26,4]	100 [26,4]	100 [26,4]	100 [26,4]
157B9770	PVE	Yes	10 [2,6]	10 [2,6]	10 [2,6]	10 [2,6]
157B9771	PVE	Yes	25 [6,6]	25 [6,6]	25 [6,6]	25 [6,6]
157B9772	PVE	Yes	40 [10,6]	40 [10,6]	40 [10,6]	40 [10,6]
157B9773	PVE	Yes	65 [17,2]	65 [17,2]	65 [17,2]	65 [17,2]
157B9655	PVE	Yes	85 [22,5]	85 [22,5]	85 [22,5]	85 [22,5]
157B9774	PVE	Yes	100 [26,4]	100 [26,4]	100 [26,4]	100 [26,4]
11198094	PVH/PVHC	-	25 [6,6]	25 [6,6]	25 [6,6]	25 [6,6]
11239803	PVH/PVHC	-	65 [17,2]	65 [17,2]	65 [17,2]	65 [17,2]
11051903	PVH/PVHC	-	100 [26,4]	100 [26,4]	100 [26,4]	100 [26,4]
11234468	PVH/PVHC	-	130 [34,3]	130 [34,3]	130 [34,3]	130 [34,3]
11107159	PVH/PVHC	Yes	10 [2,6]	10 [2,6]	10 [2,6]	10 [2,6]
11107222	PVH/PVHC	Yes	40 [10,6]	40 [10,6]	40 [10,6]	40 [10,6]
157B9080	PVH/PVHC	Yes	65 [17,2]	65 [17,2]	65 [17,2]	65 [17,2]
11234474	PVH/PVHC	Yes	100 [26,4]	100 [26,4]	100 [26,4]	100 [26,4]
11286861	PVH/PVHC	Yes	120 [31,7]	120 [31,7]	120 [31,7]	120 [31,7]

Part numbers for Asymmetric Flow Control Spools

Part Number	Actuation	PVB with Shuttle Valve	Flow – l/min [US gal/min]			
			A → T	P → A	P → B	B → T
157B9578	PVE	-	15 [4]	15 [4]	25 [6,6]	25 [6,6]
11020734	PVE	-	¹⁾	65 [17,2]	40 [10,6]	¹⁾
11059283	PVE	-	85 [22,5]	85 [22,5]	65 [17,2]	65 [17,2]
11192746	PVE	Yes	3 [0,8]	3 [0,8]	10 [2,6]	10 [2,6]

¹⁾ Fully opened, no flow restriction notch

All spools are with Dead band 0.8 mm [0.03 in].

Technical Information
PVG 32 Proportional Valve Group
PVBS Main Spools Part Numbers

Part number for Back pressure Flow Control Spools (A/B->T flow track smaller than P->A/B)

Part Number	Actuation	PVB with Shuttle Valve	Flow - l/min [US gal/min]			
			A → T	P → A	P → B	B → T
157B9838	PVE	-	15 [4]	50 [13,2]	65 [17,2]	50 [13,2]
157B9914	PVE	-	25 [6,6]	65 [17,2]	100 [26,4]	50 [13,2]
11158758	PVE	Yes	15 [4]	40 [10,6]	65 [17,2]	15 [4]
11151485	PVE	Yes	30 [7,9]	85 [22,5]	110 [29,1]	35 [9,2]
11158757	PVE	Yes	20 [5,3]	85 [22,5]	110 [29,1]	40 [10,6]

All spools are with Dead band 0.8 mm [0.03 in].

Part numbers for Flow Control Spools for PVML

Part Number	Actuation	PVB with Shuttle Valve	Flow - l/min [US gal/min]			
			A → T	P → A	P → B	B → T
157B9680	PVML	-	100 [26,4]	100 [26,4]	100 [26,4]	100 [26,4]
157B9587	PVML	-	130 [34,3]	130 [34,3]	130 [34,3]	130 [34,3]

PVBS Main Spools Part Numbers
Linear Flow Control Spools—Throttled Open Neutral Position

Schematic for PVBS without shuttle valve

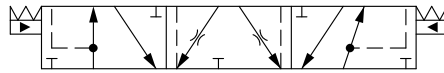

Schematic for PVBS with shuttle valve

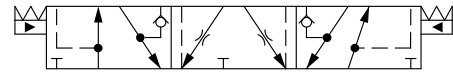

Part numbers for Symmetric Flow Control Spools

Part Number	Actuation	PVB with Shuttle Valve	Flow – l/min [US gal/min]			
			A → T	P → A	P → B	B → T
11147577	PVE	-	5 [1,3]	5 [1,3]	5 [1,3]	5 [1,3]
157B9760	PVE	-	10 [2,6]	10 [2,6]	10 [2,6]	10 [2,6]
157B9761	PVE	-	25 [6,6]	25 [6,6]	25 [6,6]	25 [6,6]
157B9762	PVE	-	40 [10,6]	40 [10,6]	40 [10,6]	40 [10,6]
11122703	PVE	-	55 [14,5]	55 [14,5]	55 [14,5]	55 [14,5]
157B9763	PVE	-	65 [17,2]	65 [17,2]	65 [17,2]	65 [17,2]
11143980	PVE	-	85 [22,5]	85 [22,5]	85 [22,5]	85 [22,5]
157B9764	PVE	-	100 [26,4]	100 [26,4]	100 [26,4]	100 [26,4]
157B9099	PVE	-	120 [31,7]	120 [31,7]	120 [31,7]	120 [31,7]
157B9098	PVE	-	130 [34,3]	130 [34,3]	130 [34,3]	130 [34,3]
11140460	PVE	Yes	5 [1,3]	5 [1,3]	5 [1,3]	5 [1,3]
157B9780	PVE	Yes	10 [2,6]	10 [2,6]	10 [2,6]	10 [2,6]
157B9781	PVE	Yes	25 [6,6]	25 [6,6]	25 [6,6]	25 [6,6]
157B9782	PVE	Yes	40 [10,6]	40 [10,6]	40 [10,6]	40 [10,6]
11076654	PVE	Yes	50 [13,2]	50 [13,2]	50 [13,2]	50 [13,2]
157B9783	PVE	Yes	65 [17,2]	65 [17,2]	65 [17,2]	65 [17,2]
11161786	PVE	Yes	80 [21,1]	80 [21,1]	80 [21,1]	80 [21,1]
157B9784	PVE	Yes	100 [26,4]	100 [26,4]	100 [26,4]	100 [26,4]
11142634	PVE	Yes	130 [34,3]	130 [34,3]	130 [34,3]	130 [34,3]
11173684*	PVE	Yes	130 [34,3]	130 [34,3]	130 [34,3]	130 [34,3]
157B9807	PVH/PVHC	-	10 [2,6]	10 [2,6]	10 [2,6]	10 [2,6]
157B9805	PVH/PVHC	-	25 [6,6]	25 [6,6]	25 [6,6]	25 [6,6]
11046738	PVH/PVHC	-	40 [10,6]	40 [10,6]	40 [10,6]	40 [10,6]
11080984	PVH/PVHC	-	65 [17,2]	65 [17,2]	65 [17,2]	65 [17,2]
11193615	PVH/PVHC	-	100 [26,4]	100 [26,4]	100 [26,4]	100 [26,4]
11218248	PVH/PVHC	-	130 [34,3]	130 [34,3]	130 [34,3]	130 [34,3]
11271715	PVH/PVHC	Yes	10 [2,6]	10 [2,6]	10 [2,6]	10 [2,6]
157B9806	PVH/PVHC	Yes	25 [6,6]	25 [6,6]	25 [6,6]	25 [6,6]
157B9079	PVH/PVHC	Yes	40 [10,6]	40 [10,6]	40 [10,6]	40 [10,6]
157B9081	PVH/PVHC	Yes	65 [17,2]	65 [17,2]	65 [17,2]	65 [17,2]
157B9082	PVH/PVHC	Yes	100 [26,4]	100 [26,4]	100 [26,4]	100 [26,4]

* Turbo on A and B port

All spools are with Dead band 0.8 mm [0.03 in].

Technical Information
PVG 32 Proportional Valve Group
PVBS Main Spools Part Numbers
Part numbers for Asymmetric Flow Control Spools

Part Number	Actuation	PVB with Shuttle Valve	Flow – l/min [US gal/min]			
			A → T	P → A	P → B	B → T
11165600 ¹	PVE	-	12.5 [3,3]	50 [13,2]	65 [17,2]	50 [17,2]
157B9665	PVE	-	65 [17,2]	65 [17,2]	25 [6,6]	25 [6,6]
11106532 ¹	PVE	-	65 [17,2]	65 [17,2]	50 [13,2]	25 [6,6]
11177401	PVE	-	100 [26,4]	100 [26,4]	40 [10,6]	40 [10,6]
11235005	PVE	Yes	20 [5,3]	20 [5,3]	15 [4]	15 [4]
11235064	PVE	Yes	50 [13,2]	50 [13,2]	25 [6,6]	25 [6,6]
11189466 ¹	PVE	Yes	100 [26,4]	100 [26,4]	40 [10,6]	40 [10,6]
11168699	PVH/PVHC	-	25 [6,6]	25 [6,6]	10 [2,6]	10 [2,6]
11168692	PVH/PVHC	-	50 [13,2]	50 [13,2]	30 [7,9]	30 [7,9]
11167604	PVH/PVHC	Yes	5 [1,3]	5 [1,3]	3 [0,8]	3 [0,8]
11272764	PVH/PVHC	Yes	10 [2,6]	10 [2,6]	65 [17,2]	65 [17,2]
11167338	PVH/PVHC	Yes	20 [5,3]	20 [5,3]	15 [4]	15 [4]

¹ Dead band 1.5 mm [0.06 in].

All spools are with Dead band 0.8 mm [0.03 in].

Flow Control Spools for PVML

Part Number	Actuation	PVB with Shuttle Valve	Flow – l/min [US gal/min]			
			A → T	P → A	P → B	B → T
11136831	PVE	-	25 [6,6]	25 [6,6]	25 [6,6]	25 [6,6]
11136827	PVE	-	40 [10,6]	40 [10,6]	40 [10,6]	40 [10,6]
11141375	PVE	Yes	25 [6,6]	25 [6,6]	25 [6,6]	25 [6,6]
11142973	PVH/PVHC	-	100 [26,4]	100 [26,4]	100 [26,4]	100 [26,4]

All spools are with Dead band 0.8 mm [0.03 in].

Linear Flow Control Spools—Throttled A to T Neutral Position
Part numbers for Symmetric Flow Control Spools

Part Number	Actuation	PVB with shuttle valve	Flow – l/min [US gal/min]			
			A → T	P → A	P → B	B → T
157B9794	PVE	-	100 [26,4]	100 [26,4]	100 [26,4]	100 [26,4]

Linear Flow Control Spools—Throttled B to T Neutral Position
Part numbers for Symmetric Flow Control Spools

Part Number	Actuation	PVB with shuttle valve	Flow – l/min [US gal/min]			
			A → T	P → A	P → B	B → T
157B9804	PVE	-	100 [26,4]	100 [26,4]	100 [26,4]	100 [26,4]

Technical Information
PVG 32 Proportional Valve Group
PVBS Main Spools Part Numbers
Linear Flow Control Spools—Open/Closed Neutral Position

Schematic for PVBS without shuttle valve

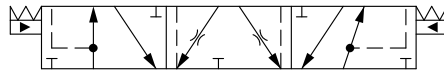

Schematic for PVBS with shuttle valve

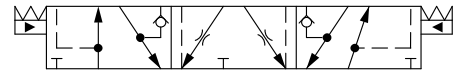

Part numbers for Back pressure Flow Control Spools (A/B->T flow track smaller than P->A/B)

Part Number	Actuation	PVB with Shuttle Valve	Flow – l/min [US gal/min]			
			A → T	P → A	P → B	B → T
11181495 ¹	PVE	Yes	17.5 [4,6]	40 [10,6]	40 [10,6]	17.5 [4,6]
11146797	PVE	Yes	15 [4]	65 [17,2]	40 [10,6]	10 [2,6]
11166644	PVH/PVHC	Yes	50 [13,2]	50 [13,2]	25 [6,6]	25 [6,6]

¹ Dead band 1.5 mm [0.06 in].

All spools are with Dead band 0.8 mm [0.03 in].

Linear Flow Control Spools—Throttled Open Position for PVMR

Part numbers for Symmetric Flow Control Spools

Part Number	Actuation	PVB with shuttle valve	Flow – l/min [US gal/min]			
			A → T	P → A	P → B	B → T
11231448	PVMR	-	40 [10,6]	40 [10,6]	40 [10,6]	40 [10,6]
157B9196	PVMR	-	65 [17,2]	65 [17,2]	65 [17,2]	65 [17,2]
11231449	PVMR	-	100 [26,4]	100 [26,4]	100 [26,4]	100 [26,4]

Single Acting Cylinder Flow Control Spools—Neutral A-port Position

Schematic for PVBS without shuttle valve

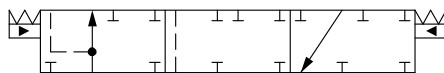

Symmetric flow control spools

Part Number	Actuation	PVB with shuttle valve	Flow – l/min [US gal/min]			
			A → T	P → A	P → B	B → T
11077423	PVE	-	5 [1,3]	5 [1,3]	-	-
157B7200	PVE	-	10 [2,6]	10 [2,6]	-	-
157B7201	PVE	-	25 [6,6]	25 [6,6]	-	-
157B7202	PVE	-	40 [10,6]	40 [10,6]	-	-
157B7203	PVE	-	65 [17,2]	65 [17,2]	-	-
157B7204	PVE	-	100 [26,4]	100 [26,4]	-	-
11015830	PVE	-	130 [34,3]	130 [34,3]	-	-
157B9200	PVH/PVHC	-	10 [2,6]	10 [2,6]	-	-
157B9201	PVH/PVHC	-	25 [6,6]	25 [6,6]	-	-
157B9202	PVH/PVHC	-	40 [10,6]	40 [10,6]	-	-

Technical Information
PVG 32 Proportional Valve Group

PVBS Main Spools Part Numbers
Symmetric flow control spools (continued)

Part Number	Actuation	PVB with shuttle valve	Flow – l/min [US gal/min]			
			A → T	P → A	P → B	B → T
157B9203	PVH/PVHC	-	65 [17,2]	65 [17,2]	-	-
157B9204	PVH/PVHC	-	100 [26,4]	100 [26,4]	-	-
11085447	PVH/PVHC	-	130 [34,3]	130 [34,3]	-	-

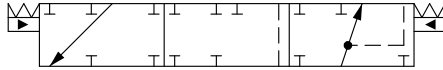
Technical Information
PVG 32 Proportional Valve Group
PVBS Main Spools Part Numbers
Single Acting Cylinder Flow Control Spools—Neutral B-port Position
Schematic for PVBS without shuttle valve

Symmetric flow control spools

Part Number	Actuation	PVB with shuttle valve	Flow – l/min [US gal/min]			
			A → T	P → A	P → B	B → T
157B7300	PVE	-	-	-	10 [2,6]	10 [2,6]
157B7301	PVE	-	-	-	25 [6,6]	25 [6,6]
157B7302	PVE	-	-	-	40 [10,6]	40 [10,6]
157B7303	PVE	-	-	-	65 [17,2]	65 [17,2]
157B7304	PVE	-	-	-	100 [26,4]	100 [26,4]
157B9301	PVH/PVHC	-	-	-	25 [6,6]	25 [6,6]

Back pressure Flow Control Spool (A/B->T flow track smaller than P->A/B)

Part Number	Actuation	PVB with shuttle valve	Flow – l/min [US gal/min]			
			A → T	P → A	P → B	B → T
11098878	PVE	-	-	-	25 [6,6]	5 [1,3]
11104486	PVH/PVHC	-	-	-	25 [6,6]	5 [1,3]

Single Acting Cylinder Linear Flow Control Spools—Closed Neutral A-port Position
Part numbers for Symmetric Flow Control Spools

Part Number	Actuation	PVB with shuttle valve	Flow – l/min [US gal/min]			
			A → T	P → A	P → B	B → T
157B9588	PVE	-	100 [26,4]	100 [26,4]	-	-

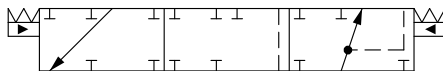
Single Acting Cylinder Linear Flow Control Spools—Neutral B-port Position
Schematic for PVBS without shuttle valve

Back pressure Flow Control Spool (A/B->T flow track smaller than P->A/B)

Part Number	Actuation	PVB with shuttle valve	Flow – l/min [US gal/min]			
			A → T	P → A	P → B	B → T
157B9662	PVE	-	-	-	5 [1,3]	5 [1,3]

Technical Information
PVG 32 Proportional Valve Group
PVBS Main Spools Part Numbers
Flow/Pressure Control Spools—Closed Neutral Position

All spools have flow control on port A, pressure control on port B and a dead band on 1,5 mm [0,06 in].

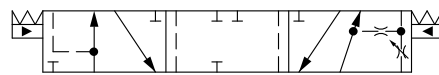
Schematic for PVBS without shuttle valve



Schematic for PVBS with shuttle valve

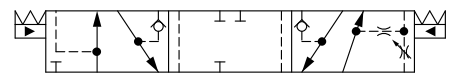

Part numbers for Symmetric FC/PC Spools

Part Number	Actuation	PVB with shuttle valve	Flow – l/min [US gal/min]			
			A → T	P → A	P → B	B → T
157B7050	PVE	-	10 [2,6]	10 [2,6]	10 [2,6]	10 [2,6]
157B7051	PVE	-	25 [6,6]	25 [6,6]	25 [6,6]	25 [6,6]
157B7052	PVE	-	40 [10,6]	40 [10,6]	40 [10,6]	40 [10,6]
157B7053	PVE	-	65 [17,2]	65 [17,2]	65 [17,2]	65 [17,2]
157B7054	PVE	-	100 [26,4]	100 [26,4]	100 [26,4]	100 [26,4]
11241131	PVE	Yes	10 [2,6]	10 [2,6]	10 [2,6]	10 [2,6]
157B7071	PVE	Yes	25 [6,6]	25 [6,6]	25 [6,6]	25 [6,6]
157B7072	PVE	Yes	40 [10,6]	40 [10,6]	40 [10,6]	40 [10,6]
157B7073	PVE	Yes	65 [17,2]	65 [17,2]	65 [17,2]	65 [17,2]
157B7074	PVE	Yes	100 [26,4]	100 [26,4]	100 [26,4]	100 [26,4]
157B9052	PVH/PVHC	-	40 [10,6]	40 [10,6]	40 [10,6]	40 [10,6]
157B9053	PVH/PVHC	-	65 [17,2]	65 [17,2]	65 [17,2]	65 [17,2]
157B9054	PVH/PVHC	-	100 [26,4]	100 [26,4]	100 [26,4]	100 [26,4]
157B9072	PVH/PVHC	Yes	40 [10,6]	40 [10,6]	40 [10,6]	40 [10,6]
157B9073	PVH/PVHC	Yes	65 [17,2]	65 [17,2]	65 [17,2]	65 [17,2]
157B9074	PVH/PVHC	Yes	100 [26,4]	100 [26,4]	100 [26,4]	100 [26,4]

Part numbers for Asymmetric FC/PC Spools

Part Number	Actuation	PVB with shuttle valve	Flow – l/min [US gal/min]			
			A → T	P → A	P → B	B → T
157B9529	PVE	Yes	65 [17,2]	65 [17,2]	40 [10,6]	65 [17,2]

Back pressure FC/PC Spools (A/B->T flow track smaller than P->A/B)

Part Number	Actuation	PVB with shuttle valve	Flow – l/min [US gal/min]			
			A → T	P → A	P → B	B → T
157B9533	PVE	Yes	10 [2,6]	25 [6,6]	5 [1,3]	25 [6,6]
11120728	PVE	Yes	10 [2,6]	40 [10,6]	25 [6,6]	25 [6,6]
157B9536	PVE	Yes	25 [6,6]	40 [10,6]	10 [2,6]	40 [10,6]

Technical Information
PVG 32 Proportional Valve Group
PVBS Main Spools Part Numbers
Flow/Pressure Control Spools—Throttled Open Neutral Position

All spools have flow control on port A, pressure control on port B and a dead band on 1,5 mm [0,06 in].

Schematic for PVBS without shuttle valve

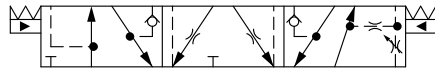

Schematic for PVBS with shuttle valve

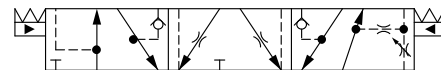

Part numbers for Symmetric FC/PC Control Spools

Part Number	Actuation	PVB with shuttle valve	Flow – l/min [US gal/min]			
			A → T	P → A	P → B	B → T
157B7150	PVE	-	10 [2,6]	10 [2,6]	10 [2,6]	10 [2,6]
157B7151	PVE	-	25 [6,6]	25 [6,6]	25 [6,6]	25 [6,6]
157B7152	PVE	-	40 [10,6]	40 [10,6]	40 [10,6]	40 [10,6]
157B7153	PVE	-	65 [17,2]	65 [17,2]	65 [17,2]	65 [17,2]
157B7154	PVE	-	100 [26,4]	100 [26,4]	100 [26,4]	100 [26,4]
11067130	PVE	Yes	10 [2,6]	10 [2,6]	10 [2,6]	10 [2,6]
157B7171	PVE	Yes	25 [6,6]	25 [6,6]	25 [6,6]	25 [6,6]
157B9556	PVE	Yes	30 [7,9]	30 [7,9]	30 [7,9]	30 [7,9]
157B7172	PVE	Yes	40 [10,6]	40 [10,6]	40 [10,6]	40 [10,6]
157B7173	PVE	Yes	65 [17,2]	65 [17,2]	65 [17,2]	65 [17,2]
157B7174	PVE	Yes	100 [26,4]	100 [26,4]	100 [26,4]	100 [26,4]
11107242	PVH/PVHC	Yes	40 [10,6]	40 [10,6]	40 [10,6]	40 [10,6]
157B9173	PVH/PVHC	Yes	65 [17,2]	65 [17,2]	65 [17,2]	65 [17,2]

Part numbers for Asymmetric FC/PC Control Spools

Part Number	Actuation	PVB with shuttle valve	Flow – l/min [US gal/min]			
			A → T	P → A	P → B	B → T
157B9592	PVE	Yes	40 [10,6]	40 [10,6]	15 [4,0]	15 [4,0]
11051961	PVE	Yes	100 [26,4]	100 [26,4]	65 [17,2]	65 [17,2]
11139550	PVE	Yes	115 [30,4]	115 [30,4]	65 [17,2]	65 [17,2]

Technical Information
PVG 32 Proportional Valve Group
PVBS Main Spools Part Numbers
Pressure/Flow Control Spools—Throttled Open B to T in Neutral Position

All spools have pressure control on port A, flow control on port B and a dead band on 1,5 mm [0,06 in].

Schematic for PVBS without shuttle valve

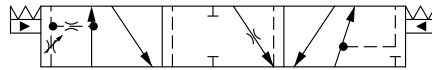

Schematic for PVBS with shuttle valve

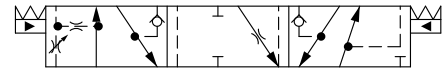

Part numbers for Symmetric FC/PC Control Spools

Part Number	Actuation	PVB with shuttle valve	Flow – l/min [US gal/min]			
			A → T	P → A	P → B	B → T
11122525	PVE	Yes	10 [2,6]	10 [2,6]	10 [2,6]	10 [2,6]
157B7562	PVE	Yes	40 [10,6]	40 [10,6]	40 [10,6]	40 [10,6]
157B7563	PVE	Yes	65 [17,2]	65 [17,2]	65 [17,2]	65 [17,2]

Part numbers for Asymmetric FC/PC Control Spools

Part Number	Actuation	PVB with shuttle valve	Flow – l/min [US gal/min]			
			A → T	P → A	P → B	B → T
157B9591	PVE	-	40 [10,6]	40 [10,6]	25 [6,6]	25 [6,6]
157B9641	PVE	-	50 [13,2]	50 [13,2]	10 [2,6]	10 [2,6]
157B9660	PVE	Yes	50 [13,2]	50 [13,2]	10 [2,6]	10 [2,6]
157B9832	PVE	Yes	55 [14,5]	55 [14,5]	25 [6,6]	25 [6,6]

PVBS Main Spools Part Numbers
Flow/Pressure Control Spools—Throttled Open A to T in Neutral Position

All spools have flow control on port A, pressure control on port B and a dead band on 1,5 mm [0,06 in].

Schematic for PVBS without shuttle valve

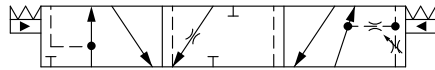

Schematic for PVBS with shuttle valve

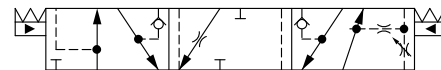

Part numbers for Symmetric FC/PC Control Spools

Part Number	Actuation	PVB with shuttle valve	Flow – l/min [US gal/min]			
			A → T	P → A	P → B	B → T
157B7450	PVE	-	10 [2,6]	10 [2,6]	10 [2,6]	10 [2,6]
157B7451	PVE	-	25 [6,6]	25 [6,6]	25 [6,6]	25 [6,6]
157B7452	PVE	-	40 [10,6]	40 [10,6]	40 [10,6]	40 [10,6]
157B7453	PVE	-	65 [17,2]	65 [17,2]	65 [17,2]	65 [17,2]
157B7470	PVE	Yes	10 [2,6]	10 [2,6]	10 [2,6]	10 [2,6]
157B7471	PVE	Yes	25 [6,6]	25 [6,6]	25 [6,6]	25 [6,6]
157B7472	PVE	Yes	40 [10,6]	40 [10,6]	40 [10,6]	40 [10,6]
157B7473	PVE	Yes	65 [17,2]	65 [17,2]	65 [17,2]	65 [17,2]

Part numbers for Asymmetric FC/PC Control Spools

Part Number	Actuation	PVB with shuttle valve	Flow – l/min [US gal/min]			
			A → T	P → A	P → B	B → T
157B9660	PVE	Yes	50 [13,2]	50 [13,2]	10 [2,6]	10 [2,6]
157B9083	PVH/PVHC	Yes	65 [17,2]	65 [17,2]	40 [10,6]	65 [17,2]

Technical Information
PVG 32 Proportional Valve Group
PVBS Main Spools Part Numbers
Flow/Pressure Control Spools—Throttled Open B to T in Neutral Position

All spools have flow control on port A, pressure control on port B and a dead band on 1,5 mm [0,06 in].

Schematic for PVBS without shuttle valve

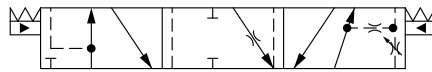

Schematic for PVBS with shuttle valve

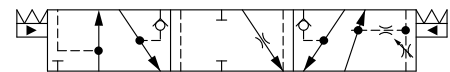

Part numbers for Asymmetric FC/PC Control Spools

Part Number	Actuation	PVB with shuttle valve	Flow – l/min [US gal/min]			
			A → T	P → A	P → B	B → T
157B9591	PVE	-	40 [10,6]	40 [10,6]	25 [6,6]	25 [6,6]
157B9641	PVE	-	50 [13,2]	50 [13,2]	10 [2,6]	10 [2,6]
157B9660	PVE	Yes	50 [13,2]	50 [13,2]	10 [2,6]	10 [2,6]
157B9832	PVE	Yes	55 [14,5]	55 [14,5]	25 [6,6]	25 [6,6]

Flow/Pressure Control Spools—Open/Closed A and Closed B Position

All spools have flow control on port A, pressure control on port B and a dead band on 1,0 mm [0,04 in].

Schematic for PVBS without shuttle valve

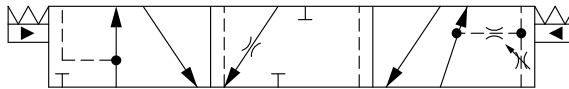

Part numbers for Symmetric FC/PC Control Spools

Part Number	Actuation	PVB with shuttle valve	Flow – l/min [US gal/min]			
			A → T	P → A	P → B	B → T
157B9835	PVE	-	25 [6,6]	25 [6,6]	25 [6,6]	25 [6,6]
157B9836	PVE	-	40 [10,6]	40 [10,6]	40 [10,6]	40 [10,6]

Part number for Back pressure FC/PC Spools (A/B->T flow track smaller than P->A/B)

Part Number	Actuation	PVB with shuttle valve	Flow – l/min [US gal/min]			
			A → T	P → A	P → B	B → T
157B9845	PVE	-	25 [6,6]	25 [6,6]	25 [6,6]	10 [2,6]

Flow/Pressure Control Spools—Closed A and Open/Closed B Position

Schematic for PVBS with shuttle valve

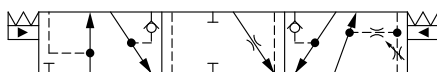

Part numbers for Symmetric FC/PC Flow Control Spools

Part Number	Actuation	PVB with shuttle valve	Flow – l/min [US gal/min]			
			A → T	P → A	P → B	B → T
11213570	PVE	Yes	40 [10,6]	40 [10,6]	40 [10,6]	40 [10,6]

Technical Information
PVG 32 Proportional Valve Group
PVBS Main Spools Part Numbers
Pressure Control Spools—Closed Neutral Position

Schematic for PVBS without shuttle valve

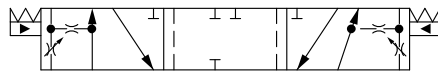

Schematic for PVBS with shuttle valve

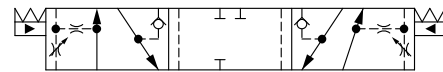

Part numbers for Symmetric Pressure Control Spools

Part Number	Actuation	PVB with shuttle valve	Flow – l/min [US gal/min]			
			A → T	P → A	P → B	B → T
157B7015	PVE	-	5 [1,3]	5 [1,3]	5 [1,3]	5 [1,3]
157B7010	PVE	-	10 [2,6]	10 [2,6]	10 [2,6]	10 [2,6]
157B9540	PVE	-	18 [4,8]	18 [4,8]	18 [4,8]	18 [4,8]
157B7011	PVE	-	25 [6,6]	25 [6,6]	25 [6,6]	25 [6,6]
157B7012	PVE	-	40 [10,6]	40 [10,6]	40 [10,6]	40 [10,6]
157B7013	PVE	-	65 [17,2]	65 [17,2]	65 [17,2]	65 [17,2]
157B7035	PVE	Yes	5 [1,3]	5 [1,3]	5 [1,3]	5 [1,3]
157B7030	PVE	Yes	10 [2,6]	10 [2,6]	10 [2,6]	10 [2,6]
157B7031	PVE	Yes	25 [6,6]	25 [6,6]	25 [6,6]	25 [6,6]
157B7032	PVE	Yes	40 [10,6]	40 [10,6]	40 [10,6]	40 [10,6]
157B7033	PVE	Yes	65 [17,2]	65 [17,2]	65 [17,2]	65 [17,2]
157B9015	PVH/PVHC	-	5 [1,3]	5 [1,3]	5 [1,3]	5 [1,3]
157B9010	PVH/PVHC	-	10 [2,6]	10 [2,6]	10 [2,6]	10 [2,6]
157B9011	PVH/PVHC	-	25 [6,6]	25 [6,6]	25 [6,6]	25 [6,6]
157B9012	PVH/PVHC	-	40 [10,6]	40 [10,6]	40 [10,6]	40 [10,6]
157B9013	PVH/PVHC	-	65 [17,2]	65 [17,2]	65 [17,2]	65 [17,2]

Back pressure Pressure Control Spools (A/B->T flow track smaller than P->A/B)

Part Number	Actuation	PVB with shuttle valve	Flow – l/min [US gal/min]			
			A → T	P → A	P → B	B → T
157B9683	PVE	Yes	100 [26,4]	130 [34,3]	130 [34,3]	100 [26,4]

Pressure Control Spools—Open/Closed A and Closed B Neutral Position

Schematic for PVBS without shuttle valve

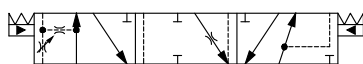

Part numbers for Symmetric PC/FC Spool Open/Closed in Neutral Position

Part Number	Actuation	PVB with shuttle valve	Flow – l/min [US gal/min]			
			A ↔ T	P ↔ A	P ↔ B	B ↔ T
157B9197	PVE	-	10 [2,6]	10 [2,6]	10 [2,6]	10 [2,6]

Technical Information
PVG 32 Proportional Valve Group
PVBS Main Spools Part Numbers
Pressure Control Spools—Throttled Open Neutral Position

All spools have pressure control on port A and B and a dead band on 1,5 mm [0,06 in].

Schematic for PVBS without shuttle valve

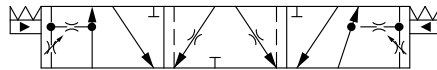

Schematic for PVBS with shuttle valve

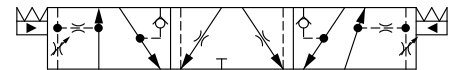

Part numbers for Symmetric Pressure Control Spools

Part Number	Actuation	PVB with shuttle valve	Flow – l/min [US gal/min]			
			A → T	P → A	P → B	B → T
157B7115	PVE	-	5 [1,3]	5 [1,3]	5 [1,3]	5 [1,3]
157B7110	PVE	-	10 [2,6]	10 [2,6]	10 [2,6]	10 [2,6]
157B7111	PVE	-	25 [6,6]	25 [6,6]	25 [6,6]	25 [6,6]
157B7112	PVE	-	40 [10,6]	40 [10,6]	40 [10,6]	40 [10,6]
157B7113	PVE	-	65 [17,2]	65 [17,2]	65 [17,2]	65 [17,2]
157B9853*	PVE	Yes	3 [0,8]	3 [0,8]	3 [0,8]	3 [0,8]
157B7135	PVE	Yes	5 [1,3]	5 [1,3]	5 [1,3]	5 [1,3]
157B7130	PVE	Yes	10 [2,6]	10 [2,6]	10 [2,6]	10 [2,6]
157B7131	PVE	Yes	25 [6,6]	25 [6,6]	25 [6,6]	25 [6,6]
157B7132	PVE	Yes	40 [10,6]	40 [10,6]	40 [10,6]	40 [10,6]
157B7133	PVE	Yes	65 [17,2]	65 [17,2]	65 [17,2]	65 [17,2]
157B7134	PVE	Yes	100 [26,4]	100 [26,4]	100 [26,4]	100 [26,4]
157B9110	PVH/PVHC	-	10 [2,6]	10 [2,6]	10 [2,6]	10 [2,6]
157B9112	PVH/PVHC	-	40 [10,6]	40 [10,6]	40 [10,6]	40 [10,6]
157B9113	PVH/PVHC	-	65 [17,2]	65 [17,2]	65 [17,2]	65 [17,2]
11243516*	PVH/PVHC	Yes	3 [0,8]	3 [0,8]	3 [0,8]	3 [0,8]
11057314	PVH/PVHC	Yes	5 [1,3]	5 [1,3]	5 [1,3]	5 [1,3]
157B9130	PVH/PVHC	Yes	10 [2,6]	10 [2,6]	10 [2,6]	10 [2,6]
157B9131	PVH/PVHC	Yes	25 [6,6]	25 [6,6]	25 [6,6]	25 [6,6]

* Dead band 0.8 mm [0.03 in]

Part numbers for Asymmetric Pressure Control Spools

Part Number	Actuation	PVB with shuttle valve	Flow – l/min [US gal/min]			
			A → T	P → A	P → B	B → T
157B9525	PVE	-	20 [5,3]	20 [5,3]	10 [2,6]	10 [2,6]
11041330	PVE	-	40 [10,6]	40 [10,6]	20 [5,3]	20 [5,3]
11190031	PVE	Yes	¹	25 [6,6]	25 [6,6]	¹
11232271	PVE	Yes	¹	65 [17,2]	65 [17,2]	¹

¹ Fully opened, no flow restriction notch

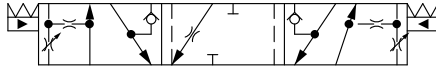
Technical Information
PVG 32 Proportional Valve Group
PVBS Main Spools Part Numbers
Pressure Control Spools—Throttled A to T in Neutral Position
Schematic for PVBS with shuttle valve

Part numbers for Pressure Control Spools Throttled A to T in Neutral Position

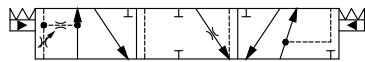
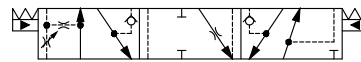
Part Number	Actuation	PVB with shuttle valve	Flow – l/min [US gal/min]			
			A → T	P → A	P → B	B → T
157B9646	PVE	Yes	15 [4]	15 [4]	15 [4]	15 [4]
157B9199	PVE	Yes	10 [2.6]	10 [2.6]	40 [10.6]	40 [10.6]

Pressure Control Spools—Throttled B to T in Neutral Position
Schematic for PVBS without shuttle valve

Schematic for PVBS with shuttle valve

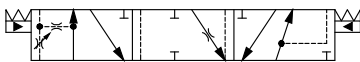
Part Number	Actuation	PVB with shuttle valve	Flow – l/min [US gal/min]			
			A → T	P → A	P → B	B → T
11122566	PVE	-	10 [2.6]	10 [2.6]	10 [2.6]	10 [2.6]
157B7541	PVE	-	25 [6,6]	25 [6,6]	25 [6,6]	25 [6,6]
157B7542	PVE	-	40 [10,6]	40 [10,6]	40 [10,6]	40 [10,6]
157B7543	PVE	-	65 [17,2]	65 [17,2]	65 [17,2]	65 [17,2]

Part Number	Actuation	PVB with shuttle valve	Flow – l/min [US gal/min]			
			A → T	P → A	P → B	B → T
157B9507	PVE	-	65 [17,2]	65 [17,2]	100 [26,4]	100 [26,4]
11166963	PVE	Yes	65 [17,2]	65 [17,2]	100 [26,4]	100 [26,4]

Linear Pressure Control Spools—Closed Neutral Position
Schematic for PVBS without shuttle valve

Part numbers for Symmetric Pressure Control Spools

Part Number	Actuation	PVB with shuttle valve	Flow – l/min [US gal/min]			
			A → T	P → A	P → B	B → T
11200910	PVE	-	5 [1,3]	5 [1,3]	5 [1,3]	5 [1,3]
11227386	PVH/PVHC	-	25 [6,6]	25 [6,6]	25 [6,6]	25 [6,6]

Technical Information
PVG 32 Proportional Valve Group
PVBS Main Spools Part Numbers
Pressure/Flow Control Spools—Closed Neutral Position

All spools have pressure control on port A, flow control on port B and a dead band on 1,5 mm [0,06 in].

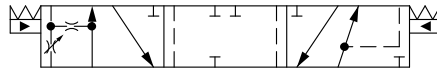
Schematic for PVBS without shuttle valve



Schematic for PVBS with shuttle valve

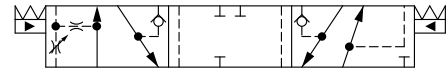

Part numbers for Symmetric PC/FC Spools

Part Number	Actuation	PVB with shuttle valve	Flow – l/min [US gal/min]			
			A → T	P → A	P → B	B → T
157B7040	PVE	-	10 [2,6]	10 [2,6]	10 [2,6]	10 [2,6]
157B7041	PVE	-	25 [6,6]	25 [6,6]	25 [6,6]	25 [6,6]
157B7042	PVE	-	40 [10,6]	40 [10,6]	40 [10,6]	40 [10,6]
157B7043	PVE	-	65 [17,2]	65 [17,2]	65 [17,2]	65 [17,2]
157B7044	PVE	-	100 [26,4]	100 [26,4]	100 [26,4]	100 [26,4]
157B7061	PVE	Yes	25 [6,6]	25 [6,6]	25 [6,6]	25 [6,6]
157B7062	PVE	Yes	40 [10,6]	40 [10,6]	40 [10,6]	40 [10,6]
157B7063	PVE	Yes	65 [17,2]	65 [17,2]	65 [17,2]	65 [17,2]
157B7064	PVE	Yes	100 [26,4]	100 [26,4]	100 [26,4]	100 [26,4]
157B9040	PVH/PVHC	-	10 [2,6]	10 [2,6]	10 [2,6]	10 [2,6]
157B9041	PVH/PVHC	-	25 [6,6]	25 [6,6]	25 [6,6]	25 [6,6]
157B9042	PVH/PVHC	-	40 [10,6]	40 [10,6]	40 [10,6]	40 [10,6]
157B9043	PVH/PVHC	-	65 [17,2]	65 [17,2]	65 [17,2]	65 [17,2]
157B9044	PVH/PVHC	-	100 [26,4]	100 [26,4]	100 [26,4]	100 [26,4]
157B9062	PVH/PVHC	Yes	40 [10,6]	40 [10,6]	40 [10,6]	40 [10,6]
157B9063	PVH/PVHC	Yes	65 [17,2]	65 [17,2]	65 [17,2]	65 [17,2]

Part numbers for Asymmetric PC/FC Spools

Part Number	Actuation	PVB with shuttle valve	Flow – l/min [US gal/min]			
			A → T	P → A	P → B	B → T
157B9589	PVE	Yes	25 [6,6]	25 [6,6]	40 [10,6]	40 [10,6]
157B9528	PVE	Yes	65 [17,2]	40 [10,6]	65 [17,2]	65 [17,2]
11223873	PVE	Yes	65 [17,2]	40 [10,6]	65 [17,2]	40 [10,6]

Back pressure PC/FC Spools (A/B->T flow track smaller than P->A/B)

Part Number	Actuation	PVB with shuttle valve	Flow – l/min [US gal/min]			
			A → T	P → A	P → B	B → T
157B9532	PVE	Yes	25 [6,6]	5 [1,3]	25 [6,6]	10 [2,6]
11051179	PVE	Yes	25 [6,6]	10 [2,6]	25 [6,6]	5 [1,3]
157B9535	PVE	Yes	40 [10,6]	10 [2,6]	40 [10,6]	25 [6,6]
11051177	PVE	Yes	25 [6,6]	25 [6,6]	40 [10,6]	10 [2,6]

PVBS Main Spools Part Numbers
Pressure/Flow Control Spools—Closed Neutral Position with B-float

All spools have pressure control on port A, flow control on port B and a dead band on 1,5 mm [0,06 in].

Schematic for PVBS without shuttle valve

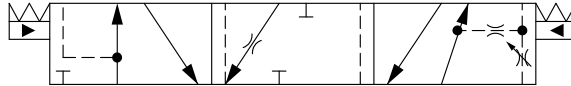

Part number for Symmetric PC/FC Spools

Part Number	Actuation	PVB with shuttle valve	Flow – l/min [US gal/min]			
			A → T	P → A	P → B	B → T
157B9637	PVE	—	10 [2,6]	10 [2,6]	10 [2,6]	10 [2,6]

Pressure/Flow Control Spools—Throttled Open Neutral Position

All spools have pressure control on port A, flow control on port B and a dead band on 1,5 mm [0,06 in].

Schematic for PVBS without shuttle valve

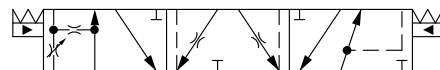

Schematic for PVBS with shuttle valve

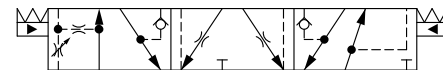

Part numbers for Symmetric PC/FC Control Spools

Part Number	Actuation	PVB with shuttle valve	Flow – l/min [US gal/min]			
			A → T	P → A	P → B	B → T
11122564	PVE	-	10 [2,6]	10 [2,6]	10 [2,6]	10 [2,6]
157B7141	PVE	-	25 [6,6]	25 [6,6]	25 [6,6]	25 [6,6]
157B7142	PVE	-	40 [10,6]	40 [10,6]	40 [10,6]	40 [10,6]
157B7143	PVE	-	65 [17,2]	65 [17,2]	65 [17,2]	65 [17,2]
157B7144	PVE	-	100 [26,4]	100 [26,4]	100 [26,4]	100 [26,4]
157B7161	PVE	Yes	25 [6,6]	25 [6,6]	25 [6,6]	25 [6,6]
157B7162	PVE	Yes	40 [10,6]	40 [10,6]	40 [10,6]	40 [10,6]
157B7163	PVE	Yes	65 [17,2]	65 [17,2]	65 [17,2]	65 [17,2]
157B7164	PVE	Yes	100 [26,4]	100 [26,4]	100 [26,4]	100 [26,4]
157B9163	PVH/PVHC	Yes	65 [17,2]	65 [17,2]	65 [17,2]	65 [17,2]

Part numbers for Asymmetric PC/FC Control Spools

Part Number	Actuation	PVB with shuttle valve	Flow – l/min [US gal/min]			
			A → T	P → A	P → B	B → T
157B9811	PVE	Yes	10 [2,6]	10 [2,6]	40 [10,6]	65 [17,2]
157B9988	PVE	Yes	25 [6,6]	10 [2,6]	25 [6,6]	25 [6,6]

Pressure/Flow Control Spools—Open/Closed Neutral Position

Schematic for PVBS without shuttle valve

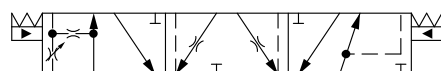

Technical Information
PVG 32 Proportional Valve Group
PVBS Main Spools Part Numbers
Part number for PC/FC Spool Open/Closed in Neutral Position

Part Number	Actuation	PVB with shuttle valve	Flow – l/min [US gal/min]			
			A → T	P → A	P → B	B → T
11104931	PVE	—	40 [10.6]	40 [10.6]	40 [10.6]	40 [10.6]

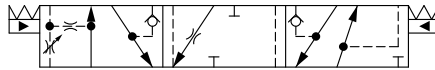
Pressure/Flow Control Spools—Open/Closed A and Closed B Position
Schematic for PVBS with shuttle valve

Part numbers for Symmetric PC/FC Control Spools

Part Number	Actuation	PVB with shuttle valve	Flow – l/min [US gal/min]			
			A → T	P → A	P → B	B → T
11213571	PVE	Yes	40 [10.6]	40 [10.6]	40 [10.6]	40 [10.6]

Technical Information
PVG 32 Proportional Valve Group
PVBS for PVBZ Main Spools Part Numbers
PVBZ Flow Control Spools—Closed Neutral Position

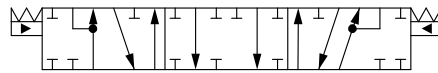
Schematic for PVBZ without shuttle valve



Schematic for PVBZ with shuttle valve

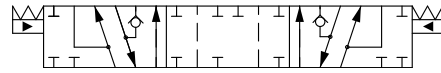

Part numbers for Symmetric Flow Control Spools

Part Number	Actuation	PVB with shuttle valve	Flow – l/min [US gal/min]			
			A → T	P → A	P → B	B → T
157B9405	PVE	-	5 [1,3]	5 [1,3]	5 [1,3]	5 [1,3]
157B9400	PVE	-	10 [2,6]	10 [2,6]	10 [2,6]	10 [2,6]
157B9401	PVE	-	25 [6,6]	25 [6,6]	25 [6,6]	25 [6,6]
157B9402	PVE	-	40 [10,6]	40 [10,6]	40 [10,6]	40 [10,6]
157B9403	PVE	-	65 [17,2]	65 [17,2]	65 [17,2]	65 [17,2]
157B9404	PVE	-	100 [26,4]	100 [26,4]	100 [26,4]	100 [26,4]
11051945	PVE	Yes	5 [1,3]	5 [1,3]	5 [1,3]	5 [1,3]
11019630	PVE	Yes	10 [2,6]	10 [2,6]	10 [2,6]	10 [2,6]
11019631	PVE	Yes	25 [6,6]	25 [6,6]	25 [6,6]	25 [6,6]
11019633	PVE	Yes	40 [10,6]	40 [10,6]	40 [10,6]	40 [10,6]
11019634	PVE	Yes	65 [17,2]	65 [17,2]	65 [17,2]	65 [17,2]
11019635	PVE	Yes	100 [26,4]	100 [26,4]	100 [26,4]	100 [26,4]
11105665	PVH/PVHC	-	5 [1,3]	5 [1,3]	5 [1,3]	5 [1,3]
11105445	PVH/PVHC	-	10 [2,6]	10 [2,6]	10 [2,6]	10 [2,6]
11105446	PVH/PVHC	-	25 [6,6]	25 [6,6]	25 [6,6]	25 [6,6]
11140563	PVH/PVHC	Yes	25 [6,6]	25 [6,6]	25 [6,6]	25 [6,6]
11140564	PVH/PVHC	Yes	65 [17,2]	65 [17,2]	65 [17,2]	65 [17,2]

Part numbers for Back pressure Flow Control Spools (A/B->T flow track smaller than P->A/B)

Part Number	Actuation	PVB with shuttle valve	Flow – l/min [US gal/min]			
			A → T	P → A	P → B	B → T
157B9573*	PVH/PVHC	-	38 [10,0]	25 [6,6]	65 [17,2]	15 [4,0]
157B9651	PVE	-	38 [10,0]	25 [6,6]	65 [17,2]	15 [4,0]
11084227	PVE	Yes	5 [1,3]	25 [6,6]	25 [6,6]	25 [6,6]
11129527	PVE	Yes	40 [10,6]	10 [2,6]	40 [10,6]	10 [2,6]
11085297	PVE	Yes	20 [5,2]	40 [10,6]	40 [10,6]	10 [2,6]

* Deadband 1,5 mm [0,06].

PVBZ Flow Control Spools—Closed Neutral Position with A-float

Schematic for PVBZ with shuttle valve

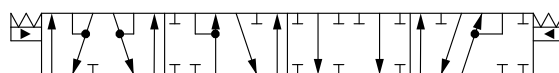

Technical Information
PVG 32 Proportional Valve Group
PVBS for PVBZ Main Spools Part Numbers
Part numbers for Symmetric Flow Control Spools

Part Number	Actuation	PVB with shuttle valve	Flow – l/min [US gal/min]			
			A → T	P → A	P → B	B → T
157B9415	PVE	Yes	5 [1,3]	5 [1,3]	5 [1,3]	5 [1,3]
157B9410	PVE	Yes	10 [2,6]	10 [2,6]	10 [2,6]	10 [2,6]
157B9411	PVE	Yes	25 [6,6]	25 [6,6]	25 [6,6]	25 [6,6]
157B9412	PVE	Yes	40 [10,6]	40 [10,6]	40 [10,6]	40 [10,6]
157B9413	PVE	Yes	65 [17,2]	65 [17,2]	65 [17,2]	65 [17,2]
157B9414	PVE	Yes	100 [26,4]	100 [26,4]	100 [26,4]	100 [26,4]
11027130	PVH/PVHC	Yes	25 [6,6]	25 [6,6]	25 [6,6]	25 [6,6]
11124250	PVH/PVHC	Yes	100 [26,4]	100 [26,4]	100 [26,4]	100 [26,4]

Part numbers for Back pressure Flow Control Spools (A/B->T flow track smaller than P->A/B)

Part Number	Actuation	PVB with shuttle valve	Flow – l/min [US gal/min]			
			A → T	P → A	P → B	B → T
11085128	PVE	Yes	2 [0,5]	10 [2,6]	10 [2,6]	5 [1,3]

Part number Flow Control Spools for PVML

Part Number	Actuation	PVB with shuttle valve	Flow – l/min [US gal/min]			
			A → T	P → A	P → B	B → T
11128843	PVE	Yes	40 [10,6]	40 [10,6]	40 [10,6]	40 [10,6]
157B9596	PVE	Yes	100 [26,4]	80 [21,1]	80 [21,1]	100 [26,4]
11017592	PVE	Yes	120 [31,7]	120 [31,7]	120 [31,7]	120 [31,7]

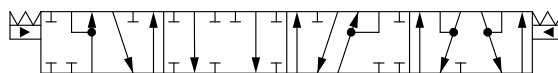
PVBZ Flow Control Spools—Closed Neutral Position with B-float
Schematic for PVBZ with shuttle valve

Part numbers for Symmetric Flow Control Spools

Part Number	Actuation	PVB with shuttle valve	Flow – l/min [US gal/min]			
			A → T	P → A	P → B	B → T
11147069	PVE	Yes	100 [26,4]	100 [26,4]	100 [26,4]	100 [26,4]

Part number Flow Control Spools for PVML

Part Number	Actuation	PVB with shuttle valve	Flow – l/min [US gal/min]			
			A → T	P → A	P → B	B → T
11146502	PVE	Yes	100 [26,4]	100 [26,4]	100 [26,4]	100 [26,4]

Technical Information
PVG 32 Proportional Valve Group
PVBS for PVBZ Main Spools Part Numbers
PVBZ Linear Flow Control Spools—Closed Neutral Position

Schematic for PVBZ without shuttle valve

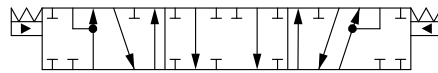

Schematic for PVBZ with shuttle valve

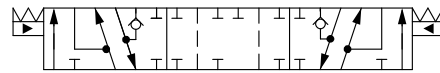

Part numbers for Symmetric Flow Control Spools

Part Number	Actuation	PVB with shuttle valve	Flow – l/min [US gal/min]			
			A → T	P → A	P → B	B → T
157B9663	PVE	-	5 [1,3]	5 [1,3]	5 [1,3]	5 [1,3]
157B9664	PVE	-	25 [6,6]	25 [6,6]	25 [6,6]	25 [6,6]
157B9809	PVE	Yes	80 [21,1]	80 [21,1]	80 [21,1]	80 [21,1]

Part numbers for Back pressure Flow Control Spools (A/B → T flow track smaller than A/B → P)

Part Number	Actuation	PVB with shuttle valve	Flow – l/min [US gal/min]			
			A → T	P → A	P → B	B → T
11130939	PVE	Yes	25 [6,6]	40 [10,6]	40 [10,6]	25 [6,6]

Part numbers for Flow Control Spools for PVML

Part Number	Actuation	PVB with shuttle valve	Flow – l/min [US gal/min]			
			A → T	P → A	P → B	B → T
157B9866	PVE	Yes	25 [6,6]	40 [10,6]	40 [10,6]	25 [6,6]

PVBZ Single Acting Cylinder Flow Control Spools—Closed Neutral A-port Position

Schematic for PVBS without shuttle valve

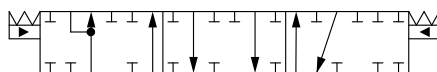

Symmetric flow control spools

Part Number	Actuation	PVB with shuttle valve	Flow – l/min [US gal/min]			
			A → T	P → A	P → B	B → T
157B9859	PVE	-	25 [6,6]	25 [6,6]	-	-

PVBZ Single Acting Cylinder Linear Flow Control Spools—Closed Neutral B-port Position

Schematic for PVBS without shuttle valve

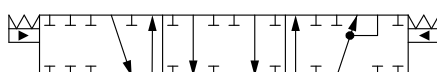

Symmetric flow control spools

Part Number	Actuation	PVB with shuttle valve	Flow – l/min [US gal/min]			
			A → T	P → A	P → B	B → T
157B9859	PVE	-	25 [6,6]	25 [6,6]	-	-

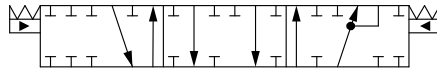
Technical Information
PVG 32 Proportional Valve Group
PVBS for PVBZ Main Spools Part Numbers
PVBZ–HS Single Acting Cylinder Flow Control Spools—Closed Neutral Position
Schematic for PVBS with or without shuttle valve

Back pressure Flow Control Spools (B->T flow track smaller than P->B)

Part Number	Actuation	PVB with shuttle valve	Flow – l/min [US gal/min]			
			A → T	P → A	P → B	B → T
11098878	PVE	Yes	-	-	25 [6,6]	5 [1,3]

PVDI Directional Indicator

The PVDI Directional Indicator offers an independent electrical direction feedback and monitoring on the spool position relative neutral for a redundant feedback to the system controller. It can be used in combination with manual (PVM), hydraulic (PVH) and electrical (PVE) controls.

The PVDI features:

- Redundant spool movement detection
- Fits with PVBS 1.5 mm [0.059 in]
- Electrical feedback can supply a relay

The PVDI can not be used with PVMF or PVMR and must be shielded.

PVDI Directional Indicator module

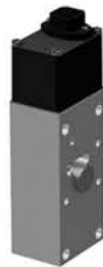

Weight: 0.6 kg [1.32 lb]

PVDI Directional Indicator dimensions

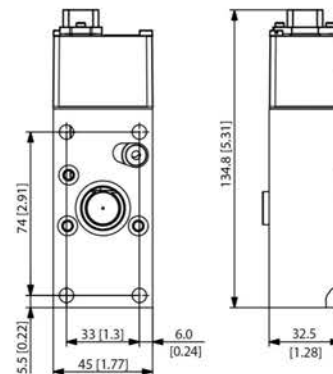
Technical specifications

Voltage	12 V – 24 V (min.10 V / max. 38 V)
Current consumption	10 mA – 100 mA
Maximum current draw on pins	5 A
Switch position	± 0.7 mm (+0.3/-0.2) [± 0.028 in (±0.01)]
Connector type	1x4 DIN
Grade of enclosure	IP 65

According to the standard IEC 60529 Edition 2.2 2013-08, protection in the form of screening is recommended.

Part numbers for PVDI

Part number	Description
157B0101	PVDI type, PVE cover.
157B0102	
157B0103	
157B0104	PVDI-H; PVH cover; Must be used with an intermediate plate.
157B0105	PVDI type with two NO switches; PVE cover.

PVG 32 Actuation

PVG 32 actuation can be done manually, hydraulically, electro-hydraulically and electrically.

PVG 32 actuation overview:

- [PVM Manual Actuation](#) on page 144
 - [PVML, Spring Centering Cover](#) on page 150
 - [PVMD/F/R Covers](#) on page 149
- [PVH Hydraulic Actuation](#) on page 151
- [PVHC Electro-Hydraulic Actuation](#) on page 152
- [PVE Electro-hydraulic Actuation](#) on page 154
- [PVE Series 5](#) on page 156
 - [PVED-CC Series 5](#) on page 156
- [PVE Series 7](#) on page 161
 - [PVEO](#) on page 161
 - [PVEO-HP](#) on page 166
 - [PVEM](#) on page 170
 - [PVEA](#) on page 174
 - [PVEH](#) on page 178
 - [PVES](#) on page 182

Technical Information
PVG 32 Proportional Valve Group
PVG 32 Actuation
PVM Manual Actuation

The PVM manual actuation cover is intended for use on any work section where the operator has to have the ability to interact with the spool manually.

The PVM variants are based on a generic platform with a selection of additional features, enabling you to tailor the PVM to suit the demands of any hydraulic system, which includes the following main variants:

- PVM manual actuation or override of a function
- Spring centering cover without manual override (PVML)
 - Optional with lever base
 - Optional with lever base and lever
 - Optional flow adjustment screws

The adjustment screws are intended for limiting the spool travel and thereby the maximum achievable flow.

PVM cover

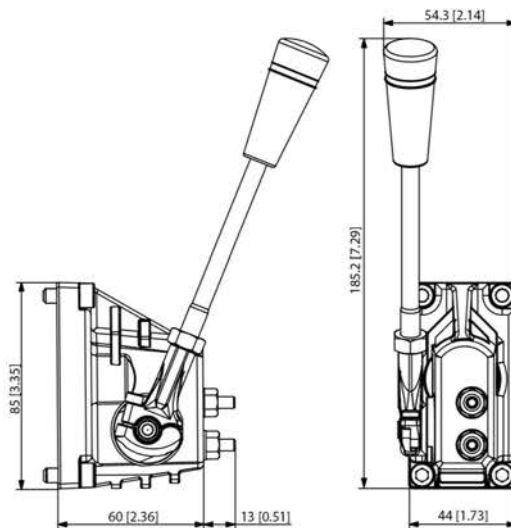
PVM dimensions

Control lever data

Control lever positions	Standard control range	Control lever range	Control lever range + float position
2 x 6	± 13.4°	± 19.5°	22.3°

Technical Information
PVG 32 Proportional Valve Group

PVG 32 Actuation

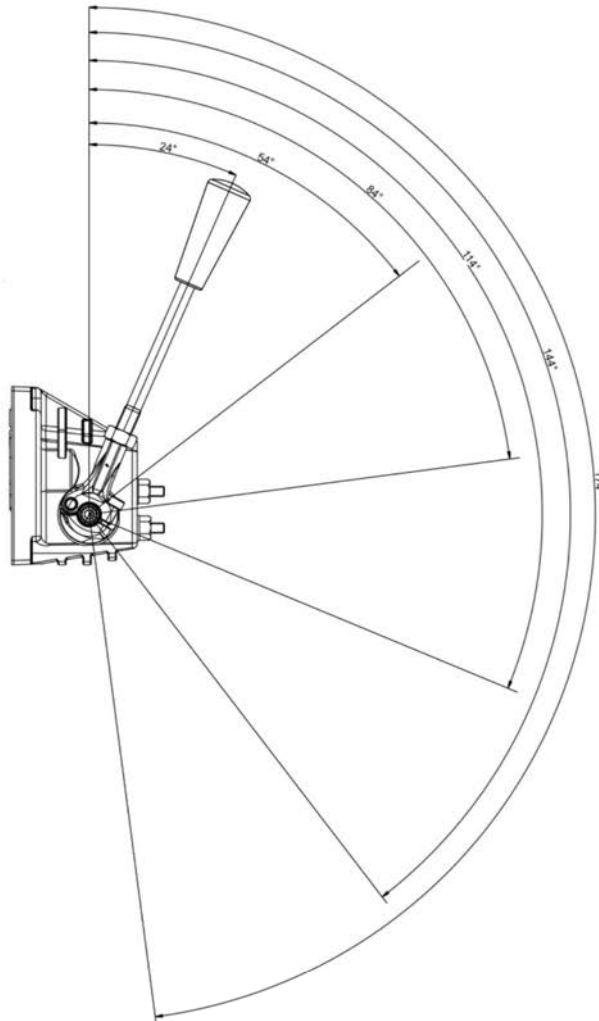
PVM handle positions

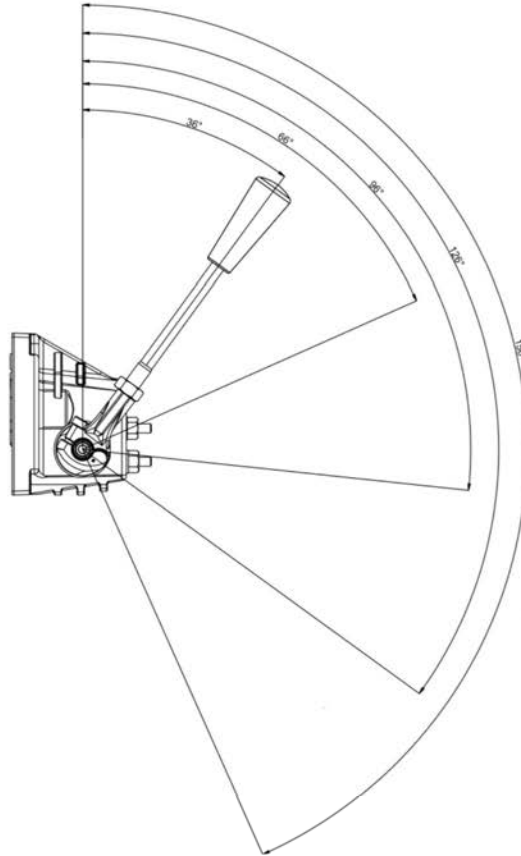

Technical Information
PVG 32 Proportional Valve Group
PVG 32 Actuation

PVM versions torque data in N·m [lbf·in]

Spool displacement	PVM+PVMD PVM+PVE	PVM+PVH	PVM+PVMR	PVM+PVMF
From neutral position	2.2 ± 0.2 [19.5 ± 1.8]	2.5 ± 0.2 [22.1 ± 1.8]	6 ± 0.2 [53.1 ± 1.8]	3.1 ± 0.2 [27.4 ± 1.8]
Max. spool travel	2.8 ± 0.2 [24.8 ± 1.8]	6.9 ± 0.2 [61.0 ± 1.8]	-	-
Into float position	-	-	-	9.6 ± 0.2 [85 ± 1.8]
Away from float position	-	-	-	6.2 ± 0.2 [54.9 ± 1.8]
From any other position	-	-	3.9 ± 0.2 [34.5 ± 1.8]	-
No control lever position			2 x 6	
Control lever range			± 19.5°	

Technical Information
PVG 32 Proportional Valve Group
PVG 32 Actuation

Proportional control lever range	± 13.4°
Control lever range - float position	22.3°

For more information about PVE, please see *Technical Information PVE, Series 7 for PVG 32/100/120, BC218286485446*.

Part number	Material	Adjustment screws	Lever base	Lever base and lever	Weight
157B3161	Cast iron	Yes	—	Yes	0,4 kg [0,88 lb]
157B3171	Aluminum	Yes	—	Yes	
157B3173	Aluminum	Yes	—	—	
157B3174	Aluminum	Yes	Yes	—	
157B3184	Anodized aluminum	Yes	—	Yes	
157B3186	Anodized aluminum	Yes	—	—	
157B3191	Aluminum	—	—	Yes	
157B3193	Aluminum	—	—	—	
157B3194	Aluminum	—	Yes	—	

PVG 32 Actuation
PVM functionality
PVMF

The PVMF is available in standard or optional mount.

PVMR

The friction detent allows the directional spool to be held in any position, resulting in infinitely variable, reversible, pressure compensated flow.

This can be sustained indefinitely without having to continue to hold the mechanical lever. Friction detent spool position may be affected by high differential actuator flow forces and system vibration resulting in work function flow reduction.

PVMF standard mount

$P \rightarrow A \rightarrow F$ (Push-in)

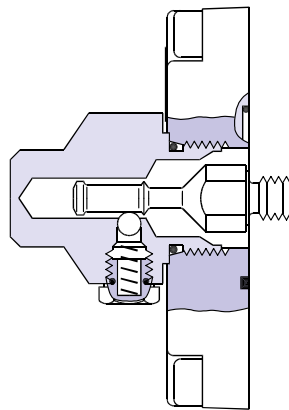

157-205.10

PVMF optional mount

$P \rightarrow A \rightarrow F$ (Pull-out)

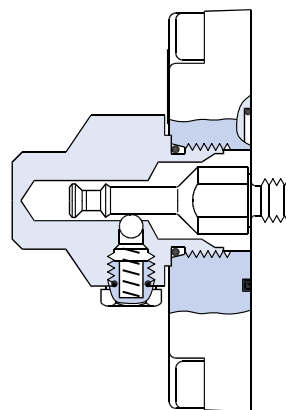

157-206.10

PVMR

Friction detent

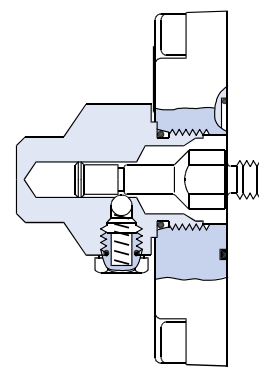

PVG 32 Actuation
PVMD/F/R Covers

The PVMD/F/R covers, also referred to as detention covers, are intended for manually activated PVB sections.

The generic PVMD/F/R cover platform includes the following main variants:

- **PVMD** cover for mechanical actuation
- **PVMF** mechanical float position cover
- **PVMR** friction detent cover

PVMR symbol (left), PVMF standard mount symbol (center), PVMF optional mount symbol (right)

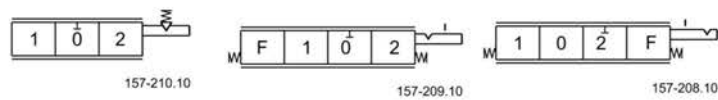

PVMD detention cover



Dimensions, mm [in]

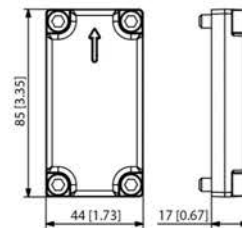

PVMF/R Cover

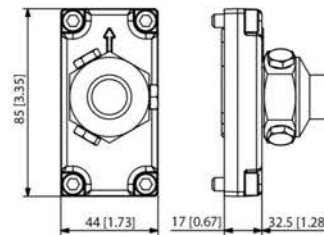

Dimensions, mm [in]

Part Numbers for PVMD/F/R Covers

Part number	Type	Material	Weight
157B0001	PVMD	Aluminum	0,15 – 0,38 kg [0.33 – 0.84 lb]
157B0009		Anodized aluminum	
157B0021		Cast iron	
157B0005	PVMF	Aluminum	0,34 – 0,57 kg [0.75 – 1.26 lb]
157B0004	PVMR	Aluminum	
157B0012		Anodized aluminum	
157B0024		Cast iron	

PVG 32 Actuation

PVML, Spring Centering Cover

The PVML spring centering cover is intended for use on any work section where the operator is not allowed to have a possibility to interact with the spool manually.

The adjustment screws are intended for limiting the spool travel and thereby the maximum achievable flow.

Part numbers for PVML

Part number	Material	Adjustment screws
157B3202	Aluminum	-
157B3203		Yes (single direction)

Technical Information
PVG 32 Proportional Valve Group
PVG 32 Actuation
PVH Hydraulic Actuation

The PVH hydraulic actuation is intended for use on any work section where the operator wants to have a possibility to interact with the main spool via a hydraulic joystick. The spool spring package must match with this activation method.

PVH cover

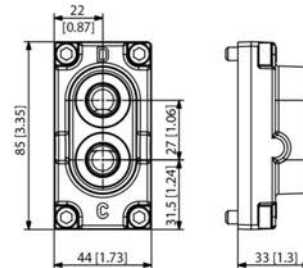
PVH 32 cover dimensions

The hydraulic remote control lever should be connected directly to the tank.

Technical data

Main spool spring control pressure range	5 – 15 bar [73 – 218 psi]
Operating torque from neutral	2.5 ± 0.2 N·m [22.1 ± 1.8 lb·in]
Operating torque max spool position	6.9 ± 0.2 N·m [61.0 ± 1.8 lb·in]
Maximum pilot oil pressure	30 bar [435 psi]

Part numbers for PVH Hydraulic Actuation

Part number	Material	Connection	Weight
157B0007	Aluminum	9/16-18 UNF	0.2 – 0.75 kg [0.44 – 1.65 lb]
157B0008		G1/4"	
157B0010	Anodized aluminum	9/16-18 UNF	
157B0011		G1/4"	
157B0014	Cast iron	9/16-18 UNF	
157B0016		G1/4"	

PVG 32 Actuation
PVHC Electro-Hydraulic Actuation

The PVHC is an electrical actuator module for main spool control. The PVHC control is done by dual Pulse Width Modulated, high current supply 100-400 Hz PWM control signals. The spool position will shift when conditions are changed such as temperature change.

Inlet with Hydraulic Pilot Pressure is needed.

PVHC, Electro-Hydraulic Actuator



PVHC dimensions

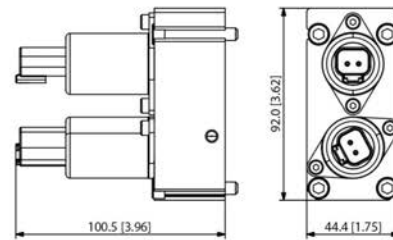

Weight: 0,93 kg [2.05 lb]

PVHC schematic

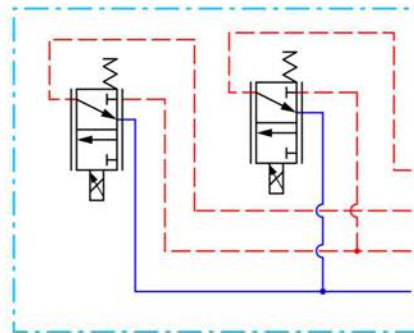

Dither frequency with a certain amplitude is needed for optimal application performance.

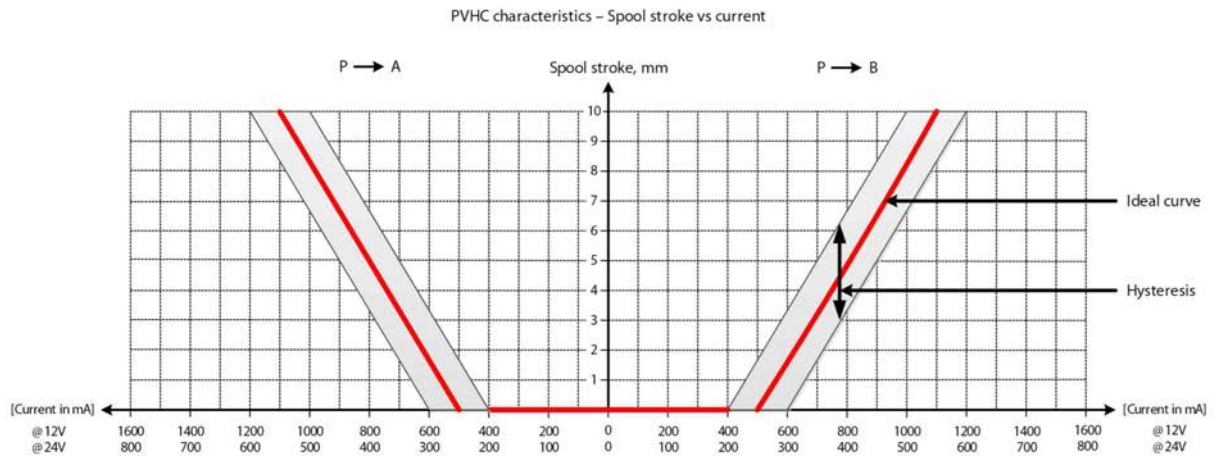
Technical Information
PVG 32 Proportional Valve Group
PVG 32 Actuation
PVHC spool stroke vs current characteristics

The hysteresis is affected by viscosity, friction, flow forces, dither frequency and modulation frequency.

Technical data

Supply Voltage U_{DC}	12 V _{DC}	24 V _{DC}
Current input	0 – 1500 mA	0 – 750 mA
Resistance	4.75 Ω ± 5 %	20.8 Ω ± 5 %
Response time	150 to 200 ms	
PWM frequency	100 to 400 Hz	
Recommended dither frequency	250 Hz	
Recommended dither amplitude	40 mA	
Pilot oil pressure range	20 – 25 bar [290 – 362 psi]	
Ambient temperature range	-30°C to 80°C [-22 °F to 176°F]	
Temperature range	-20°C to 80°C [-4 °F to 176°F]	
Fluid cleanliness	23/19/16 (according to ISO 4406)	

Part numbers for PVHC Actuators

Part number	Power supply	Connector type	Protection Class
11112037	12V	AMP	IP 66
11112036	24V		
11112038	12V	2x2 DEUTSCH	IP 67
11112039	24V		

PVE Electro-hydraulic Actuation

The analog PVE Series 5 and 7 are electro-hydraulic actuators used to control a single work section of a PVG proportional valve group. The PVE actuator program for PVG 32 includes variants with different performance levels and features.

The actuator positions the main spool in a PVG work section to control either the flow or the pressure of the oil distributed to and from the work function. The control signal to the actuator is an analog voltage signal, enabling the user to operate the work function remotely by means of a joystick, a controller or the similar.

The electro-hydraulic solenoid valve bridge of the actuator is available in different designs utilizing different regulation principles, depending on performance variant. The actuator positions the main spool by distributing pilot oil pressure to either side of it, pressurizing one side by pilot pressure while relieving the opposite side to tank and vice versa. All proportional actuators feature a closed-loop spool control and continuous fault monitoring.

The different hydraulic principles combined with the different solenoid valve regulation principles determine whether the actuator controls the spool proportionally according to a demand signal or ON/OFF according to a voltage signal. The voltage control characteristic of the PVE actuators is shown in the figure below on the left side.

PVG 32 with PVEO/PVEM (PVEO without LVDT)

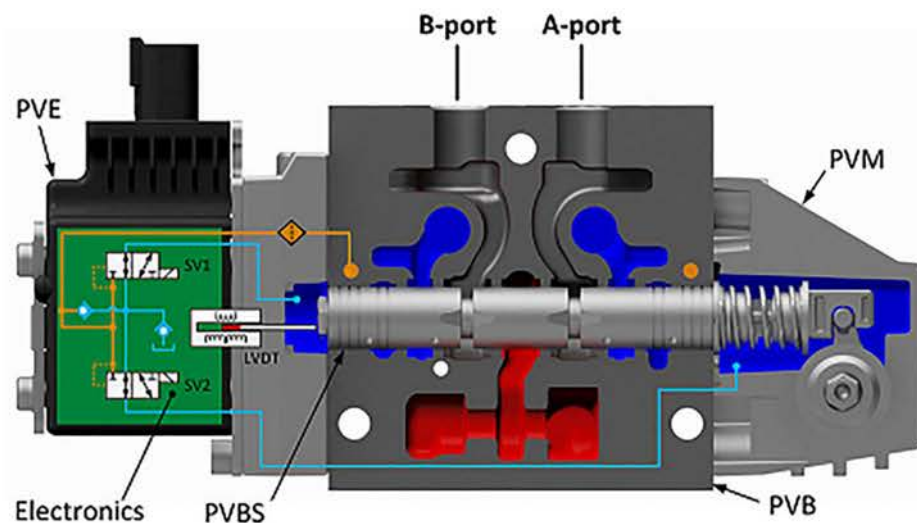

Technical Information
PVG 32 Proportional Valve Group

PVE Electro-hydraulic Actuation

PVG 32 with PVEH/PVES

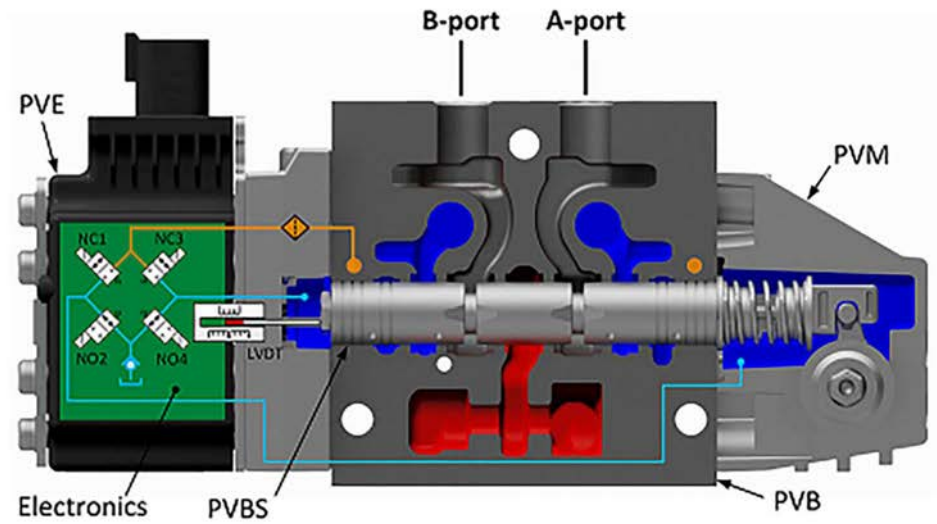

PVE Electro-hydraulic Actuation
PVE Series 5
PVED-CC Series 5

The PVED-CC Series 5 is a high performance digital actuator for the PVG 32 and PVG 100 valves, which can use two different protocols: CANopen and ISObus/J1939.

The PVED-CC Series 5 offers CAN bus control through loop cables simplifying the wire harness and build-in intelligence, where actuator specific features tailor the actuator behavior to the exact function need.

PVED-CC Series 5

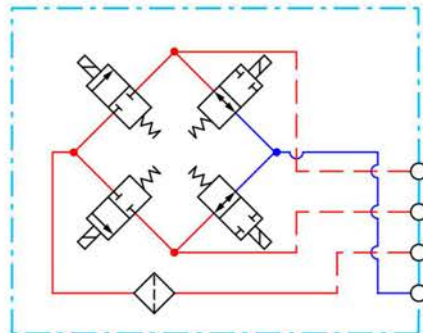
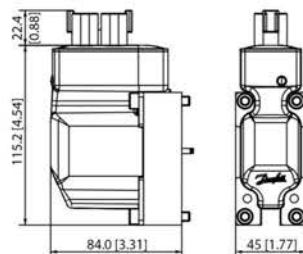
PVED-CC S5 schematic

PVED-CC Series 5 dimensions

For more information, see *PVED-CC Series 5 CANopen Technical Information*, [BC180386484705](#).

For more information, see *PVED-CC Series 5 ISObus Technical Information*, [BC187186484889](#).

PVE Electro-hydraulic Actuation
Operating data overview
Electrical data

Voltage		12 V_{DC}	24 V_{DC}
Current consumption	Operating	520 mA	260 mA
	Neutral - Power state	80 mA	45 mA
Energy consumption	Operating	6.24 W	6.24 W
	Neutral - Power state	1 W	1.1 W
Supply voltage (V_{bat})	Nominal	11 – 32 V _{DC}	
	Range	9 – 35.9 V _{DC}	
	Maximum ripple	5%	
CAN bus	Alive	5.5 – 36 V _{DC} *	

* PVED communicating on CAN bus, but not fully operable.

Temperature range

		Min.	Max.
Temperature	Ambient	-40°C	90°C
	Oil		
	Storage		110°C

Hydraulic data

Pilot pressure		13.5 ± 1.5 bar
Tank pressure	Continuous	20 bar
	Intermittent	40 bar
Oil consumption	Electrical de-energized	0 l/min
	Spool locked position	
	Continuous changing spool position	0.7 l/min
Contamination	(ISO 4406)	23/19/16
Viscosity range	Nominal	12 – 75 mm ² /s
	Minimum	4.2 – 12 mm ² /s*
	Maximum	75 – 1000 mm ² /s

* PVED have reduced operating performance

Government regulations

Description	Standard
Low Voltage	2006/95/EC
EMC Directive	2004/108/EC
Safety	ISO4413:2010

PVE Electro-hydraulic Actuation
Connectors

Available 2x4 pin connectors: AMP Junior Power Timer and DEUTSCH DT06-4S-E003. Pins are internally connected in pairs between connectors. Mating connectors are not supplied by Danfoss.

AMP connector

AMP Junior Power Timer (2x4 pin)

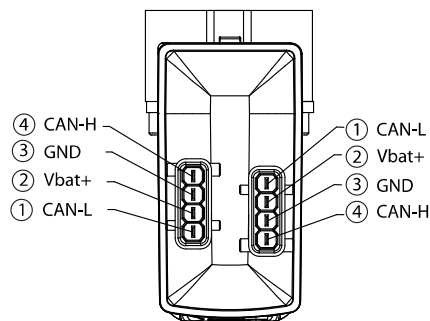

Pinout:

1. CAN Low
2. Vbat+
3. GND
4. CAN High

Terminal	Seal	Housing	IP rating
929930-1 (4 pcs)	828901-1 (4 pcs)	2-967059-1 (gray) or 1-967059-1 (black) *	IP66

* There is no black/gray coding of the connector

DEUTSCH connector

DT06-4S-E003 (2x4 pin)

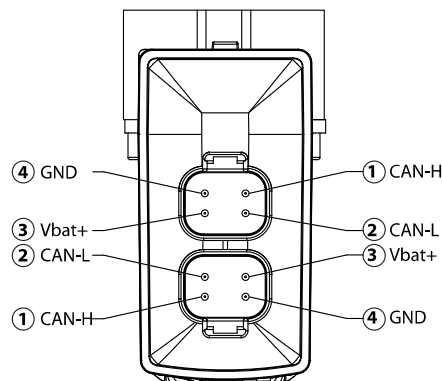





Pinout:

1. CAN High
2. CAN Low
3. Vbat+
4. GND

IP rating: IP67; IP69K without connector

V310451.A

PVE Electro-hydraulic Actuation
LED coloring for PVED-CC Series 5
LED Characteristic

Color	LED Characteristic	Description
Green constant		No error – Actuating
Green flashing @ 1.5 Hz		Neutral – Power save
Red constant		Internal error
Red flashing @ 1.5 Hz		External or Float error
Yellow		Disable mode

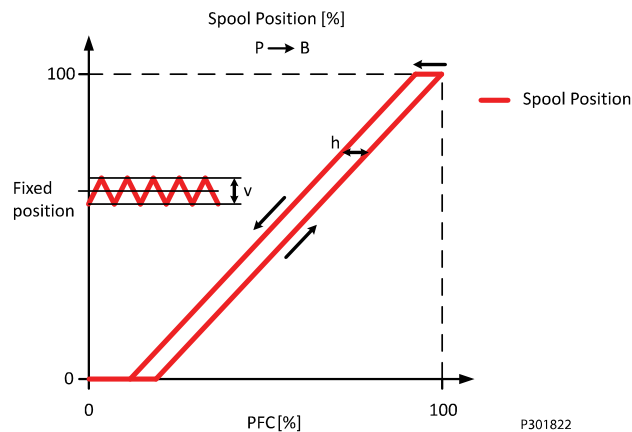
PVED-CC Hysteresis and Ripple

Definition of hysteresis

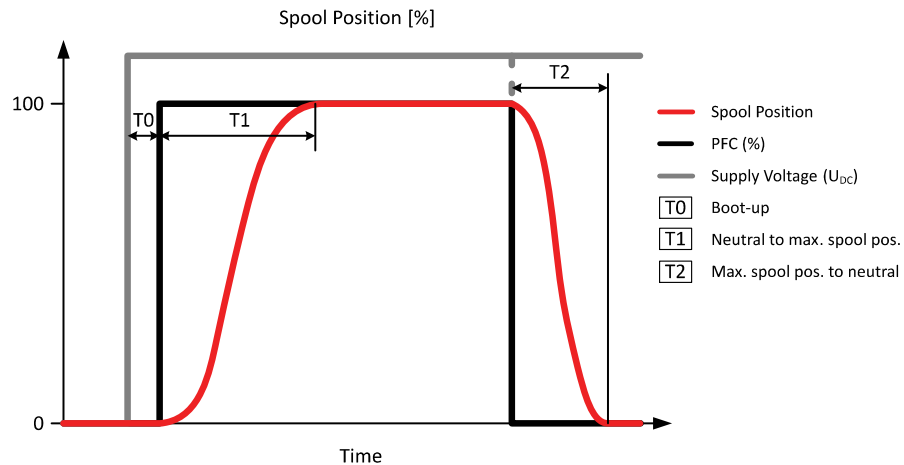
Hysteresis (h)	Rated [%]	1.45%
Steady state ripple at constant command signal	Rated [%]	0.29%

PVE Electro-hydraulic Actuation
PVED-CC Reaction Times
Reaction times

Definition of Step Response

Reaction	Time (nominal)
T0 – Boot-up	440 ms*
T1 – Constant PFC command	177 ms
T2 – Constant PFC command	114 ms

* Including Power-On-Self-Test (POST) and safety sub-system initialization.

The stated values are preliminary values and can be subject to change once an increased statistical basis is achieved.

PVED-CC Part Numbers

Part number	Type	Connector	IP class
11107869	ISOBus	2x4 DEUTSCH	IP67
11107870	ISOBus	2x4 AMP	IP66
11172734	CANOpen	2x4 DEUTSCH	IP67
11169142	CANOpen	2x4 AMP	IP66

PVE Electro-hydraulic Actuation
PVE Series 7
PVEO

The PVEO actuator is a non-proportional ON/OFF control actuator with open-loop spool control primarily used to control simple ON/OFF work functions where a proportional control of speed or oil flow is not a requirement.

PVEO Series 7



- Neutral position or max. spool stroke according to control signal
- 12 V_{DC} or 24 V_{DC} supply voltage
- DEUTSCH, AMP or DIN/Hirschman connectors
- Standard PVE pilot oil pressure of 13.5 bar [196 psi]
- LED only indicating Power ON or Power OFF
- Ramp (-R) or Direction Indication output (-DI) functionality

Functionality principle

PVEO-DI functionality

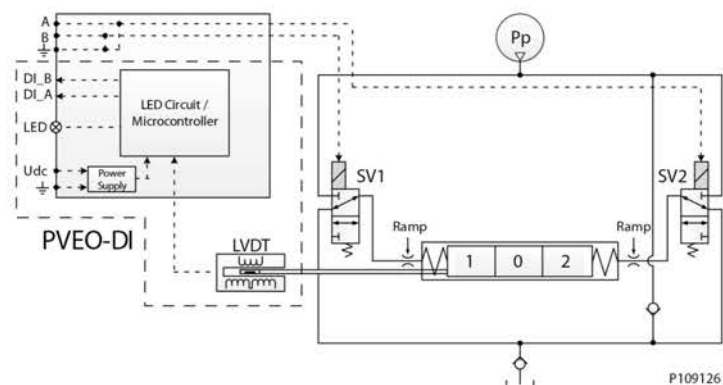

The standard PVEO/PVEO-HP functionality includes the simplest electric circuit of the PVE actuator program, using a fixed 12 V_{DC} or 24 V_{DC} supply voltage or signal voltage and a simple LED circuit to control the LED light indicating Power ON/OFF.

The PVEO-DI variant includes an LVDT spool position monitor and a more advanced electric circuit with an embedded micro-controller and separate power supply to handle the Direction Indication functionality.

Technical Information
PVG 32 Proportional Valve Group
PVE Electro-hydraulic Actuation

An energization of solenoid valve SV1 and a simultaneous de-energization of SV2 will cause the main spool to move to the right direction and vice versa. If both SV1 and SV2 are energized or de-energized simultaneously, the main spool stays locked in its neutral position.

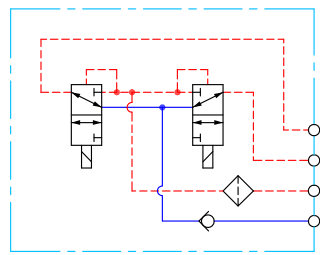
PVEO/PVEO-DI schematic

P109195

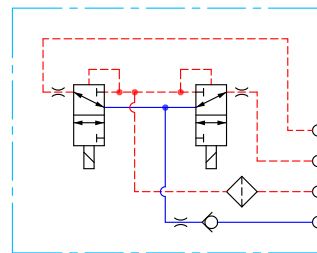
PVEO-R schematic

P109200

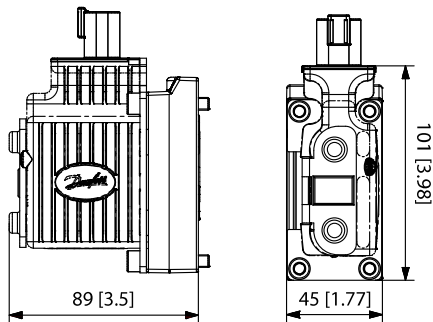
Connector height and weight

DEUTSCH	AMP	DIN	Weight
30 mm [1.2 in]	38 mm [1.5 in]	40 mm [1.6 in]	0.7 kg [1.54 lb]

Technical Information
PVG 32 Proportional Valve Group
PVE Electro-hydraulic Actuation
PVEO Technical Data
Control Specifications

Description	Type	12 V _{DC}	24 V _{DC}
Supply Voltage (U _{DC})	Range	11 to 15 V _{DC}	22 to 30 V _{DC}
	Max. ripple	5%	5%
Current Consumption	Typical	480 mA	250 mA
	Minimum	430 mA	220 mA
	Maximum	950 mA	480 mA

Pilot pressure

Minimum	Nominal	Maximum
10.0 bar [145 psi]	13.5 bar [196 psi]	15.0 bar [218 psi]

Fluid consumption

Neutral/Locked position	Actuating (PVEO-R)	Actuating
0 l/min	0.3 l/min [0.08 US gal/min]	0.9 l/min [0.24 US gal/min]

Technical specification

Parameter	Minimum	Recommended range	Maximum
Fluid viscosity	4 mm ² /s [39 SUS]	12 to 75 mm ² /s [65 to 347 SUS]	460 mm ² /s [2128 SUS]
Fluid cleanliness	18/16/13 (according to ISO 4406)		
Storage temperature	Ambient: -50 to 90°C [-58 to 194°F]		
Operating temperature	Ambient: -40 to 90°C [-40 to 194°F]		

LED characteristic

Color	LED characteristic	Description
Green constant		Power ON

PVEO/PVEO-CI reaction time

Reaction time	A-direction	B-direction
Neutral to full stroke	80 ms	80 ms
Full spool stroke to neutral	80 ms	80 ms

PVE Electro-hydraulic Actuation
PVEO Reaction Times

Reaction times

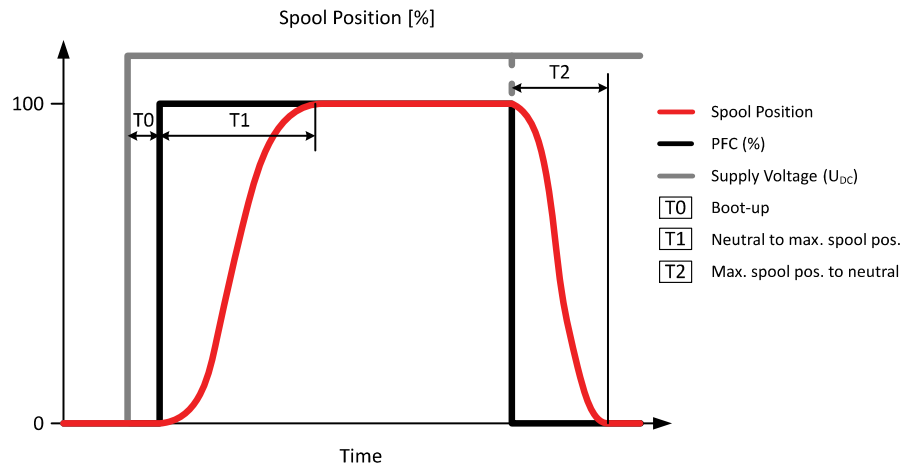
Definition of Step Response

Reaction	PVG 32		PVG 128/256	
	PVEO PVEO-DI	PVEO-R	A port	B port
T0 – Boot-up	0	0	0	0
T1 – Neutral to max. spool stroke @ Power ON/ @ Constant U_{DC}	110 ms	325 ms	375 ms	520 ms
T2 – Max. spool stroke to neutral @ Power OFF/ @ Constant U_{DC}	110 ms	340 ms	350 ms	600 ms

PVEO Part Numbers

Part numbers for PVEO and PVEO-DI

Part number	Type	Connector	Protection Class	Voltage	Interface
11166843	PVEO	1x4 DEU	IP 67	12 V _{DC}	Standard
11166838		1x4 DEU	IP 67	24 V _{DC}	
11166866		1x4 AMP	IP 66	12 V _{DC}	
11166837		1x4 AMP	IP 66	24 V _{DC}	
11166836		1x4 DIN	IP 65	12 V _{DC}	
11166743		1x4 DIN	IP 65	24 V _{DC}	
11168740*	PVEO-DI	2x4 AMP	IP 66	12 V _{DC}	
11166869*		2x4 AMP	IP 66	24 V _{DC}	

PVE Electro-hydraulic Actuation

Part numbers for PVEO and PVEO-DI (continued)

Part number	Type	Connector	Protection Class	Voltage	Interface
11166753	PVEO-R	1x4 DEU	IP 67	12 V _{DC}	Ramp
11166754		1x4 DEU	IP 67	24 V _{DC}	
11166867		1x4 AMP	IP 66	12 V _{DC}	
11166776		1x4 AMP	IP 66	24 V _{DC}	
11166831		1x4 DIN	IP 65	12 V _{DC}	
11166908		1x4 DIN	IP 65	24 V _{DC}	

* Includes Direction Indication special features.

PVE Electro-hydraulic Actuation
PVEO-HP

The PVEO-HP actuator is a non-proportional ON/OFF control actuator with open-loop spool control primarily used to control simple ON/OFF work functions where a proportional control of speed or oil flow is not a requirement.

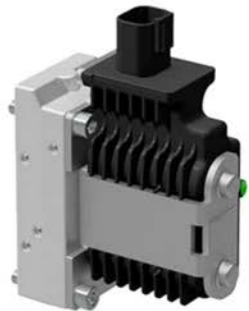
PVEO-HP

All variants are available with following features:

- Neutral position or max. spool stroke according to control signal
- 12 V_{DC} or 24 V_{DC} supply voltage
- DEUTSCH, AMP or DIN/Hirschman connectors
- PVH/PVHC pilot oil pressure of 25 bar [362.6 psi]
- LED only indicating Power ON or Power OFF

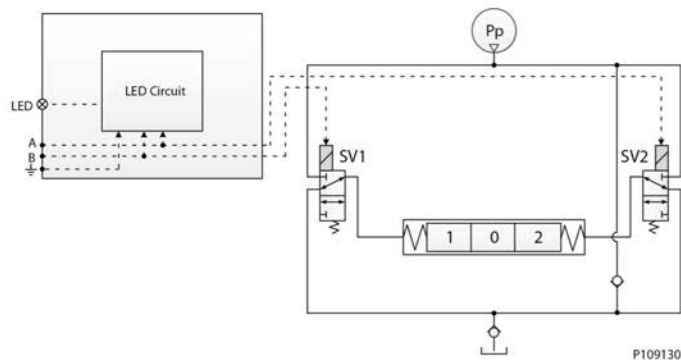
PVEO-HP functionality diagram

The standard PVEO/PVEO-HP functionality includes the simplest electric circuit of the PVE actuator program, using a fixed 12 V_{DC} or 24 V_{DC} supply voltage or signal voltage and a simple LED circuit to control the LED light indicating Power ON/OFF.

An energization of solenoid valve SV1 and a simultaneous de-energization of SV2 will cause the main spool to move to the right direction and vice versa. If both SV1 and SV2 are energized or de-energized simultaneously, the main spool stays locked in its neutral position.

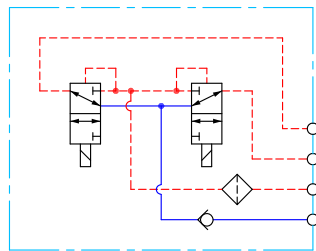
Technical Information
PVG 32 Proportional Valve Group
PVE Electro-hydraulic Actuation
PVEO-HP Schematic

P109195

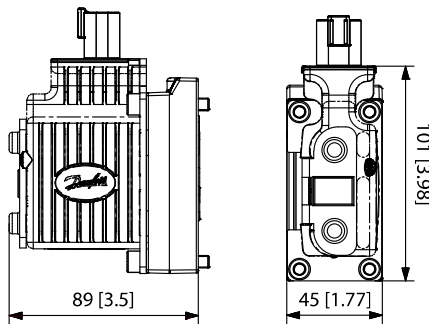
Connector height and weight

DEUTSCH	AMP	DIN	Weight
30 mm [1.2 in]	38 mm [1.5 in]	40 mm [1.6 in]	0.7 kg [1.54 lb]

PVEO-HP Technical Data
Control Specification

Description	Type	12 V _{DC}	24 V _{DC}
Supply Voltage (U _{DC})	Range	11 to 15 V _{DC}	22 to 30 V _{DC}
	Max. ripple	5%	
Current Consumption	Typical	1093 mA	555 mA
	Minimum	660 mA	340 mA
	Maximum	1458 mA	740 mA

Technical data

Pilot pressure	Nominal	25 bar [363 psi]
	Minimum	21 bar [305 psi]
	Maximum	25 bar [363 psi]
Fluid consumption	Neutral	0 l/min [0 US gal/min]
	Locked position	0 l/min [0 US gal/min]
	Actuating	0.9 l/min [0.24 US gal/min]

Technical Information
PVG 32 Proportional Valve Group
PVE Electro-hydraulic Actuation
Technical specification

Parameter	Minimum	Recommended range	Maximum
Fluid temperature	-30°C [-22°F]	30 to 60°C [86 to 140°F]	90° [194°F]
Fluid viscosity	4 mm ² /s [39 SUS]	12 to 75 mm ² /s [65 to 347 SUS]	460 mm ² /s [2128 SUS]
Fluid cleanliness (mechanical activation)	23/19/16 (according to ISO 4406)		
Fluid cleanliness (PVE activation)	18/16/13 (according to ISO 4406)		
Operating temperature	Ambient: -40 to 90°C [-40 to 194°F]		
Max. T-port pressure (static)	25 bar [365 psi]		
Max T-port pressure (intermittent)	40 bar [580 psi]		

LED characteristic

Color	LED characteristic	Description
Green constant		Power ON

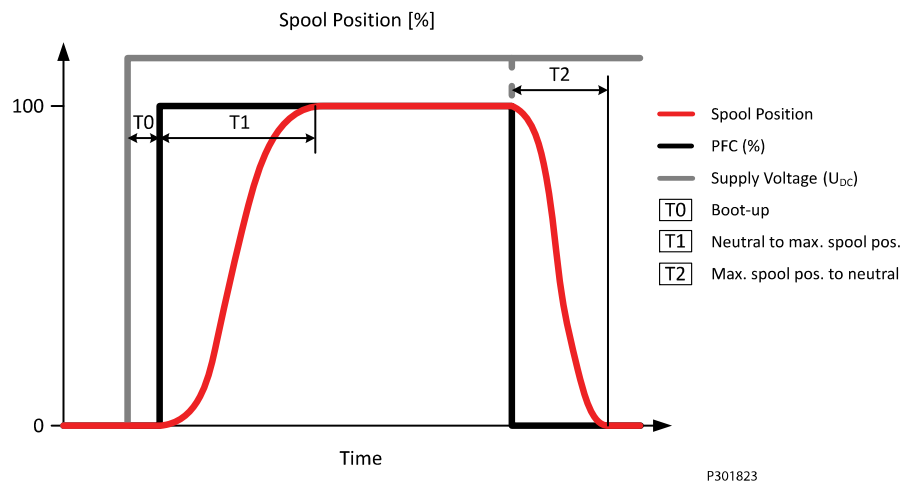
PVEO-HP Reaction Times
Reaction times

Definition of Step Response

Reaction	PVEO-HP
T0 – Boot-up	0
T1 – Neutral to max. spool stroke @ Power ON/@ Constant U_{DC}	90 ms
T2 – Max. spool stroke to neutral @ Power OFF/@ Constant U_{DC}	70 ms

PVE Electro-hydraulic Actuation

PVEO-HP Part Numbers

PVEO-HP Standard Part Numbers

Part number	Connector	IP	U _{DC}	Functionality
11166765	1x4 DEUTSCH	IP 67	12 V _{DC}	Standard
11166766	1x4 DEUTSCH	IP 67	24 V _{DC}	
11166763	1x4 AMP	66	12 V _{DC}	
11187524	1x4 AMP	66	24 V _{DC}	
11187551	1x4 DIN	65	12 V _{DC}	
11187562	1x4 DIN	65	24 V _{DC}	

PVE Electro-hydraulic Actuation
PVEM

The PVEM actuator is a proportional control actuator with closed-loop spool control primarily used to control work functions with medium performance requirements. The PVEM is available in three different performance variants, the standard PVEM, the PVEM-R with ramp and the PVEM-Q with quick reaction.

PVEM

Variants are available with following features:

- 11-32 V_{DC} multi-voltage power supply
- Analog voltage control signal 25–75% of supply voltage
- DIN/Hirschman connectors
- Standard PVE pilot oil pressure of 13.5 bar [196 psi]
- LED indicating error state and passive fault monitoring
- Float (-F), quick Ramp (-R) or Quick reaction functionality (-Q)

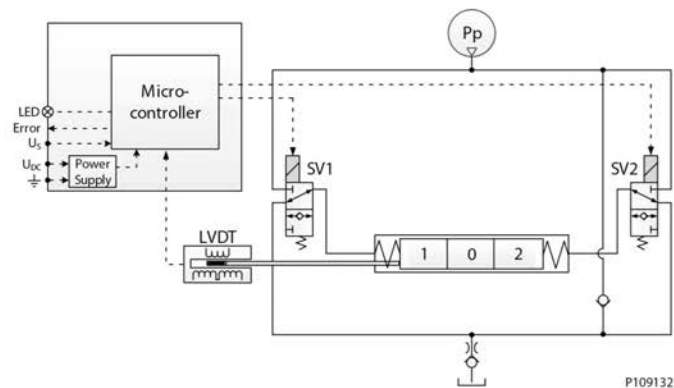
PVEM functionality

The PVE functionality includes an electric circuit with a closed-loop logic. An embedded micro-controller processes the signal voltage and the LVDT feedback signal and regulates the solenoid valves accordingly.

An energization of solenoid valve SV1 and a simultaneous de-energization of SV2 will cause the main spool to move to the right direction and vice versa. If both SV1 and SV2 are energized or de-energized simultaneously, the main spool stays locked in its neutral position.

Technical Information
PVG 32 Proportional Valve Group
PVE Electro-hydraulic Actuation
Schematics

PVEM

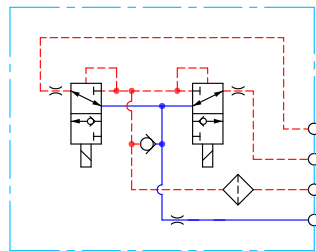

P109196

PVEM-Q

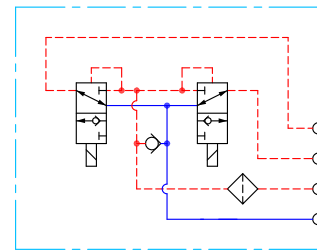

P109201

Dimensions

Dimensions drawing

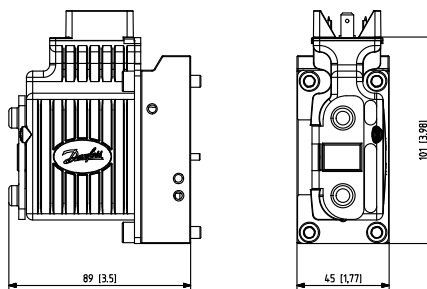

Connector height and weight

DEUTSCH	AMP	DIN	Weight
30 mm [1.2 in]	38 mm [1.5 in]	40 mm [1.6 in]	0.7 kg [1.54 lb]

PVEM Technical Data

Control Specification

Description	Type	Value
Supply Voltage (U_{DC})	Rated Range	11 to 32 V_{DC}
	Max. ripple	5%
Signal Voltage PWM (U_S)	Neutral	$U_S = 0.5 U_{DC} = 50\%$ DUT
	Q: P to A	$U_S = (0.5 \text{ to } 0.25) U_{DC} = 50\%$ to 25% DUT
	Q: P to B	$U_S = (0.5 \text{ to } 0.75) U_{DC} = 50\%$ to 75% DUT
Input Impedance	Rated	12 k Ω
Input Capacitance	Rated	1 nF

Current consumption

Description	@ 12 V_{DC}	@ 24 V_{DC}
PWM Frequency (U_S) recommended	> 200 Hz	> 200 Hz
Current Consumption	690 mA	350 mA

Technical Information
PVG 32 Proportional Valve Group
PVE Electro-hydraulic Actuation
Pilot pressure

Minimum	Nominal	Maximum
10.0 bar [145 psi]	13.5 bar [196 psi]	15.0 bar [218 psi]





Fluid consumption

Neutral/Locked position	Actuating (PVEM-R)	Actuating (PVEM-Q)	Actuating
0 l/min	0.3 l/min	1.0 l/min [0.26 US gal/min][0.08 US gal/min]	0.5 l/min [0.13 US gal/min]

Technical specification

Parameter	Minimum	Recommended range	Maximum
Fluid temperature	-30°C [-22°F]	30 to 60°C [86 to 140°F]	90° [194°F]
Fluid viscosity	4 mm ² /s [39 SUS]	12 to 75 mm ² /s [65 to 347 SUS]	460 mm ² /s [2128 SUS]
Fluid cleanliness (mechanical activation)	23/19/16 (according to ISO 4406)		
Fluid cleanliness (PVE activation)	18/16/13 (according to ISO 4406)		
Operating temperature	Ambient: -40 to 90°C [-40 to 194°F]		
Max. T-port pressure static / intermittent	20 / 40 bar [365 / 580 psi]		

LED characteristic

Color	LED characteristic	Description
Green constant		No error – Actuating
Green flashing @ 1.5 Hz		Neutral – Power save
Red constant		Internal error
Red flashing @ 1.5 Hz		External or Float error

PVE Electro-hydraulic Actuation
PVEM Reaction Times

Reaction times

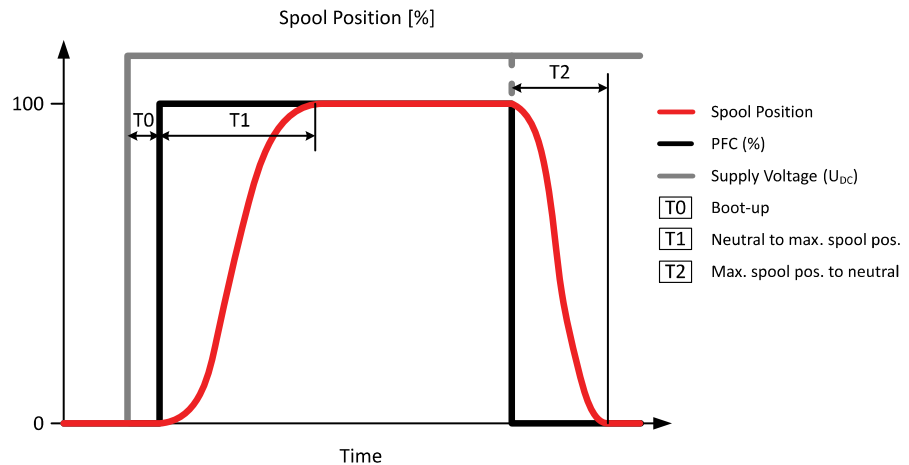
Definition of Step Response

Reaction	PVEM-R	PVEM/PVEM-FLB	PVEM-Q
T0 – Boot-up	15 ms	15 ms	15 ms
T1 – Neutral to max. spool stroke @ Power ON	325 ms	225 ms	125 ms
T2 – Max. spool stroke to neutral @ Power OFF	110 ms	110 ms	110 ms
T1 – Neutral to max. spool stroke @ Constant U_{DC}	310 ms	210 ms	110 ms
T2 – Max. spool stroke to neutral @ Constant U_{DC}	90 ms	90 ms	90 ms

PVE Hysteresis and Ripple

PVE hysteresis overview

PVE type	PVEP, PVES	PVEA	PVEH	PVEM
Hysteresis (h)	<0.5 %	2%	4%	15%
Steady state ripple @constant Us	0.2 mm	0.3 mm	0.2 mm	0.0 mm

PVEM part numbers

Part numbers for PVEM variants with Passive Fault Monitoring; IP rating IP65 and DIN 1x4 connector.

Part numbers for PVEM variants

Part number	Type	Functionality
11166829	PVEM	Standard
11166852	PVEM-FLB	Float B-port
11166845	PVEM-R	Ramp
11166853	PVEM-Q	Quick Reaction

PVE Electro-hydraulic Actuation
PVEA

The PVEA actuator is a proportional control actuator with a closed-loop spool control primarily used to control work functions with above medium performance requirements.

PVEA

- 11-32 V_{DC} multi-voltage power supply
- Analog voltage control signal 25–75% of supply voltage
- Standard PVE pilot oil pressure of 13.5 bar [196 psi]
- DEUTSCH or AMP connectors
- LED indicating error state and active or passive fault monitoring
- Direction Indication output (-DI) or Neutral Power-Off (-NP) functionality

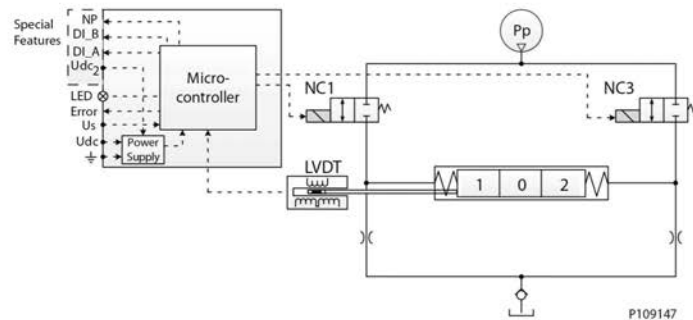
PVEA-DI functionality
PVEA-DI functionality

The PVE functionality includes an electric circuit with a closed-loop logic. An embedded micro-controller processes the signal voltage and the LVDT feedback signal and regulates the solenoid valves accordingly.

A continuous modulation of solenoid valve NC1 and a simultaneous de-energization of NC3 causes the main spool to move to the right direction and vice versa. When the main spool is stroked to the far right, a simultaneous modulation of both NC1 and NC3 balances the main spool in its stroked position. The main spool oscillates in its stroked position at a frequency corresponding to the modulation frequency. When both NC1 and NC3 are de-energized, the main spool moves back to its neutral position by means of the main spool neutral spring and the hydraulic principle.

PVE Electro-hydraulic Actuation
PVEA Technical Data
Control Specification

Description	Type	Value
Supply Voltage (U_{DC})	Rated Range	11 to 32 V _{DC}
	Max. ripple	5%
Signal Voltage PWM (U_S)	Neutral	$U_S = 0.5 U_{DC} = 50\%$ DUT
	Q: P to A	$U_S = (0.5 \text{ to } 0.25) U_{DC} = 50\%$ to 25% DUT
	Q: P to B	$U_S = (0.5 \text{ to } 0.75) U_{DC} = 50\%$ to 75% DUT
Input Impedance	Rated	12 k Ω
Input Capacitance	Rated	1 nF

Current consumption

Description	@ 12 V _{DC}	@ 24 V _{DC}
PWM Frequency (U_S) recommended	> 1000 Hz	> 1000 Hz
Current Consumption	290 mA	150 mA

Pilot pressure

Minimum	Nominal	Maximum
10.0 bar [145 psi]	13.5 bar [196 psi]	15.0 bar [218 psi]



Fluid consumption

Neutral	Locked position	Actuating
0 l/min	0 l/min	1.0 l/min [0.26 US gal/min]

Technical specification

Parameter	Minimum	Recommended range	Maximum
Fluid viscosity	4 mm ² /s [39 SUS]	12 to 75 mm ² /s [65 to 347 SUS]	460 mm ² /s [2128 SUS]
Fluid cleanliness	18/16/13 (according to ISO 4406)		
Storage temperature	Ambient: -50 to 90°C [-58 to 194°F]		
Operating temperature	Ambient: -40 to 90°C [-40 to 194°F]		
Max. T-port pressure static / intermittent	25 / 40 bar [365 / 580 psi]		

LED characteristic

Color	LED characteristic	Description
Green constant		No error – Actuating
Green flashing @ 1.5 Hz		Neutral – Power save
Red constant		Internal error
Red flashing @ 1.5 Hz		External or Float error

PVE Electro-hydraulic Actuation
PVEA Reaction Times

Reaction times

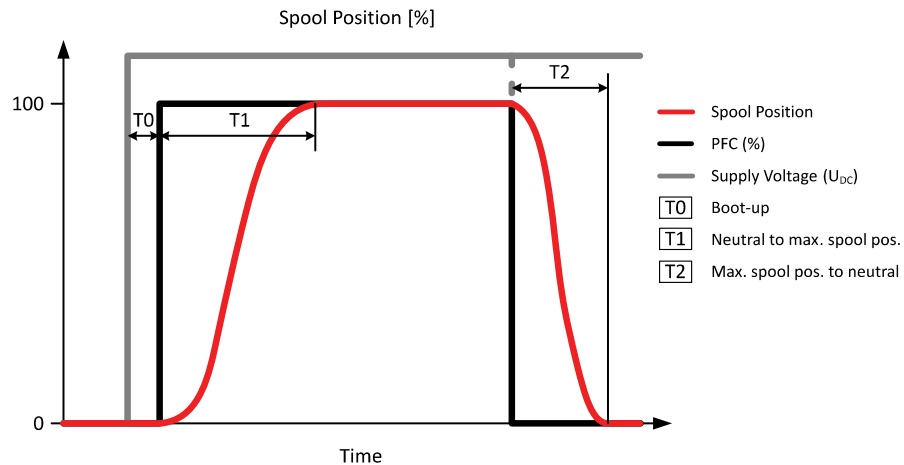

P301823

Reaction	PVG 32 (PVEA)
T0 – Boot-up [ms]	50 ms
T1 – Neutral to max. spool stroke @ Power ON	355 ms
T2 – Max. spool stroke to neutral @ Power OFF	260 ms
T1 – Neutral to max. spool stroke @ Constant U _{DC}	305 ms
T2 – Max. spool stroke to neutral @ Constant U _{DC}	210 ms

PVE Hysteresis and Ripple

PVE hysteresis overview

PVE type	PVEP, PVES	PVEA	PVEH	PVEM
Hysteresis (h)	<0.5 %	2%	4%	15%
Steady state ripple @constant U _s	0.2 mm	0.3 mm	0.2 mm	0.0 mm

PVEA part numbers

Part numbers for PVEA variants with Standard Functionality.

Part numbers for PVEA variants

Part number	Type	Connector	IP rating	Fault Monitoring
11177346	PVEA	1x4 DEU	IP67	Passive
11177347	PVEA		IP67	Active
11177353	PVEA	1x4 AMP	IP66	Passive
11177348	PVEA		IP66	Active
11177345	PVEA-NP ¹⁾	1x6 DEU	IP67	Passive
11177357	PVEA-DI ²⁾	2x4 DEU	IP67	Active

PVE Electro-hydraulic Actuation

Part numbers for PVEA variants (continued)

Part number	Type	Connector	IP rating	Fault Monitoring
11177356	PVEA-DI ²⁾	2x4 AMP	IP66	Passive
11177355	PVEA-DI ²⁾		IP66	Active

¹⁾ Neutral Power-Off special features.

²⁾ Direction Indication special features.

PVE Electro-hydraulic Actuation
PVEH

The PVEH actuator is a proportional control actuator with closed-loop spool control primarily used to control work functions with high performance requirements.

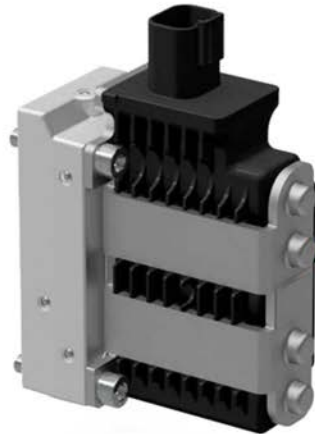
PVEH

- 11-32 V_{DC} multi-voltage power supply
- Analog voltage control signal 25–75% of supply voltage
- Standard PVE pilot oil pressure of 13.5 bar [196 psi]
- DEUTSCH, AMP or DIN/Hirschman connectors
- LED indicating error state and active or passive fault monitoring
- Float (-F), Direction Indication output (-DI), Neutral Power-Off (-NP), Spool Position output (-SP) or 0-10 V_{DC} control signal (-U) functionality

PVEH functionality

The PVE functionality includes an electric circuit with a closed-loop logic. An embedded micro-controller processes the signal voltage and the LVDT feedback signal and regulates the solenoid valves accordingly.

A continuous modulation of solenoid valves NC1 and NO4 together with a simultaneous energization of NO2 and de-energization of NC3 causes the main spool to move to the right direction and vice versa. When the main spool is stroked to the far right, a simultaneous energization of both NO2 and NO4 and de-energization of both NC1 and NC3 balances the main spool in its stroked position. An emergency stop activated when the spool is stroked will cause all solenoid valves to de-energize causing the main spool to move back to its neutral position by means of the main spool neutral spring and the hydraulic principle.

PVEH Technical Data
Control Specification

Description	Type	Value
Supply Voltage (U _{DC})	Rated Range	11 to 32 V _{DC}
	Max. ripple	5%
Signal Voltage PWM (U _S)	Neutral	U _S = 0.5 U _{DC} = 50% DUT
	Q: P to A	U _S = (0.5 to 0.25) U _{DC} = 50% to 25% DUT
	Q: P to B	U _S = (0.5 to 0.75) U _{DC} = 50% to 75% DUT

Technical Information
PVG 32 Proportional Valve Group
PVE Electro-hydraulic Actuation
Control Specification (continued)

Description	Type	Value
Input Impedance	Rated	12 kΩ
Input Capacitance	Rated	1 nF

Current consumption

Description	@ 12 V _{DC}	@ 24 V _{DC}
PWM Frequency (U _S) recommended	> 1000 Hz	> 1000 Hz
Current Consumption	540 mA	270 mA
Max. DI Current	200 mA	200 mA

Pilot pressure

Minimum	Nominal	Maximum
10.0 bar [145 psi]	13.5 bar [196 psi]	15.0 bar [218 psi]





Fluid consumption

Neutral	Locked position	Actuating
0.0 l/min	0.0 l/min	0.7 l/min [0.18 US gal/min]

Technical specification

Parameter	Minimum	Recommended range	Maximum
Fluid viscosity	4 mm ² /s [39 SUS]	12 to 75 mm ² /s [65 to 347 SUS]	460 mm ² /s [2128 SUS]
Fluid cleanliness	18/16/13 (according to ISO 4406)		
Storage temperature	Ambient: -50 to 90°C [-58 to 194°F]		
Operating temperature	Ambient: -40 to 90°C [-40 to 194°F]		
Max. T-port pressure static / intermittent	25 / 40 bar [365 / 580 psi]		

LED Characteristic

Color	LED Characteristic	Description
Green constant		No error – Actuating
Green flashing @ 1.5 Hz		Neutral – Power save
Red constant		Internal error
Red flashing @ 1.5 Hz		External or Float error
Yellow		Disable mode

PVE Electro-hydraulic Actuation
PVEH Reaction Times

Reaction times

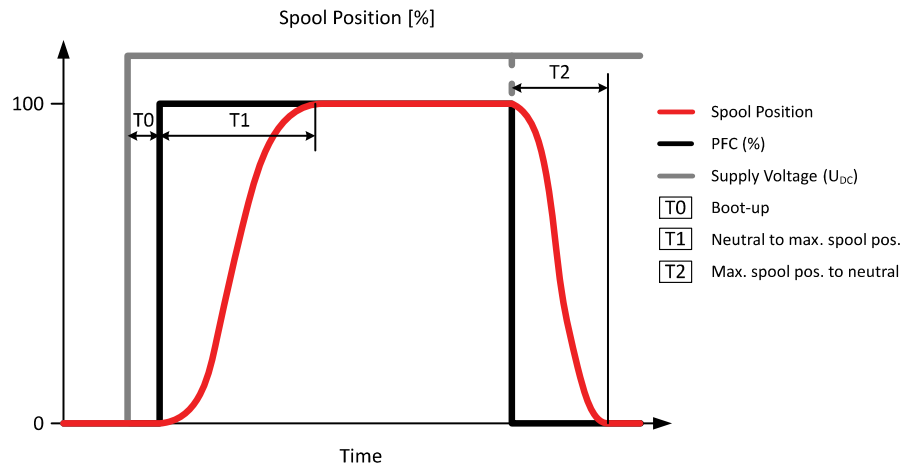

P301823

Reaction	PVG 32	PVG 128/256
T ₀ – Boot-up [ms]	40 ms	40 ms
T ₁ – Neutral to max. spool stroke @ Power ON [ms]	155 ms	400 ms
T ₂ – Max. spool stroke to neutral @ Power OFF [ms]	130 ms	300 ms
T ₁ – Neutral to max. spool stroke @ Constant U _{DC} [ms]	115 ms	380 ms
T ₂ – Max. spool stroke to neutral @ Constant U _{DC} [ms]	90 ms	270 ms

PVE Hysteresis and Ripple

PVE hysteresis overview

PVE type	PVEP, PVES	PVEA	PVEH	PVEM
Hysteresis (h)	<0.5 %	2%	4%	15%
Steady state ripple @constant U _s	0.2 mm	0.3 mm	0.2 mm	0.0 mm

PVEH Part Numbers

Part numbers for PVEH variants

Part number	Type	Connector	IP class	Fault Monitoring	Functionality
11166732	PVEH	1x4 DEUTSCH	IP67	Passive	Standard
11166775	PVEH	1x4 DEUTSCH	IP67	Active	
11166825	PVEH	1x4 AMP	IP66	Passive	
11166818	PVEH	1x4 AMP	IP66	Active	
11166824	PVEH	1x4 DIN	IP65	Passive	
11166817	PVEH	1x4 DIN	IP65	Active	
11166832 ¹⁾	PVEH-U	1x4 AMP	IP66	Passive	Fixed U _s 0-10 V _{DC}
11166821 ¹⁾	PVEH-U	1x4 AMP	IP66	Active	
11166770 ¹⁾	PVEH-U	1x4 DIN	IP65	Passive	
11166772 ¹⁾	PVEH-U	1x4 DIN	IP65	Active	

PVE Electro-hydraulic Actuation
Part numbers for PVEH variants (continued)

Part number	Type	Connector	IP class	Fault Monitoring	Functionality
11166840	PVEH-FLB	1x4 DEUTSCH	IP67	Passive	Float B-port
11166742	PVEH-FLB	1x4 DEUTSCH	IP67	Active	
11166839	PVEH-FLB	1x4 DIN	IP65	Active	
11166841 ²⁾	PVEH-FLA	1x6 DEUTSCH	IP67	Active	Float A-port
11168738 ²⁾	PVEH-FLA	1x6 AMP	IP66	Passive	
11168739 ²⁾	PVEH-FLA	1x6 AMP	IP66	Active	
11166773 ³⁾	PVEH-SP	1x6 DEUTSCH	IP67	Active	Standard
11166750 ⁴⁾	PVEH-NP	1x6 DEUTSCH	IP67	Fast active	
11166835 ⁵⁾	PVEH-DI	2x4 DEUTSCH	IP67	Active	
11166820 ⁵⁾	PVEH-DI	2x4 AMP	IP66	Passive	
11166819 ⁵⁾	PVEH-DI	2x4 AMP	IP66	Active	

¹⁾ Includes **Disable Mode** special feature

²⁾ Includes **Dedicated Float Pin** (UF) special feature

³⁾ Includes **Spool Position** special feature

⁴⁾ Includes **Neutral Power-OFF** special feature

⁵⁾ Includes **Direction Indication** special feature

PVE Electro-hydraulic Actuation
PVES

The PVES actuator is a proportional control actuator with closed-loop spool control primarily used to control work functions with very high performance requirements.

PVES

- 11-32 V_{DC} multi-voltage power supply
- Analog voltage control signal 25–75% of supply voltage
- Standard PVE pilot oil pressure of 13.5 bar [196 psi]
- DEUTSCH, AMP or DIN/Hirschman connectors
- LED indicating error state and active or passive fault monitoring
- Spool Position output (-SP) or 0-10 V_{DC} control signal (-U) functionality or PWM (-P) variant

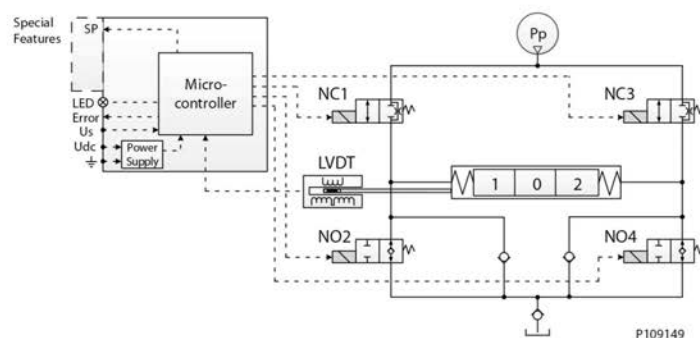
PVES functionality
PVES functionality

The PVE functionality includes an electric circuit with a closed-loop logic. An embedded micro-controller processes the signal voltage and the LVDT feedback signal and regulates the solenoid valves accordingly.

A continuous modulation of solenoid valves NC1 and NO4 together with a simultaneous energization of NO2 and de-energization of NC3 causes the main spool to move to the right direction and vice versa.

When the main spool is stroked to the far right, a simultaneous energization of both NO2 and NO4 and de-energization of both NC1 and NC3 balances the main spool in its stroked position. An emergency stop

Technical Information
PVG 32 Proportional Valve Group
PVE Electro-hydraulic Actuation

activated when the spool is stroked will cause all solenoid valves to de-energize causing the main spool to move back to its neutral position by means of the main spool neutral spring and the hydraulic principle.

PVES Technical Data
Control Specification

Description	Type	Value
Supply Voltage (U_{DC})	Rated Range	11 to 32 V _{DC}
	Max. ripple	5%
Signal Voltage PWM (U_S)	Neutral	$U_S = 0.5 U_{DC} = 50\%$ DUT
	Q: P to A	$U_S = (0.5 \text{ to } 0.25) U_{DC} = 50\%$ to 25% DUT
	Q: P to B	$U_S = (0.5 \text{ to } 0.75) U_{DC} = 50\%$ to 75% DUT
Input Impedance	Rated	12 k Ω
Input Capacitance	Rated	1 nF

Current consumption

Description	@ 12 V _{DC}	@ 24 V _{DC}
PWM Frequency (U_S) recommended	> 1000 Hz	> 1000 Hz
Current Consumption	560 mA	280 mA

Pilot pressure

Minimum	Nominal	Maximum
10.0 bar [145 psi]	13.5 bar [196 psi]	15.0 bar [218 psi]



Fluid consumption

Neutral	Locked position	Actuating
0.03 l/min [0.106 US gal/min]	0.01 l/min [0.026 US gal/min]	0.8 l/min [0.21 US gal/min]



Technical specification

Parameter	Minimum	Recommended range	Maximum
Fluid viscosity	4 mm ² /s [39 SUS]	12 to 75 mm ² /s [65 to 347 SUS]	460 mm ² /s [2128 SUS]
Fluid cleanliness	18/16/13 (according to ISO 4406)		
Storage temperature	Ambient: -50 to 90°C [-58 to 194°F]		
Operating temperature	Ambient: -40 to 90°C [-40 to 194°F]		
Max. T-port pressure static / intermittent	25 / 40 bar 265 / 580 psi		

LED Characteristic

Color	LED Characteristic	Description
Green constant		No error – Actuating
Green flashing @ 1.5 Hz		Neutral – Power save
Red constant		Internal error

PVE Electro-hydraulic Actuation
LED Characteristic (continued)

Color	LED Characteristic	Description
Red flashing @ 1.5 Hz		External or Float error
Yellow		Disable mode

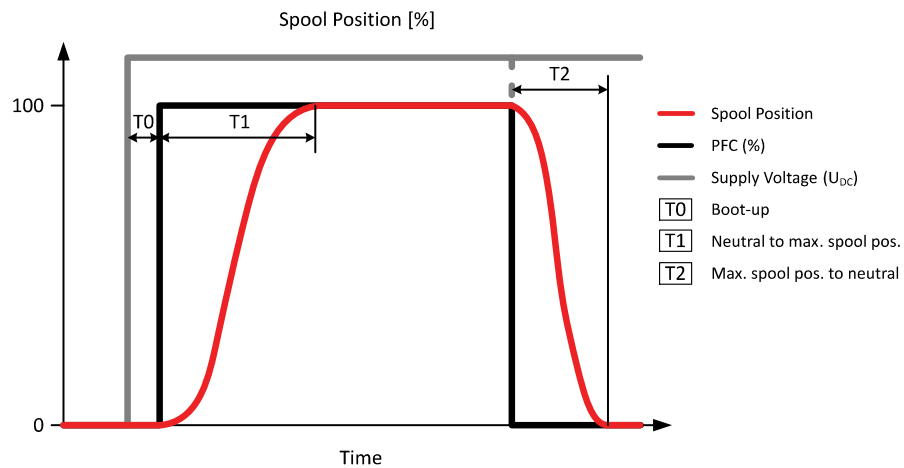
PVES Reaction Times
Reaction times

Reaction	PVES
T ₀ – Boot-up [ms]	45 ms
T ₁ – Neutral to max. spool stroke @ Power ON	170 ms
T ₂ – Max. spool stroke to neutral @ Power OFF	135 ms
T ₁ – Neutral to max. spool stroke @ Constant U _{DC}	125 ms
T ₂ – Max. spool stroke to neutral @ Constant U _{DC}	90 ms

PVE Hysteresis and Ripple
PVE hysteresis overview

PVE type	PVEP, PVES	PVEA	PVEH	PVEM
Hysteresis (h)	<0.5 %	2%	4%	15%
Steady state ripple @constant U _s	0.2 mm	0.3 mm	0.2 mm	0.0 mm

PVE Electro-hydraulic Actuation
PVES Part Numbers
Part numbers for PVES variants

Part number	Type	Connector	IP	Fault Monitoring	Functionality
11166748	PVES	1x4 DEUTSCH	IP67	Passive	Standard
11166864	PVES	1x4 DEUTSCH	IP67	Active	
11166859	PVES	1x4 AMP	IP66	Passive	
11166858	PVES	1x4 AMP	IP66	Active	
11166849	PVES	1x4 DIN	IP65	Passive	
11166857	PVES	1x4 DIN	IP65	Active	
11166745 ¹⁾	PVES-U	1x4 DEUTSCH	IP67	Passive	Fixed U _S 0-10 V _{DC}
11166747 ¹⁾	PVES-U	1x4 AMP	IP66	Active	
11166752 ²⁾	PVES-SP	1x6 DEUTSCH	IP67	Passive	Standard
11314593 ³⁾	PVES-P	1x6 DEUTSCH	IP67	Passive	
11314581 ³⁾	PVES-P	1x6 DEUTSCH	IP67	Active	

¹⁾ Includes **Disable Mode** special feature

²⁾ Includes **Spool Position** special feature

³⁾ Includes **Pulse Width Modulation** special feature

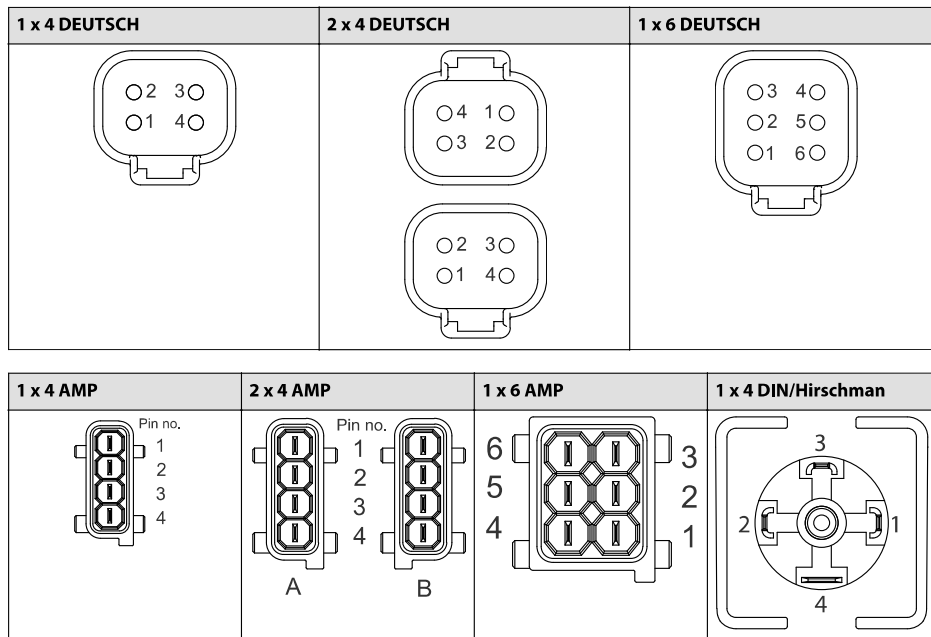
Technical Information
PVG 32 Proportional Valve Group
PVE Electro-hydraulic Actuation
Connector Overview

PVEO-DI 4-pin AMP Connector

Pinout	Pin 1	Pin 2	Pin 3	Pin 4
2x4 AMP (A)	U_{DC_A}	U_{DC_B}	GND	GND
2x4 AMP (B)	DI-B	DI-A	GND	U_{DC2}

PVEM 4-pin DIN Connector

Pinout	Pin 1	Pin 2	Pin 3	Pin 4
1x4 DIN	U_{DC}	U_S	Error	GND

PVEO, PVEO-R and PVEO-HP 4-pin Connector

Pinout	Pin 1	Pin 2	Pin 3	Pin 4
1x4 AMP	U_{DC_A}	U_{DC_B}	GND	GND
1x4 DEUTSCH	U_{DC_A}	GND	GND	U_{DC_B}
1x4 DIN	U_{DC_A}	U_{DC_B}	-	GND

PVEA/PVEH/PVES

Pinout	Pin 1	Pin 2	Pin 3	Pin 4
1x4 AMP	U_S	U_{DC}	GND	Error
1x4 DEUTSCH	U_S	Error	GND	U_{DC}
1x4 DIN	U_{DC}	U_S	Error	GND

Technical Information
PVG 32 Proportional Valve Group
PVE Electro-hydraulic Actuation
PVEA-DI and PVEH-DI 4-pin Connector

Pinout	Pin 1	Pin 2	Pin 3	Pin 4
2x4 AMP (A)	U _S	U _{DC}	GND	Error
2x4 AMP (B)	DI-B	DI-A	GND	U _{DC2}
2x4 DEUTSCH (A)	U _S	Error	GND	U _{DC}
2x4 DEUTSCH (B)	U _{DC2}	GND	DI-A	DI-B

PVEH-FLA 6-pin Connector

Pinout	Pin 1	Pin 2	Pin 3	Pin 4	Pin 5	Pin 6
1x6 AMP	U _S	U _{DC}	GND	Error	Float	-
1x6 DEUTSCH	U _S	Error	-	SP	GND	U _{DC}

PVEH-SP and PVES-SP 6-pin Connector

Pinout	Pin 1	Pin 2	Pin 3	Pin 4	Pin 5	Pin 6
1x6 DEUTSCH	U _S	Error	-	SP	GND	U _{DC}

PVES-P 6-pin Connector

Pinout	Pin 1	Pin 2	Pin 3	Pin 4	Pin 5	Pin 6
1x6 DEUTSCH	PWM_A	Error	PWM_B	-	GND	U _{DC}

PVE Electro-hydraulic Actuation
Extension plates for PVE Series 7

The PVE Series 7 Extension Plates are intended for use in case of conflict with external piping, or if a PVBD (diverter) is mounted on the PVB, when replacing a PVE Series 4 with a PVE Series 7.

The Extension Plates are compatible with all versions of the PVE Series 7 and come in two different sizes with different purposes:

- A) 17 mm [0.67] – Moves the PVE series 7 further away from the PVB module so the total length of the plate and the PVE Series 7 is similar to the length of a PVE Series 4
- B) 44 mm [1.73] – Moves the PVE series 7 further away from the PVB module so the distance between the PVE Series 7 connector and the PVB module is similar to the distance between connector and PVB module when using a PVE Series 4

If you are using a PVE Series 7 with 2x4 DEUTSCH connector the distance will be 12,9 mm smaller between the PVB module and the connector, than in the case of using a PVE Series 4.

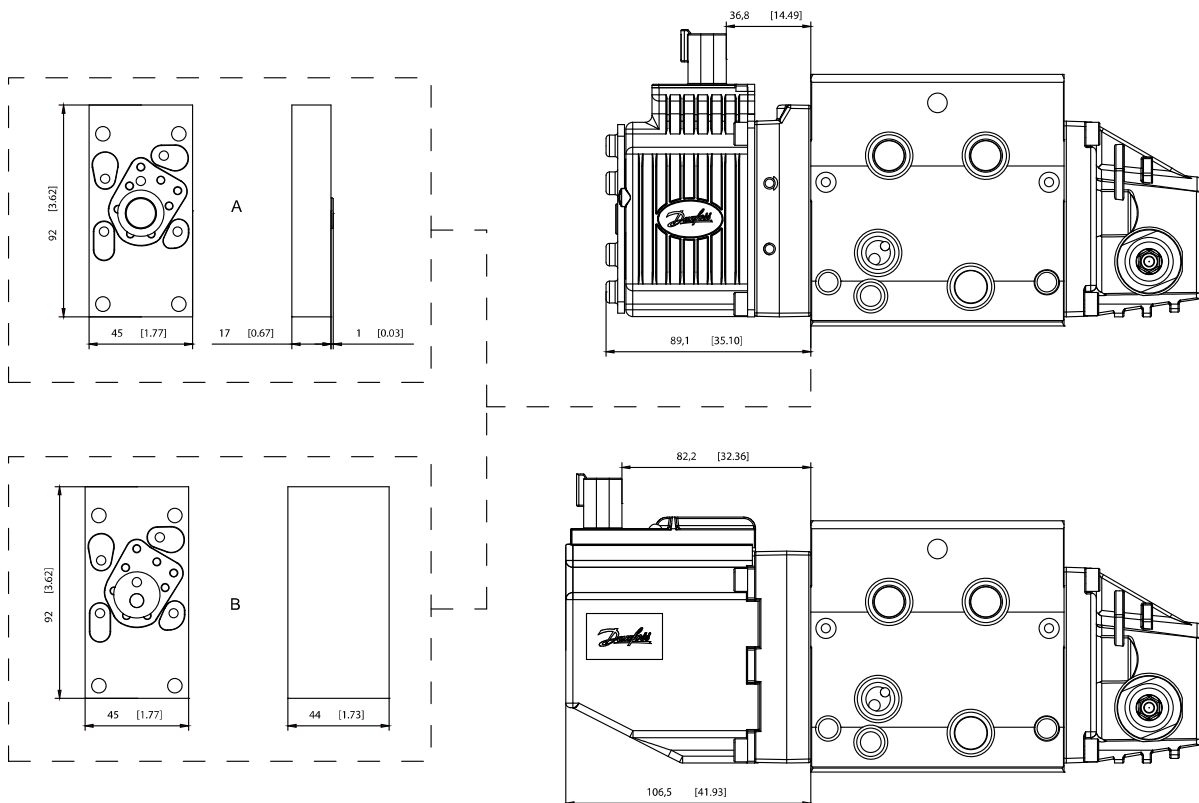
PVE Series 7 extension plates

Part number	Description	Letter
11189080	17 mm aluminum block + seal kit + screws	A
11189081	44 mm aluminum block + seal kit + screws	B

Fault Monitoring and Reaction

All proportional control PVG 32 actuators feature:

- Integrated fault monitoring
- Detecting spool stroke inconsistencies
- Detecting internal hardware defects
- Detecting demand signal inconsistencies
- Fault reaction depending on the type of fault monitoring
 - Generic
 - Specific

Passive fault monitoring

Passive fault monitoring does not disable the solenoid valves when an error is detected. It will continue to operate despite that an error was detected. When the error no longer is registered the passive fault monitoring will “forget” the error and continue as if the error was never there.

With a passive fault monitoring the following conditions will happen when an error is detected/occurs:

- The LED light will switch from green to red and the error pin output will go high
- The solenoid valves will continue operating at the set point given at the time of the error
 - Only exception is if the error is caused by the supply voltage (U_{DC}) being either above or below the allowed range or if the temperature measured on the internal electronics board is higher than allowed. In these cases, the solenoid valves will be disabled.













Generic Fault Reaction

All PVE actuators with fault monitoring are triggered by the following main events:

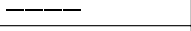
Control Signal Monitoring	The Control signal voltage (U_s) is continuously monitored. The permissible range is between 15% and 85% of the supply voltage (U_{DC}). Outside this range the PVE will switch into an error state. A disconnected U_s pin (floating) is recognized as a neutral set point.
Transducer/LVDT Supervision	The internal LVDT wires are monitored. If the signals are interrupted or short-circuited, the PVE will switch into an error state.
Supervision of Spool Position	The actual position must always correspond to the demanded position (U_s). If the actual spool position is further out from neutral than the demanded spool position or in opposite direction, the PVE will switch into an error state. Spool position closer to neutral and in same direction will not cause an error state – the situation is considered <i>in control</i> .
Temperature Monitoring	When the temperature is too high the PVE LED will light constant red and solenoid valves will be disabled.

Fault Monitoring and Reaction
Fault Reaction Overview

All entries have an Auto Recovery feature unless marked otherwise.

Description	Monitoring	LED	Solenoid valves	Error pin output	Fault reaction time	
					PVEM/H/S	PVEA
Spool not at setpoint	Active*		Disabled	High	500	750
	Passive		-	High	250	750
Unable to reach float position	Active*		Disabled	High	1000	1000
	Passive		-	High	1000	1000
U dc > max.	Active		Disabled	-	-	-
	Passive		Disabled	-	-	-
U dc < min.	Active		Disabled	-	-	-
	Passive		Disabled	-	-	-
Us out of range	Active*		Disabled	High	500	750
	Passive		-	High	250	750
LVDT error	Active*		Disabled	High	500	750
	Passive		-	High	250	750
Temp > max.	Active*		Disabled	High	250	750
	Passive		Disabled	High	250	750

* Does not have Auto Recovery

Error Pin Specification

All proportional control PVE Series 7 actuators feature an error pin, indicating when an error is detected/occurs, according to the Fault Reaction Overview table. The specifications of the error pin is shown below.

Description	No error	Error
Output state	Low	High
Output voltage	<2 Vdc	~Udc
Output current (Sinking)	Max. 100 mA	

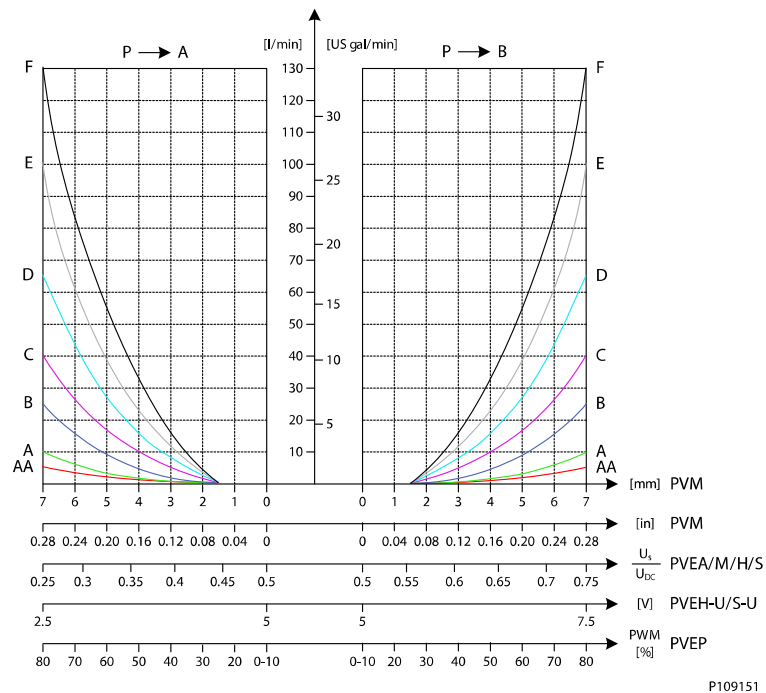
Technical Information
PVG 32 Proportional Valve Group
Functionality Overview
Progressive oil flow characteristics depending on spool type

PWM Voltage Control

The PVEM/PVEA/PVEH/PVES actuator variants can be controlled by a PWM controlled signal voltage (U_s) proportional to the supply voltage (U_{dc}).

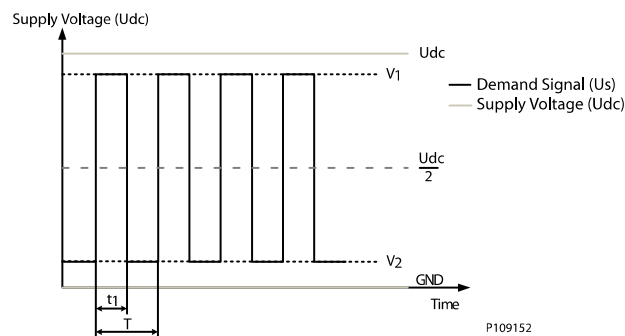
The V_1 and V_2 must be symmetrical around $U_{dc}/2$ and V_1 must be equal to or less than U_{dc} .



Technical Information
PVG 32 Proportional Valve Group
Functionality Overview
Float A-Port (-FLA)

The Float A-Port functionality enables the proportional PVEH-FLA actuator variants to enter the main spool into a float position. The PVE actuators with Float A-Port functionality is compatible with the dedicated main spools with electronic float in A-port.

PVE Type	PVBS Type	Standard Flow Control	Float Control
PVEH-FLA (1x6 pin)	Deadband 0.8 mm	$U_s = (0.25 \rightarrow 0.75) \cdot U_{dc}$	U dc to dedicated float pin (UF)
	Max. A-port flow 5.5 mm		

Float B-Port (-FLB)

The Float B-Port functionality enables the proportional PVEM-FLB/PVEH-FLB actuator variants to enter the main spool into a float position. The PVE actuators with Float B-Port functionality is compatible with the dedicated main spools with electronic float in B-port.

PVE Type	PVBS Type	Standard FC	Float Control
PVEM-FLB (1x4 pin)	Deadband 1.5 mm Max. B-port flow 4.8 mm	$U_s = (0.35 \rightarrow 0.65) \cdot U_{DC}$	$U_s = 0.75 \cdot U_{DC}$
PVEH-FLB (1x4 pin)			

Float in B-port functionality

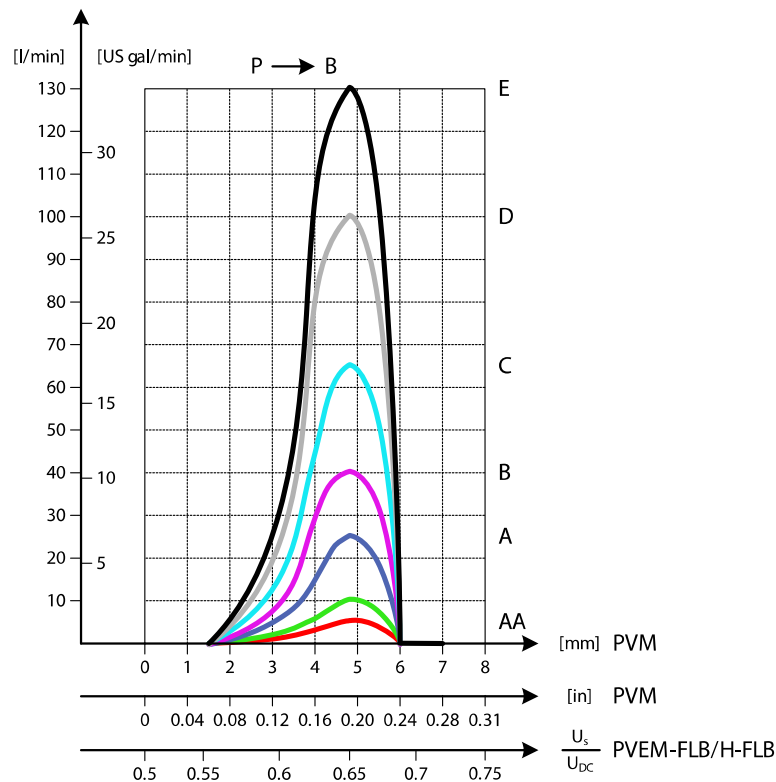

P109155

Functionality Overview

PVE Power Save

All proportional actuator variants feature a Power Save mode, de-energizing the solenoid valve bridge. The Power Save mode is entered when the signal voltage (Us) and the LVDT spool position has been in neutral for 750 ms. As soon as the signal voltage (Us) or the LVDT spool position is out of neutral the PVE will leave its Power Save mode and re-energize the solenoid valve bridge as usual.

The Power Save mode results in increased power efficiency by reducing the current consumption of the PVE actuators in neutral position. The Power Save mode has no effect on the performance of the PVE actuator.

Special Features
Direction Indication (-DI)

The PVEO-DI/PVEA-DI/PVEH-DI actuator variants feature an integrated Direction Indication output derived from the LVDT spool position, indicating the state of the main spool (neutral, A-port or B-port).

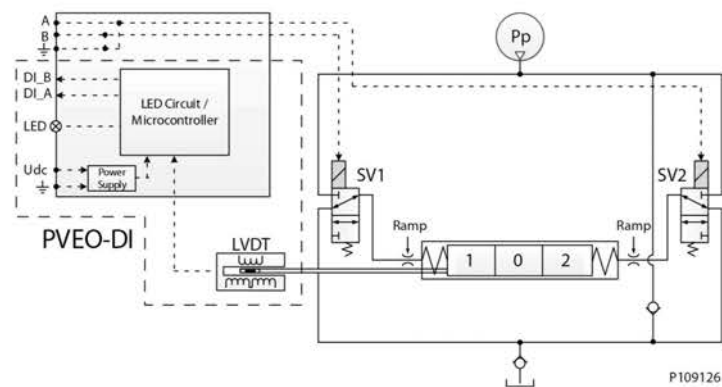
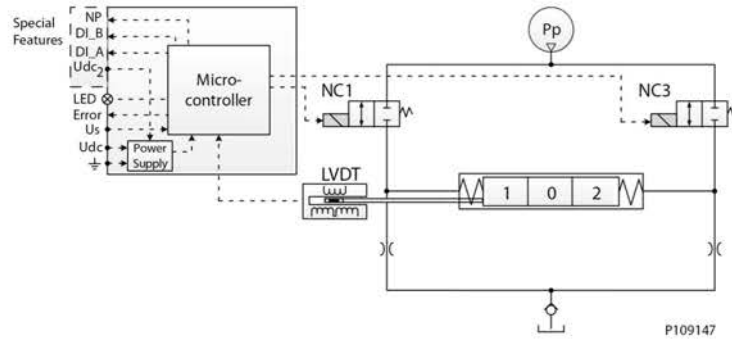
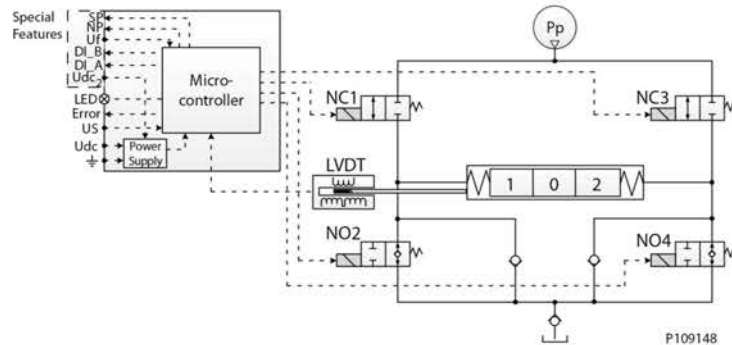
PVEO-DI functionality

PVEA-DI functionality

PVEH functionality

Special Features

The Direction Indication feature uses a dual power supply with the 2x4 pin AMP and DEUTSCH connectors as shown in the chapter [Connector Overview](#) on page 186.

When both DI_A and DI_B signals are High the main spool is in its neutral position.

When the DI_A signal goes Low and the DI_B signal stays High, the main spool is moving in the A-port direction, and vice versa. The relation between the direction indication feedback and the output signal is shown below.

Direction indication feedback

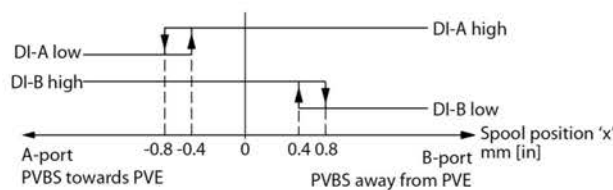

157-435.10

	A-Port	B-Port
DI signals a1, a2	-0.8 mm ± 0.4 mm	0.8 mm ± 0.4 mm
Max. DI load	200 mA	
DI High @ 20 mA	$> U_{DC} - 1.5 V_{DC}$	
DI High @ 100 mA	$> U_{DC} - 2.0 V_{DC}$	
DI Low	$< 0.2 V_{DC}$	

Dedicated Float Pin (UF)

The Dedicated Float Pin (UF) feature is related to the PVEH-FLA actuator variant enabling the user to move the main spool into its float position by power. The PVEH-FLA uses 1x6 pin AMP or DEUTSCH connectors.

- Normal operation: Low or not connected
- High Float
- Input range: U_{DC}
- Max. voltage: $32 V_{DC}$

PVEH-FLA functionality diagram

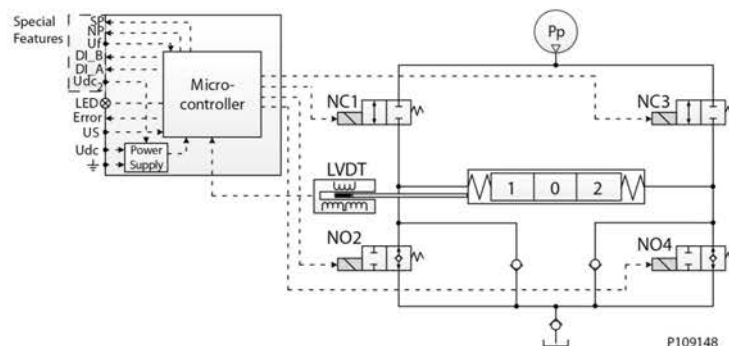

Special Features
Spool Position (SP)

The Spool Position (SP) feature available in the PVEH-SP/PVES-SP actuator variants enables the user to derive from the LVDT spool position of the main spool by means of an analog voltage signal on the dedicated spool position (SP) output pin.

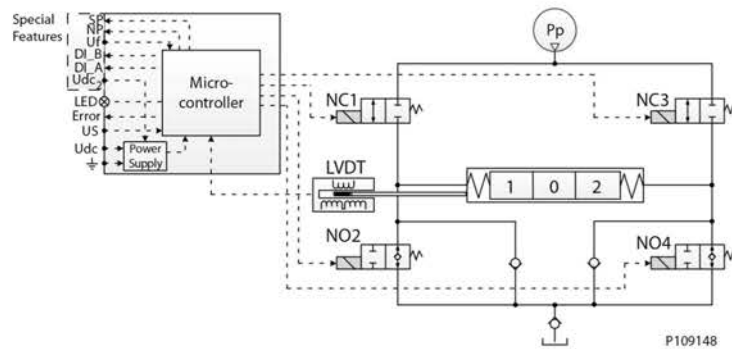
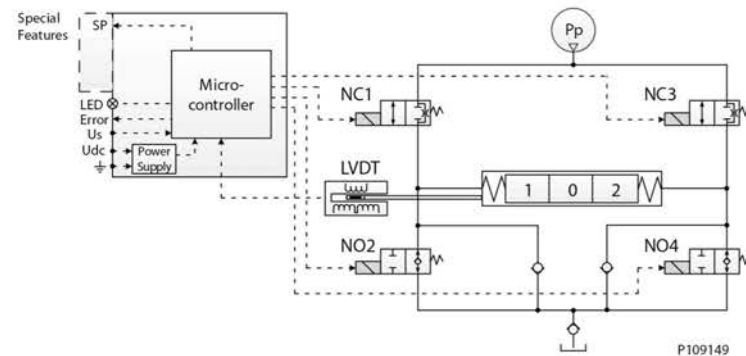
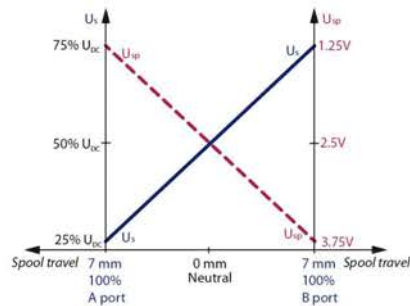
PVEH-SP functionality diagram

PVES-SP functionality diagram

Spool Position feedback

SP feedback signal from 0.5 to 4.0 V_{DC} inverted in direction relative to U_s 2.5 V_{DC} as the neutral value
 SP from neutral to maximum stroke (mm)
 SP maximum load is 0.5 mA
 Output range for A-port: 2.5 – 1.25 V_{DC} and for B-port: 2.5 – 3.75 V_{DC}

The PVEH-SP/PVES-SP uses a 1x6 DEUTSCH connector. For more information, please see [Connector Overview](#) on page 186.

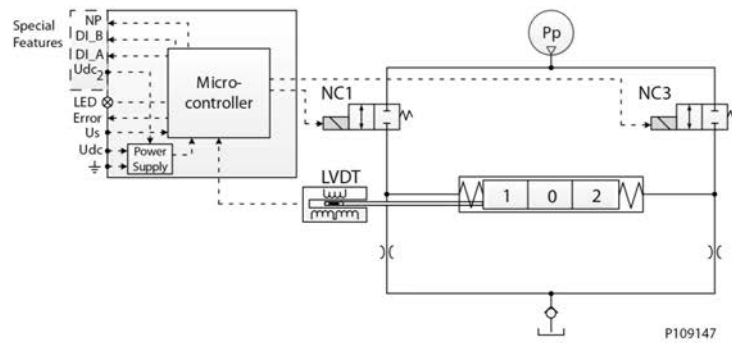
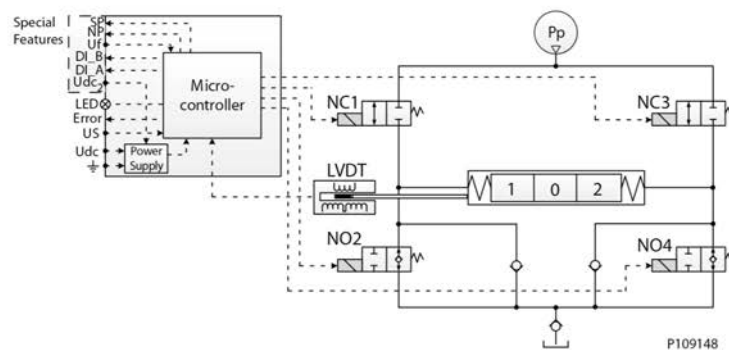
Technical Information
PVG 32 Proportional Valve Group
Special Features
Neutral Power-OFF (NP)

The Neutral Power-OFF (NP) feature available in the PVEA-NP and PVEH-NP actuator variants enables the user to identify whether the solenoid valves in the actuator are energized or de-energized via a dedicated neutral power-OFF (NP) output pin.

PVEA-NP functionality diagram

PVEH-NP functionality diagram

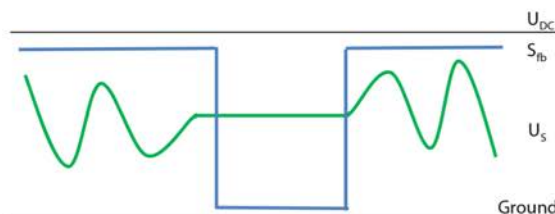
The Neutral Power-OFF (NP) signal is defined as shown below:

Solenoid disabling function (-NP) curves

- Normal operation from $> U_{DC}$ to $2 V_{DC}$
- Power Save $< 1 V_{DC}$ (solenoid valves de-energized)
- NP maximum load is 50 mA

The PVEA-NP/PVEH-NP uses a 1x6 DEUTSCH connector. For more information, please see [Connector Overview](#) on page 186.

Special Features

Disable Mode

The PVEH-U and PVES-U actuator variants controlled by a fixed 0-10 V_{DC} signal voltage (U_s), feature the ability to enter a disable mode. This causes the counteracting force on the main spool created by the solenoid valve bridge to deactivate, when using Manual OverRide (MOR).

The disable mode is entered by sending a signal voltage (U_s) of 15% or lower of 10 V_{DC} when in Power Save.

PVS End Plates

The PVG 32 PVS end plates close off the valve stack section placed between them by placing them at the end. Furthermore, the end plate is ensuring Load Sense (LS) is relieved to tank pressure when the valve is not operated.

The PVS end plate variants are based on a generic platform with a wide selection of additional features, enabling you to tailor the PVS to suit the demands of any hydraulic system.

The generic PVS end plates platform includes the following main variants:

- **PVS/PVSI** – Either aluminum or cast iron
- **PVS/PVSI with LX-connection** – Either aluminum or cast iron
- **PVSI with P-, T-, LX- and M-connection** – Cast iron
- **PVSI start plate** – Cast iron
- **PVSD** – Cast iron
- **PVSI with PVE PPRV** – Cast iron
- **PVST with T-connection** – Steel
- **PVST with PVE PPRV and PP dump** – Steel

PVS/PVSI

PVS/PVSI with LX-connection

PVSI with P-, T-, LX- and M-connection

PVST with T-connection

PVS End Plates
PVSI start plate

PVSI with PVE PPRV

PVSD end plate

PVST with PVE PPRV and PP dump

Technical specification

Parameter	Minimum	Recommended range	Maximum
Fluid temperature	-30°C [-22°F]	30 to 60°C [86 to 140°F]	90° [194°F]
Fluid viscosity	4 mm ² /s [39 SUS]	12 to 75 mm ² /s [65 to 347 SUS]	460 mm ² /s [2128 SUS]
Fluid cleanliness (mechanical activation)	23/19/16 (according to ISO 4406)		
Fluid cleanliness (PVE activation)	18/16/13 (according to ISO 4406)		
Operating temperature	Ambient: -30 to 60°C [-22 to 140°F]		

For more information about PVS End Plates, see:

- [PVS/PVSI on page 202](#)
- [PVS/PVSI with LX-connection on page 204](#)
- [PVSI with P-, T-, LX- and M-connection on page 206](#)
- [PVST with T-connection on page 207](#)
- [PVSI Start Plate on page 208](#)
- [PVSD End Plate on page 210](#)
- [PVSI with PVE PPRV on page 212](#)

PVS End Plates

PVST with PVE PPRV and PP dump on page 214

Technical Information
PVG 32 Proportional Valve Group
PVS End Plates
PVS/PVSI

The PVS/PVSI are made of either aluminum or cast iron material and works as an end plate.

The PVSI End Plates features:

- Integrated LS pressure relief to tank
- Optional integrated thermal orifice
- Optional version without seals

PVS/PVSI



PVS/PVSI dimensions

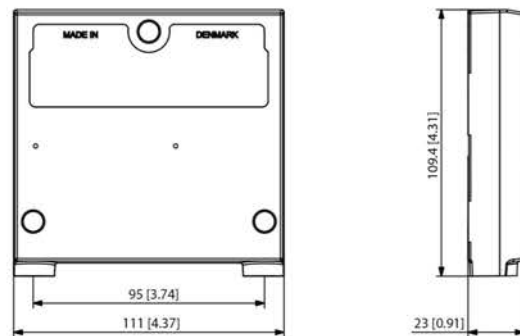

Weight: 0.47 kg [1.05 lb]

PVS/PVSI schematic



Maximum pressure for P- and T-port

Max. P-port continuous	Max. P-port intermittent	Max. T-port static/dynamic
350 bar [5076 psi]	400 bar [5800 psi]	25/40 bar [365/580 psi]

See part number table for details on maximum pressure capacity

Technical specification

Parameter	Minimum	Recommended range	Maximum
Fluid temperature	-30°C [-22°F]	30 to 60°C [86 to 140°F]	90° [194°F]
Fluid viscosity	4 mm ² /s [39 SUS]	12 to 75 mm ² /s [65 to 347 SUS]	460 mm ² /s [2128 SUS]
Fluid cleanliness (mechanical activation)	23/19/16 (according to ISO 4406)		
Fluid cleanliness (PVE activation)	18/16/13 (according to ISO 4406)		
Operating temperature	Ambient: -30 to 60°C [-22 to 140°F]		

Part numbers for PVS end plates

Part number	Maximum pressure	Material	Weight kg [lb]	Seals	Mounting
157B2000	300 bar [4351 psi]	Aluminum	0.475 [1.05]	Yes	M8
157B2020	300 bar [4351 psi]	Aluminum	0.475 [1.05]	Yes	5/16-18 UNC

Technical Information
PVG 32 Proportional Valve Group

PVS End Plates

Part numbers for PVS end plates (continued)

Part number	Maximum pressure	Material	Weight kg [lb]	Seals	Mounting
157B2004	350 bar [5076 psi]	Cast iron	1.745 [3.85]	Yes	5/16-18 UNC
157B2014	350 bar [5076 psi]	Cast iron	1.745 [3.85]	Yes	M8
157B2017	350 bar [5076 psi]	Cast iron	1.745 [3.85]	Yes	M10
157B2018	350 bar [5076 psi]	Cast iron	1.745 [3.85]	No ¹	M8
157B2902²	350 bar [5076 psi]	Cast iron	1.745 [3.85]	Yes	M8

¹ For use with priority modules.

² Thermal orifice 0.8 mm.

Technical Information
PVG 32 Proportional Valve Group
PVS End Plates
PVS/PVSI with LX-connection

The PVG 32 PVS end plates are placed at the end the valve stack section. Furthermore, the end plate is ensuring Load Sense (LS) is relieved to tank pressure when the valve is not operated. The LX port enables other remote valves to be connected onto the Load Sense shuttle network.

The PVS type end plates are made of aluminum while the PVSI types are made of cast iron thereby being able to withstand a higher pressure.

The PVS/PVSI with LX-port connection features:

- Threaded LX port for connecting another valve to LS network

PVS/PVSI with LX-connection

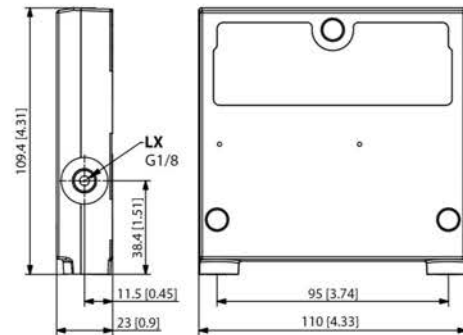
PVS/PVSI with LX-connection dimensions

PVS/PVSI with LX-connection schematic

Maximum pressure for P- and T-port

Max. P-port continuous	Max. P-port intermittent	Max. T-port static/dynamic
350 bar [5076 psi]	400 bar [5800 psi]	25/40 bar [365/580 psi]

[See part number table for details on maximum pressure capacity](#)

Technical specification

Parameter	Minimum	Recommended range	Maximum
Fluid temperature	-30°C [-22°F]	30 to 60°C [86 to 140°F]	90° [194°F]
Fluid viscosity	4 mm ² /s [39 SUS]	12 to 75 mm ² /s [65 to 347 SUS]	460 mm ² /s [2128 SUS]
Fluid cleanliness (mechanical activation)	23/19/16 (according to ISO 4406)		
Fluid cleanliness (PVE activation)	18/16/13 (according to ISO 4406)		
Operating temperature	Ambient: -30 to 60°C [-22 to 140°F]		

Technical Information
PVG 32 Proportional Valve Group

PVS End Plates
Part numbers for PVS/PVSI with LX-port connection

Part number	Max. pressure	Material	Weight kg [lb]	LX port	Mounting
157B2005	350 bar 5076 psi]	Cast iron	1.695 [3.74]	1/2-20 UNF	5/16-18 UNC
157B2015				G1/4"	M8
157B2910				M12x1.5 ISO 6149	
157B2011	300 bar [4351 psi]	Aluminum	0.495 [1.09]	G1/8"	M8
157B2021				3/8-24 UNF	5/16-18 UNC

Technical Information
PVG 32 Proportional Valve Group
PVS End Plates
PVSI with P-, T-, LX- and M-connection

PVSI is made of cast iron and works as an end plate. The PVSI with LX connection enables another valves LS pressure to be shuttled to the pump when needed. The additional P- and T-port connections enables an additional pump flow to a PVG 32 valve.

The PVSI with P-, T-, LX- and M-connection features:

- Threaded ports for P/T/LS/LX and M measuring gauge

PVSI with P-, T-, LX- and M-connection



PVSI with P-, T-, LX- and M-connection dimensions

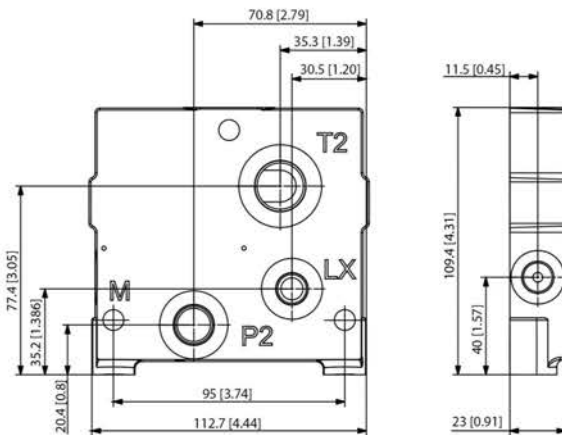

PVSI with P-, T-, LX- and M-connection schematic



Maximum pressure for P- and T-port

Max. P-port continuous	Max. P-port intermittent	Max. T-port static/dynamic
210 bar [3045 psi]	250 bar [3625 psi]	25/40 bar [365/580 psi]

Technical specification

Parameter	Minimum	Recommended range	Maximum
Fluid temperature	-30°C [-22°F]	30 to 60°C [86 to 140°F]	90° [194°F]
Fluid viscosity	4 mm ² /s [39 SUS]	12 to 75 mm ² /s [65 to 347 SUS]	460 mm ² /s [2128 SUS]
Fluid cleanliness (mechanical activation)	23/19/16 (according to ISO 4406)		
Fluid cleanliness (PVE activation)	18/16/13 (according to ISO 4406)		
Operating temperature	Ambient: -30 to 60°C [-22 to 140°F]		

Part number for PVSI with P-, T-, LX-, M-ports

Part number	P-port	T-port	LX-port	M-port	Mounting feet	Weight
157B2920	G3/8	G1/2	G1/4	G1/4	M8	2.5 kg [5.51 lb]

Technical Information
PVG 32 Proportional Valve Group
PVS End Plates
PVST with T-connection

The PVST end plate closes off the valve stack section placed between them by placing it at the end. Furthermore, the end plate is ensuring Load Sense (LS) is relieved to tank pressure when the valve is not operated.

The PVST End Plates features:

- Integrated LS pressure relief to tank
- Threaded T port
- Optional integrated thermal orifice

PVST with T-connection

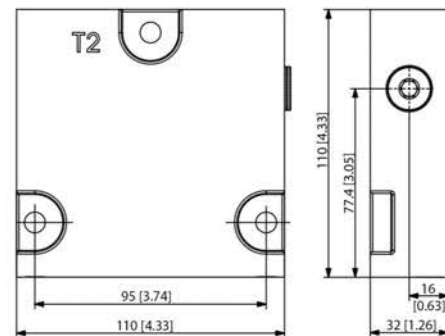
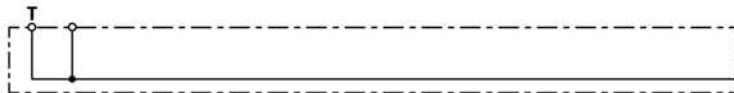
PVST with T-connection dimensions

PVST with T-connection schematic

Maximum pressure for P- and T-port

Max. P-port continuous	Max. P-port intermittent	Max. T-port static/dynamic
350 bar [5076 psi]	400 bar [5800 psi]	25/40 bar [365/580 psi]

Technical specification

Parameter	Minimum	Recommended range	Maximum
Fluid temperature	-30°C [-22°F]	30 to 60°C [86 to 140°F]	90° [194°F]
Fluid viscosity	4 mm ² /s [39 SUS]	12 to 75 mm ² /s [65 to 347 SUS]	460 mm ² /s [2128 SUS]
Fluid cleanliness (mechanical activation)	23/19/16 (according to ISO 4406)		
Fluid cleanliness (PVE activation)	18/16/13 (according to ISO 4406)		
Operating temperature	Ambient: -30 to 60°C [-22 to 140°F]		

When using a PVST with T-connection it is not possible to use the LS A/B fitting in the bottom of the PVG section next to the PVST.

Technical Information
PVG 32 Proportional Valve Group
PVS End Plates
Part numbers for PVST with T-connection

Part number	Material	T-port	Mounting feet	Weight
157B2500	Steel	G1/2	M8	0.47 kg [1.05 lb]
157B2520		7/8-14	5/16-18	
157B2912	Iron	M22x1.5 DIN 3852-1	M8	0.6 kg [1.32 lb]
11004462		M22x1.5 ISO 6149		

PVSI Start Plate

The PVG 32 PVSI iron start plates is for use with PVPM in a closed center configuration for use with variable displacement pumps.

The PVSI Start Plates features:

- Integrated pilot pressure reducing valve (PPRV) for PVE or PVH/PVHC
- Integrated sealing for groups with/without T0 port
- Threaded ports for LS and T0 port

PVSI start plate

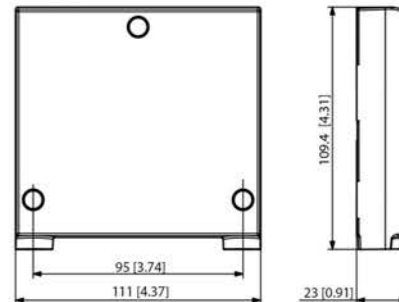
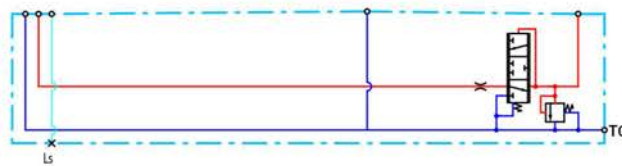
Dimensions

Schematic

Maximum pressure for P- and T-port

Max. P-port continuous	Max. P-port intermittent	Max. T-port static/dynamic
350 bar [5076 psi]	400 bar [5800 psi]	25/40 bar [365/580 psi]

Technical Information
PVG 32 Proportional Valve Group

PVS End Plates
Part numbers for PVS1 start plates

Part number	Actuation	LS-, T0-port	Mounting	Weight
11091772	PVE	9/16-18-UNF	5/16-18 UNC	1.6 kg [3.53 lb]
11091773	PVE	G1/4"	M8	
11322913	PVH/PVHC	G1/4"	M8	
11322914	PVH/PVHC	9/16-18-UNF	5/16-18 UNC	

Technical Information
PVG 32 Proportional Valve Group
PVS End Plates
PVSD End Plate

The PVSD cast iron end plates are used for preventing T-line peaks and spillage and closing off the valve stack section at the end.

Furthermore, the end plate is ensuring Load Sense (LS) is relieved to tank pressure while the valve is not operated and features threaded P and V (spillage) ports.

Vented port (V-port) should be connected to a spillage tank.

PVSD end plate



Schematic

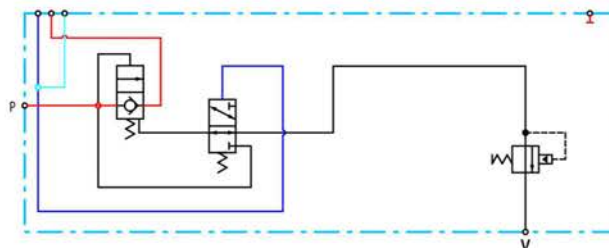

Dimensions

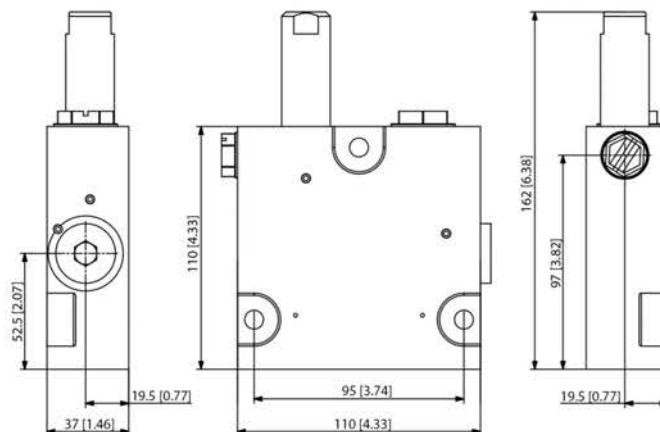

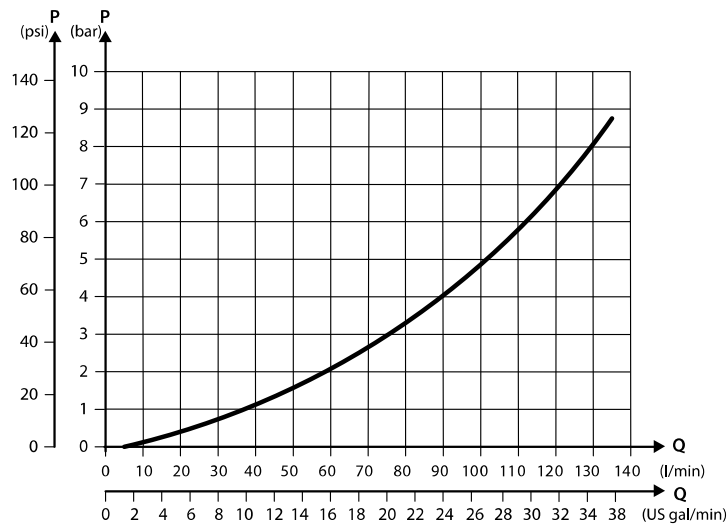
Technical Information
PVG 32 Proportional Valve Group
PVS End Plates
Pressure drop P to P characteristic

Maximum pressure, flow and leakage

Max. P-port continuous	Max. T-port static/ dynamic	Max. rated pump flow	V- port leakage
210 bar [3046 psi]	50 bar [725 psi]	120 l/min [31.7 US gal/min]	1 cm ³ [0.06 in ³] / hour

Part number for PVSD end plate

Part number	P-port	V-port	Weight	Mounting
157B2904	G1/2"	G1/4"	3.01 kg [6.64 lb]	M8

Technical Information
PVG 32 Proportional Valve Group
PVS End Plates
PVSI with PVE PPRV

The PVG 32 PVS end plates close off the valve stack section placed between them by placing them at the end. Furthermore, the end plate is ensuring Load Sense (LS) is relieved to tank pressure when the valve is not operated.

The integrated pilot pressure reduction valve (PPRV) is intended a valve group with electro-hydraulic controlled work sections.

The PVSI with PVE PPRV features:

- Integrated pilot pressure reducing valve (PPRV) for PVE
- Threaded T0 port

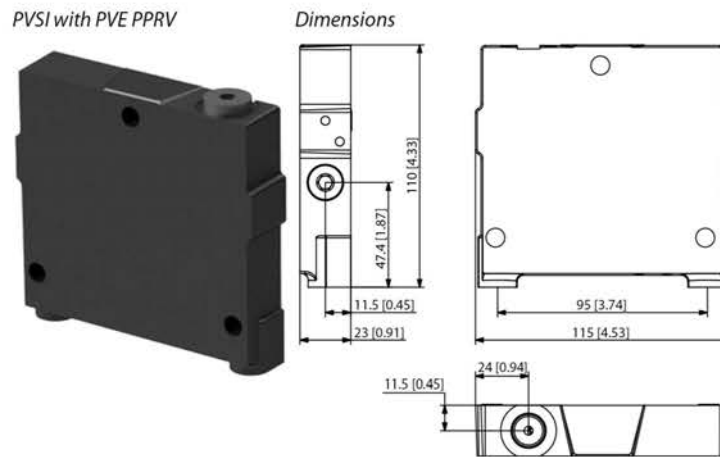
Schematic

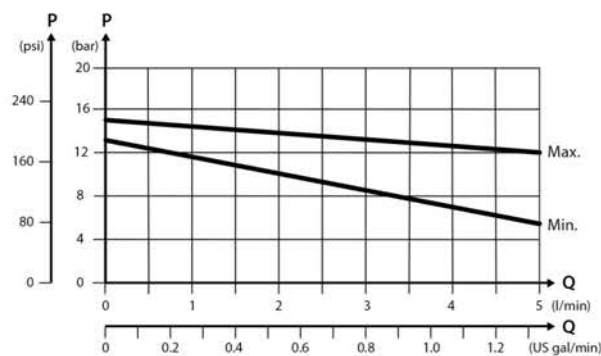
Pilot pressure reduction valve characteristics

Maximum pressure for P- and T-port

Max. P-port continuous	Max. P-port intermittent	Max. T-port static/dynamic
350 bar [5076 psi]	400 bar [5800 psi]	25/40 bar [365/580 psi]

Technical Information
PVG 32 Proportional Valve Group

PVS End Plates

Part number for PVS1 with PVE PPRV plate

Part number	T0-port	Weight	Mounting
157B2917	M14x1.5	0.48 kg [1.05 lb]	M8

Technical Information
PVG 32 Proportional Valve Group
PVS End Plates
PVST with PVE PPRV and PP dump

The PVG 32 PVS end plates close off the valve stack section placed between them by placing them at the end. Furthermore, the end plate is ensuring Load Sense (LS) is relieved to tank pressure when the valve is not operated.

The integrated pilot pressure reduction valve (PPRV) is intended a valve group with electro-hydraulic controlled work sections. The pilot pressure can be dumped to tank thereby preventing any electrical activation of the work sections.

The selectable LX port enables other remote valves to be connected onto the Load Sense shuttle network.

The PVST with PVE PPRV and PP dump features:

- Integrated pilot pressure reducing valve (PPRV) for PVE
- Integrated pilot oil dump valve
- Threaded T and LX port
- Selector for LX or not LX modes

PVST with PVE PPRV and PP dump



Schematic

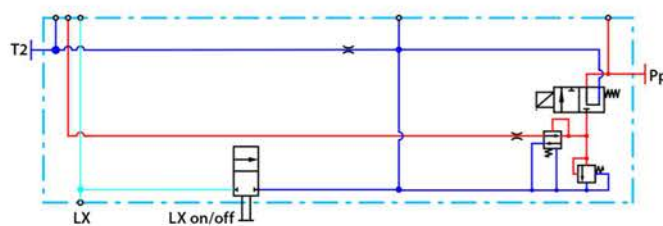

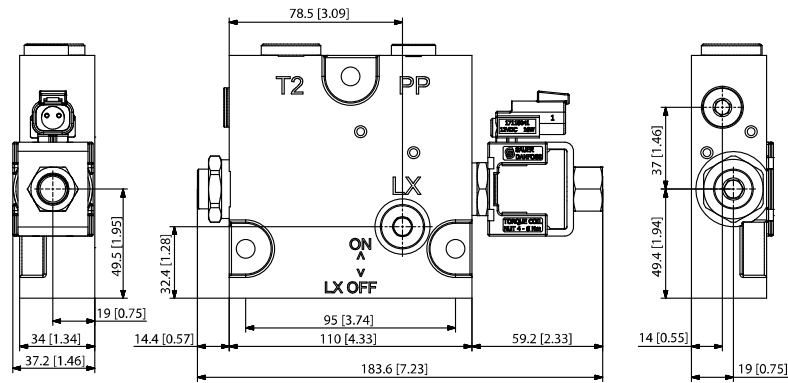
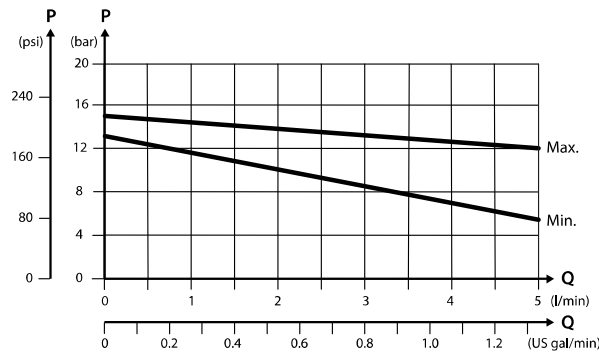
Technical Information
PVG 32 Proportional Valve Group
PVS End Plates
Dimensions

Pilot pressure reduction valve characteristics

Maximum pressure for P- and T-port

Max. P-port continuous	Max. P-port intermittent	Max. T-port static/dynamic
210 bar [3045 psi]	280 bar [4061 psi]	25/40 bar [365/580 psi]

Part number for PVST with PPRV/PP dump

Part number	T0, LX-port	T- port	PP dump	Weight	Mounting
11050065	M14x1.5	M22x1.5	12 V _{DC}	3.2 kg [7.05 lb]	M8
11067069	M14x1.5	M22x1.5	24 V _{DC}	3.2 kg [7.05 lb]	M8

Technical Information
PVG 32 Proportional Valve Group
PVSKM Full Flow Cut Off Modules

The PVSKM full flow cut-off valve is developed to comply with the new functional safety standards. PVSKM is a cost-efficient way to implement a redundant hydraulic architecture for category 2 or 3 safety functions. Applying PVSKM in a PVG valve will offer two independent hydraulic cut-off possibilities for flow to work functions. PVSKM can be placed anywhere in the PVG valve stack to close the entire valve group or just a part of it, depending on the position. One or more PVSKM valves can be placed in the PVG 32 valve to make the system redundant.

PVSKM module can be used in all combination: closed and open center both at satellite PVG stack and Build in PVG stack. Spools are divided in two main categories, one that support open center system out of HPCO connection and another that support closed center system out of HPCO connection. Both categories of spools supporting closed and open center systems in build in PVG.

PVSKM module can send flow up to 125 L/min trough the build in PVG and up to 200 L/min out of HPCO port. HPCO port flow can variate due to the spool properties of the chosen spool.

PVSKM modules will be available with different port connection size: 3/4 BSP, 3/4 BSP with T0, 1-1/6 UNF with T0 and 1" BSP. Remember if PVSKM chosen with 1" port and PVP have 1" port, a spacer in between is needed.

PVSKM slice

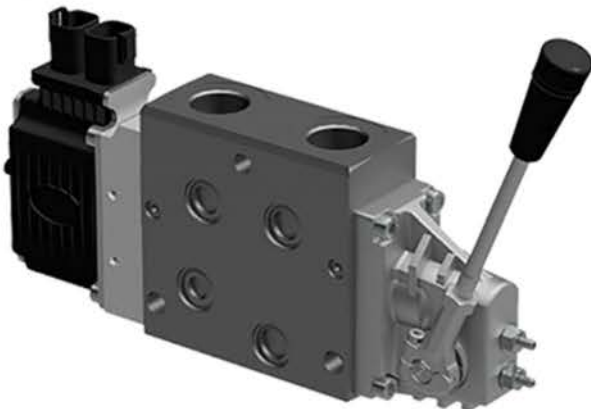

PVSKM module dimensions

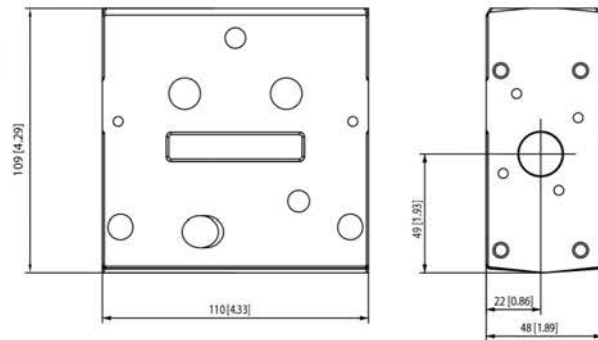

Available modules

Description	Part number according to port type	
	3/4" BSP	1-1/16 UNF
Module without T0	11133574	-
Module with T0	11150521	11133580

Schematic with T0

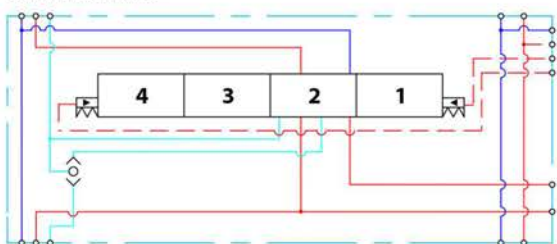

Schematic without T0

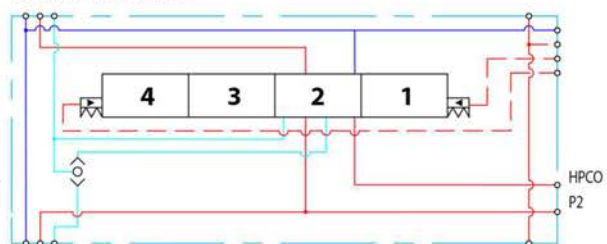

Technical Information
PVG 32 Proportional Valve Group
PVSKM Full Flow Cut Off Modules

All spools are suited for CC and OC system in build in PVG stack. Spools should be chosen according to the satellite PVG system that is connected to HPCO port.

Standard mount Spools with electrical actuation

Description	Part number according to HPCO flow			
	25 [6.6]	50 [13.2]	100 [26.4]	Max
OC system connection to HPCO	11149045	11149047	11149049	11149053
CC system connection to HPCO	11149046	11149048	11149050	11149054

Optional mount Spools with electrical actuation

Description	Part number according to HPCO flow			
	25 [6.6]	50 [13.2]	100 [26.4]	Max
OC system connection to HPCO	11175360	-	-	11175362
CC system connection to HPCO	11175361	-	-	11175363

Standard mount Spools with hydraulic actuation

Description	Part number according to HPCO flow			
	25 [6.6]	50 [13.2]	100 [26.4]	Max
OC system connection to HPCO	-	-	-	11175365
CC system connection to HPCO	-	-	-	11175368

Technical data

Max. Pressure	Port P continuous	350 bar [5075 psi]	
	Port HPCO continuous		
Oil rated flow	P-PVG	OC system	85 l/min [22.5 US gal/min]
		CC system	125 l/min [33 US gal/min]
Oil rated flow	P- HPCO	OC system	210 l/min [55.48 US gal/min]
		CC system	210 l/min [55.48 US gal/min]
Oil rated flow	P- P2	OC system	85 l/min [22.5 US gal/min]
		CC system	125 l/min [33 US gal/min]
Oil temperature (inlet temperature)	Recommended temperature	30 to 60 °C [86 to 140 °F]	
	min. Temperature	-30 °C [-22 °F]	
	max. Temperature	90 °C [194 °F]	
Ambient Temperature	Recommended	-30 to 70 °C [-22 to 158 °F]	
Oil Viscosity	Operating range	12 - 75 mm/s [65-347 SUS]	
	Min. Viscosity	4 mm/s [39 SUS]	
	Max. Viscosity	460 mm/s [2128 SUS]	
Filtration	Max. Contamination (ISO 4406)	23/19/16	

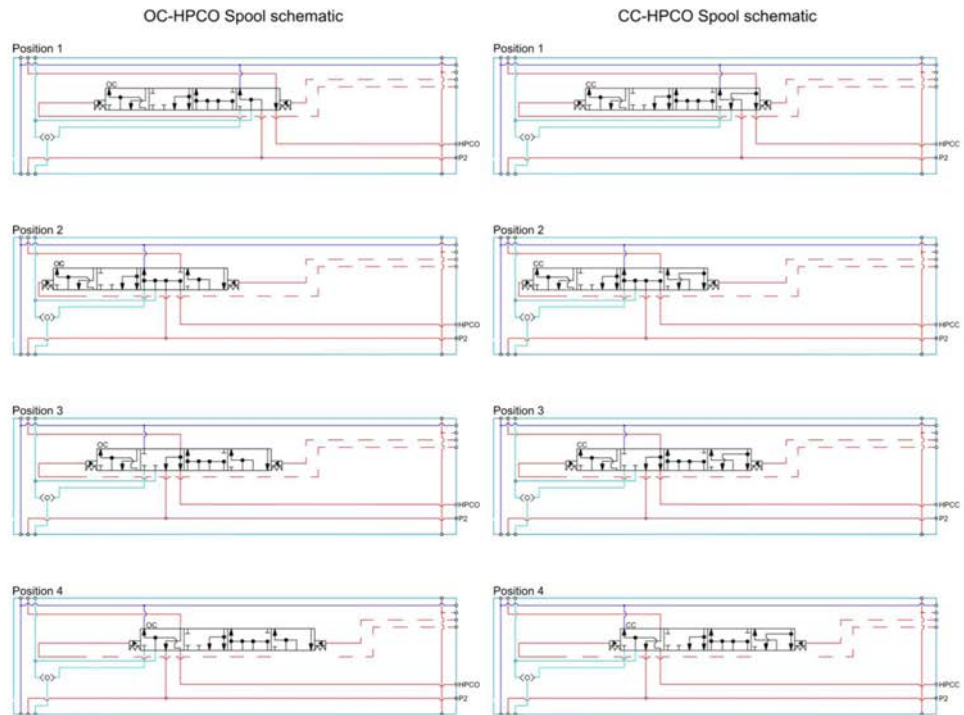
PVSKM Full Flow Cut Off Modules

PVSKM spools have four positions (See picture above)

Position	Description	Spool position	Characteristic control
1	HPCO PORT	From -1.8 mm to -7mm	Proportional
2	Neutral	From -1.8 mm to 2.3 mm	none
3	PVG/HPCO	From 2.3 mm to 4.5 mm	On/Off
4	PVG/P2	From 4.5mm to 7 mm	On/Off

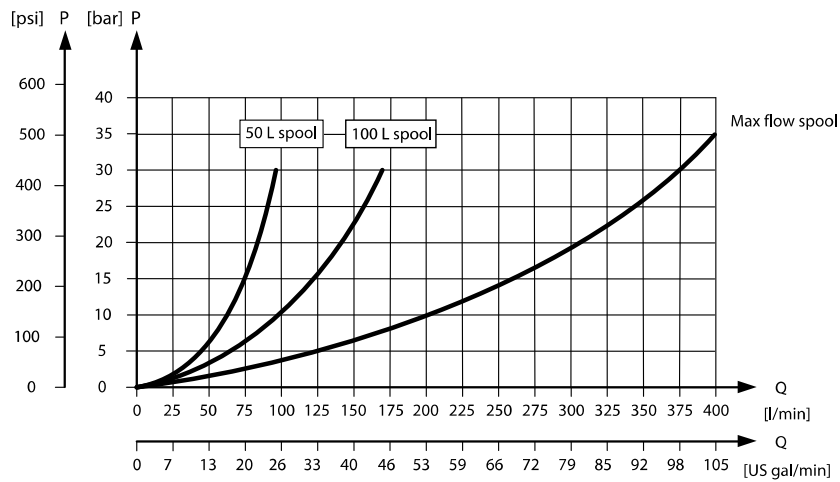
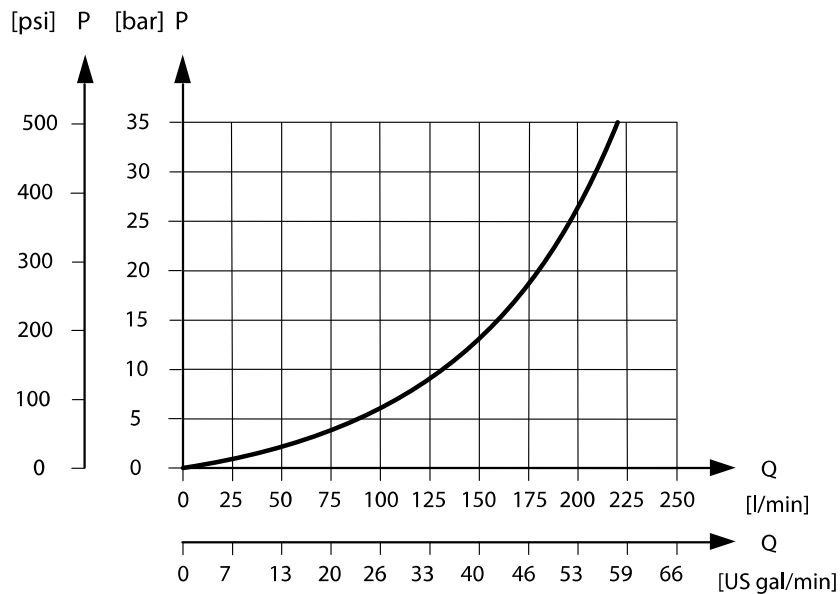
Technical Information
PVG 32 Proportional Valve Group
PVSKM Full Flow Cut Off Modules
Spool characteristics
Flow out of HPCO-port

P-PVG flow

Technical Information
PVG 32 Proportional Valve Group

PVSKM Full Flow Cut Off Modules

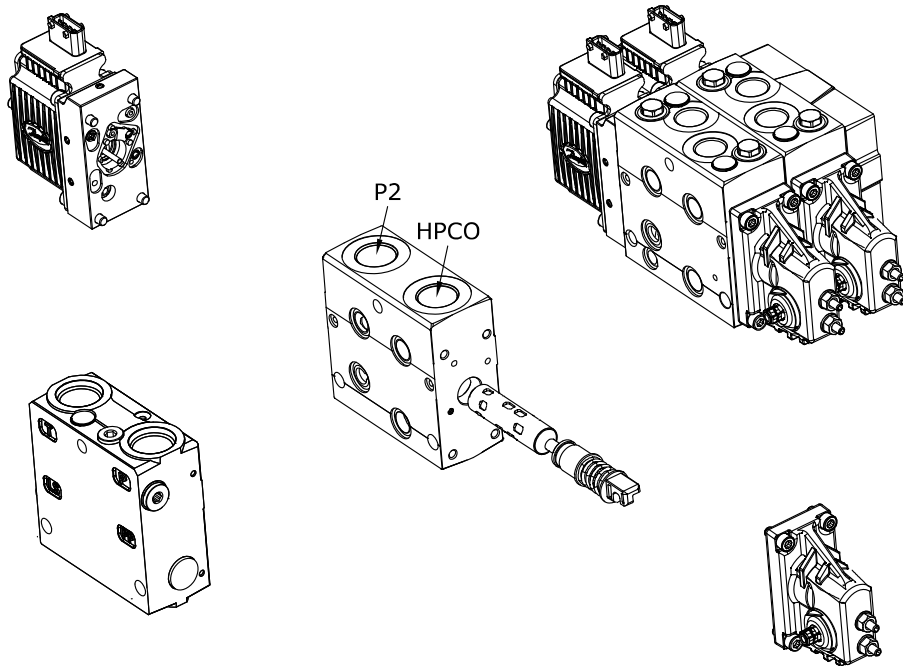
Standard mount of the PVSKM



Optional mount of the PVSKM

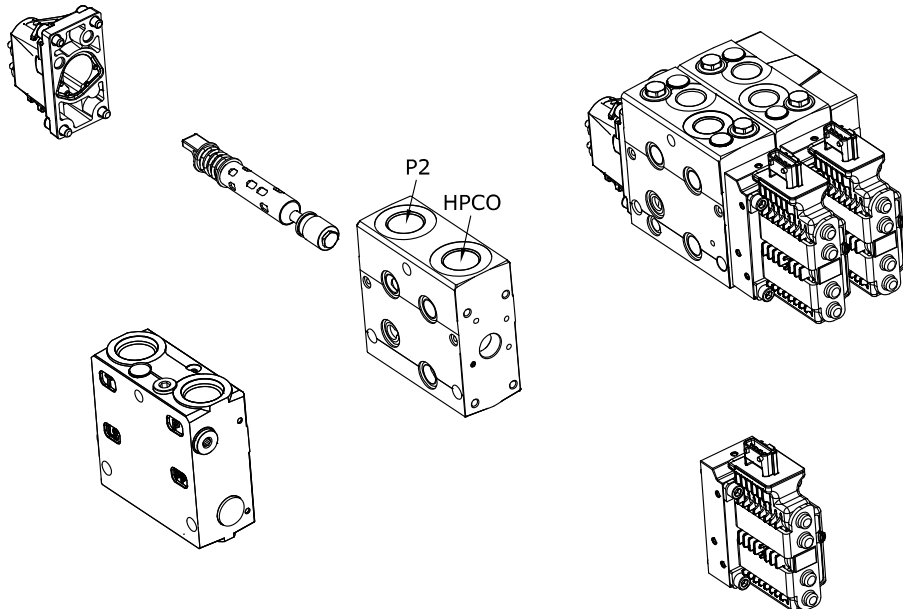

PVAS Stay Bolts

PVAS Stay Bolts kit for various PVG combinations consist of three tie rods, six washers, six nuts and O-ring. Use the guide and reference tables how to choose PVAS kit.

The tie rods are inserted through the entire length of the PVG valve stack. The nuts are tightened at the pump side and at the end plate.

To find the PVAS kit that fits your PVG 16 valve stack, you need to go to the table [PVG 32 modules total length](#) on page 222 and find the length. Then go to the table [PVAS Part Numbers](#) on page 221 and find the matching part number.

For stay bolts for a PVG 32/16 combination, see this [PVG 32/16 Combinations](#) on page 222.

Stay bolts for PVG 256/128/32/16 combinations consist of two different kits. See [PVG 256/128/32/16 Combinations](#) on page 223 to find the right kits for your combination.

Combinations with PVG 100 and PVG 120 requires special PVAS kits. These are not included in the PVAS table.

PVAS Part Numbers

PVAS part numbers according to accumulated length interval PVG 32.

PVAS part numbers

Length, mm [in]	Part number	Length, mm [in]	Part number
20 – 48 [0.79 – 1.89]	11188219	361 – 372 [14.21 – 14.65]	11188205
49 – 60 [1.93 – 2.36]	11188218	373 – 384 [14.69 – 15.12]	157B8026
61 – 72 [2.40 – 2.83]	157B8000	385 – 396 [15.16 – 15.59]	11188204
73 – 84 [2.87 – 3.31]	11188217	397 – 408 [15.63 – 16.06]	157B8007
85 – 96 [3.35 – 3.78]	157B8031	409 – 420 [16.10 – 16.54]	11188203
97 – 108 [3.82 – 4.25]	11188216	421 – 432 [16.58 – 17.01]	157B8027
109 – 120 [4.29 – 4.72]	157B8001	433 – 444 [17.05 – 17.48]	11188202
121 – 132 [4.76 – 5.20]	11188215	445 – 456 [17.52 – 17.95]	157B8008
133 – 144 [5.24 – 5.67]	157B8021	457 – 468 [17.99 – 18.43]	11188201
145 – 156 [5.71 – 6.14]	11188214	469 – 480 [18.47 – 18.90]	157B8028
157 – 168 [6.18 – 6.61]	157B8002	481 – 492 [18.94 – 19.37]	11188200
169 – 180 [6.65 – 7.09]	11188213	493 – 504 [19.41 – 19.84]	157B8009
181 – 192 [7.13 – 7.56]	157B8022	505 – 516 [19.88 – 20.31]	11188199
193 – 204 [7.60 – 8.03]	11188212	517 – 528 [20.35 – 20.79]	157B8029
205 – 216 [8.07 – 8.50]	157B8003	529 – 540 [20.83 – 21.26]	11188198
217 – 228 [8.54 – 8.98]	11188211	541 – 552 [21.30 – 21.73]	157B8010
229 – 240 [9.02 – 9.45]	157B8023	553 – 564 [21.77 – 22.20]	11188197
241 – 252 [9.49 – 9.92]	11188210	565 – 576 [22.24 – 22.68]	157B8030
253 – 264 [9.96 – 10.39]	157B8004	577 – 588 [22.72 – 23.15]	11188196
265 – 276 [10.43 – 10.87]	11188209	589 – 600 [23.19 – 23.62]	157B8061
277 – 288 [10.91 – 11.34]	157B8024	601 – 612 [23.66 – 24.09]	11188195
289 – 300 [11.38 – 11.81]	11188208	613 – 624 [24.13 – 24.57]	157B8081
301 – 312 [11.85 – 12.28]	157B8005	625 – 636 [24.61 – 25.04]	11188194
313 – 324 [12.32 – 12.76]	11188207	637 – 648 [25.08 – 25.51]	157B8062
325 – 336 [12.80 – 13.23]	157B8025	649 – 660 [25.55 – 25.98]	11188189
337 – 348 [13.27 – 13.70]	11188206	661 – 672 [26.02 – 26.46]	157B8082
349 – 360 [13.74 – 14.17]	157B8006		

Technical Information

PVG 32 Proportional Valve Group
PVAS Stay Bolts
PVG 32 modules total length

Table with total length of the PVG 32 depending on the number of PVB modules.

No. of PVB 32	1	2	3	4	5	6	7	8	9	10	11	12
Length mm [in]	119 [4.69]	167 [6.57]	215 [8.46]	263 [10.35]	311 [12.24]	359 [14.13]	407 [16.02]	455 [17.91]	503 [19.80]	551 [21.69]	599 [23.58]	647 [25.47]

PVG 32/16 Combinations

The table of PVB 32 and PVB 16 modules combination, the total length depending on the amount of valve groups.

		PVB 16										
Modules in mm [in]		1	2	3	4	5	6	7	8	9	10	11
PVB 32	1	159 [6.26]	199 [7.83]	239 [9.41]	279 [10.98]	319 [12.56]	359 [14.13]	399 [15.71]	439 [17.28]	479 [18.86]	519 [20.43]	559 [22.01]
	2	207 [8.15]	247 [9.72]	287 [11.30]	327 [12.87]	367 [14.45]	407 [16.02]	447 [17.60]	487 [19.17]	527 [20.74]	567 [22.32]	607 [23.90]
	3	255 [10.04]	295 [11.61]	335 [13.19]	375 [14.76]	415 [16.34]	455 [17.91]	495 [19.49]	535 [21.06]	575 [22.64]	615 [24.21]	655 [25.79]
	4	303 [11.93]	343 [13.50]	383 [15.08]	423 [16.65]	463 [18.23]	503 [19.80]	543 [21.38]	583 [22.95]	623 [24.53]	663 [26.10]	-
	5	351 [13.82]	391 [15.39]	431 [16.97]	471 [18.54]	511 [20.12]	551 [21.69]	591 [23.27]	631 [24.84]	671 [26.42]	-	-
	6	399 [15.71]	439 [17.28]	479 [18.86]	519 [20.43]	559 [22.01]	599 [23.58]	639 [25.16]	-	-	-	-
	7	447 [17.60]	487 [19.17]	527 [20.75]	567 [22.32]	607 [23.90]	647 [25.47]	-	-	-	-	-
	8	495 [19.49]	535 [21.06]	575 [22.64]	615 [24.21]	655 [25.79]	-	-	-	-	-	-
	9	543 [21.38]	583 [22.95]	623 [24.53]	663 [26.10]	-	-	-	-	-	-	-
	10	591 [23.27]	631 [24.84]	671 [26.42]	-	-	-	-	-	-	-	-
	11	639 [25.16]	-	-	-	-	-	-	-	-	-	-

Technical Information
PVG 32 Proportional Valve Group
PVAS Stay Bolts
PVG 256/128/32/16 Combinations

The tables of PVB 256/128, 32/16 modules, total length depending on the amount of valve groups.

Stay bolts for PVG 128/256/32/16 combinations consist of 2 different kits:

1. For PVAS containing 2 stay bolts – please look in the *Table 1* below and use the part number before the + symbol.
2. For PVAS containing 3 stay bolts – please look in *Table 1* below and write down the length in millimeters which is the number after the + symbol. Next you add the number from *Table 2* below. Now find the part number for the needed stay bolts in the table *PVAS Part Numbers* on page 221.

O-rings are a part of the PVAS kits – no additional part number needed.

 **Caution**

It is not possible to do combinations exceeding **672 mm**.

Example

For 2 PVB 256 and 1 PVB 128 and 1 PVB 32 and 2 PVB 16: PVAS 1 Part number = **11187681** from *Table 1*.

PVAS 2 = **278** mm from *Table 1* + **152** mm from *Table 2* = 278+152 =430 mm which equals **157B8027** in the PVAS table.

Table 2 – PVG 256/128 combinations

		PVB 256							
Modules (mm)		0	1	2	3	4	5	6	7
PVB 128	0	11187676+ 40	11187672+ 126	11187673+ 212	11187656+ 298	11187675+ 384	11187696+ 470	11187697+ 556	11187698+ 642
	1	11187320+ 106	11187677+ 192	11187681+ 278	11187658+ 364	11187685+ 450	11187687+ 536	11187690+ 622	
	2	11187617+ 172	11187678+ 258	11187682+ 344	11187686+ 430	11187691+ 516	11187704+ 602		
	3	11187655+ 238	11187679+ 324	11187683+ 410	11187705+ 496	11187694+ 582	11187695+ 668		
	4	11187684+ 304	11187680+ 390	11187696+ 476	11187697+ 562	11187689+ 648			
	5	11187658+ 370	11187699+ 456	11187688+ 542	11187710+ 628				
	6	11187693+ 436	11187703+ 522	11187704+ 608					
	7	11187705+ 502	11187694+ 588						
	8	11187692+ 568	11187709+ 654						
	9	11187710+ 634							

Technical Information
PVG 32 Proportional Valve Group

PVAS Stay Bolts

Table 2 – PVG 32/16 combinations

		PVB 16										
Modules (mm)	0	1	2	3	4	5	6	7	8	9	10	
PVB 32	0	-	64	104	144	184	224	264	304	344	384	424
	1	72	112	152	192	232	272	312	352	392	432	-
	2	120	160	200	240	280	320	360	400	440	-	-
	3	168	208	248	288	328	368	408	448	-	-	-
	4	216	256	296	236	276	416	456	-	-	-	-
	5	264	304	344	384	424	464	-	-	-	-	-
	6	312	352	392	432	472	-	-	-	-	-	-
	7	360	400	440	480	-	-	-	-	-	-	-
	8	408	448	488	-	-	-	-	-	-	-	-
	9	456	496	-	-	-	-	-	-	-	-	-
	10	504	-	-	-	-	-	-	-	-	-	-

Technical Information
PVG 32 Proportional Valve Group

PVG 32 Combinations Valve Stack Dimensions

PVG 32 Dimensions

PVG 32 with PVE actuator

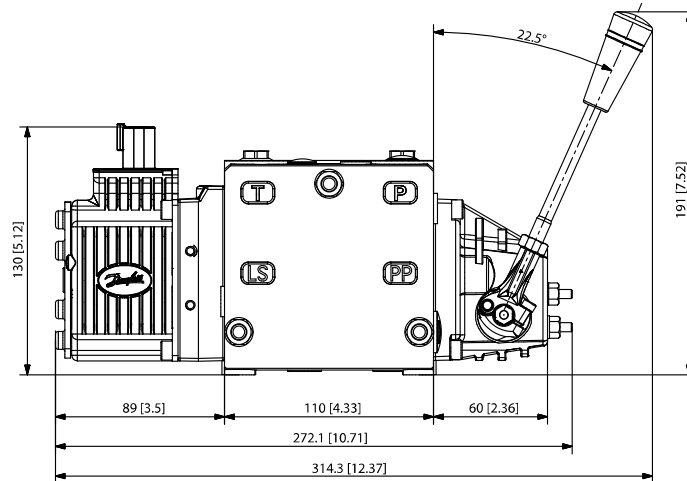

PVG 32 with PVHC

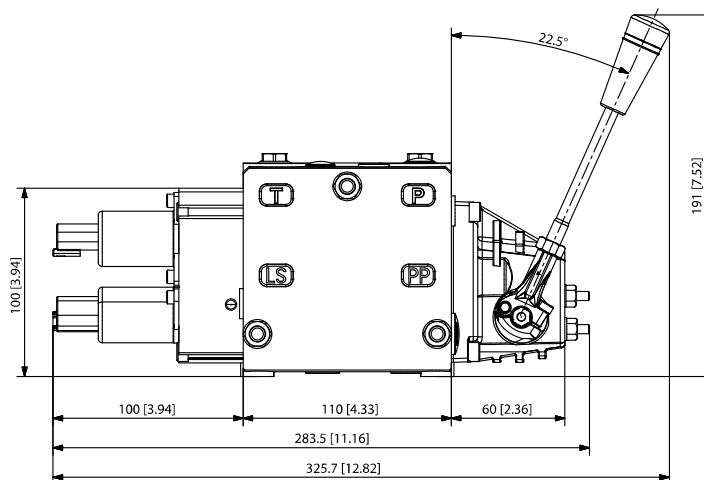

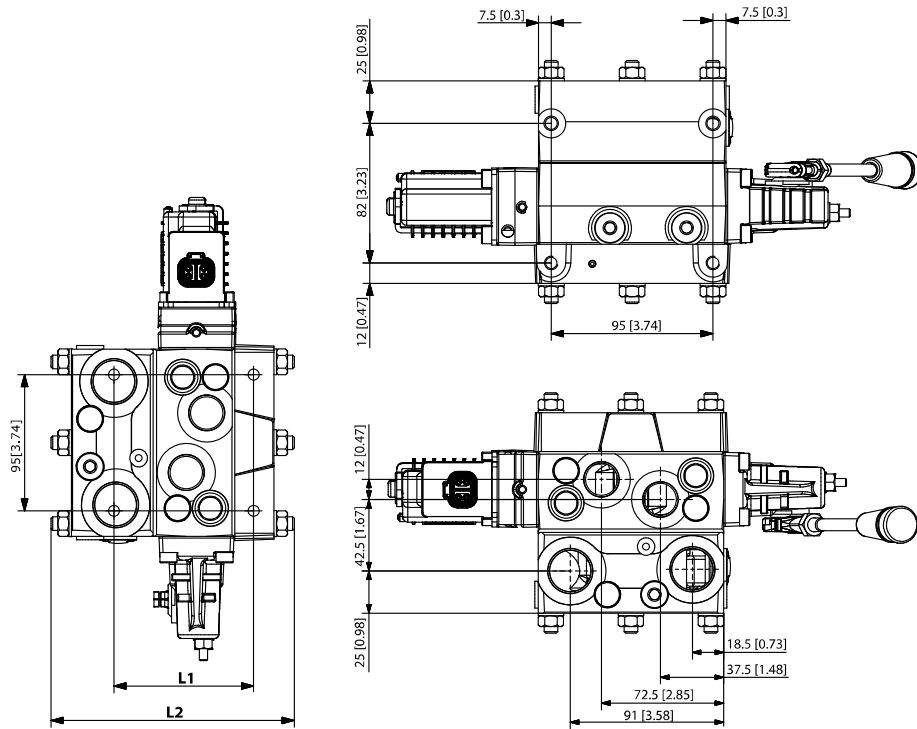
Technical Information
PVG 32 Proportional Valve Group
PVG 32 Combinations Valve Stack Dimensions

Number of PVB 32		1	2	3	4	5	6	7	8	9	10	11	12
L1	mm [in]	82 [3.23]		178 [7.01]130 [5.12]	226 [8.90]	274 [10.79]	322 [12.68]	370 [14.57]	418 [16.46]	466 [18.35]	514 [20.24]	562 [22.13]	610 [24.02]
L2	130 [5.12mm [in]	141 [5.55]	190 [7.48]	238 [9.37]	287 [11.30]	335 [13.19]	384 [15.12]	432 [17.01]	481 [18.94]	529 [20.83]	578 [22.76]	626 [24.65]	675 [26.57]
Weight	kg [lb]	8,33 [18.36]	11,46 [25.26]	14,53 [32.03]	17,66 [38.93]	20,74 [45.72]	23,81 [52.49]	26,94 [59.39]	30,01 [66.16]	33,09 [72.95]	36,21 [79.83]	39,29 [86.62]	42,26 [93.17]

Weight is for a PVG 32 with PVEO series 7 on each working section and is only approximate.

Technical Information
PVG 32 Proportional Valve Group
PVG 32 Combinations Valve Stack Dimensions
PVG 32/16 Dimensions

The table of PVB 32 and PVB 16 combination valve stack dimensions overview table with accompanying drawing.

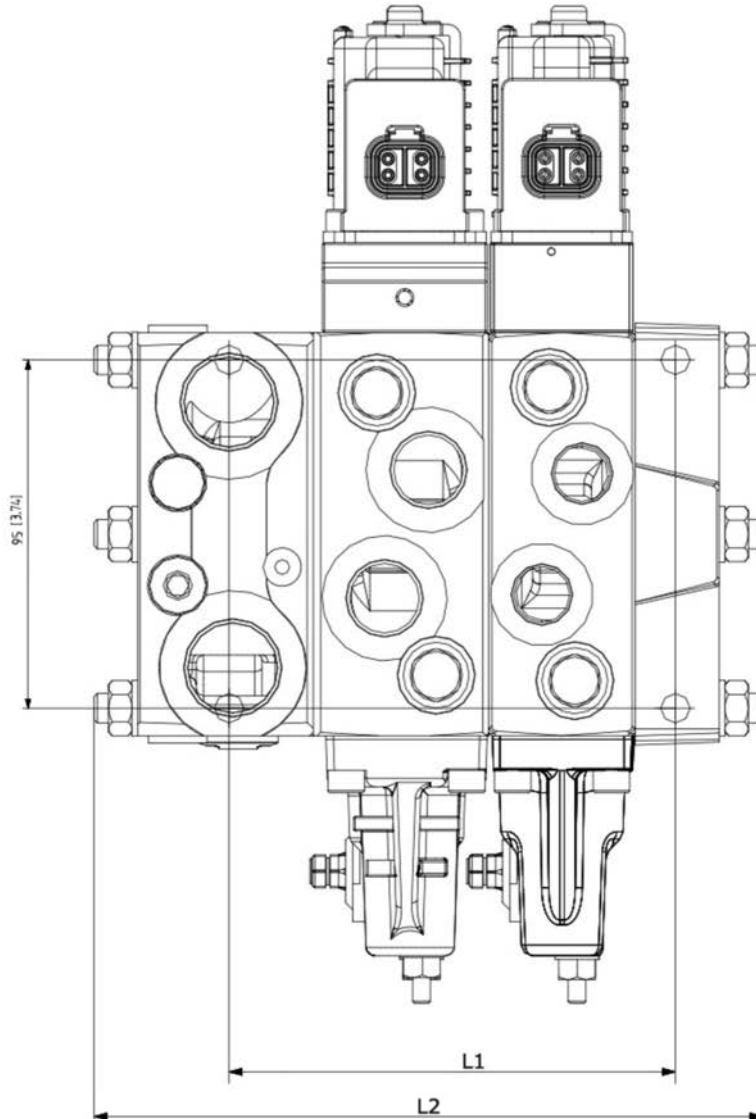

PVB 32/16 combination valve stack dimensions, mm [in]

Number of PVB 32 (down)		Number of PVB 16 modules										
		1	2	3	4	5	6	7	8	9	10	11
1	L1	122 [4.80]	162 [6.38]	202 [7.95]	242 [9.53]	282 [11.10]	322 [12.68]	362 [14.25]	402 [15.83]	442 [17.40]	482 [18.98]	522 [20.55]
	L2	189 [7.44]	238 [9.37]	262 [10.31]	311 [12.24]	360 [14.17]	385 [15.16]	434 [17.09]	483 [19.02]	507 [19.96]	551 [21.69]	600 [23.62]

PVG 32 Combinations Valve Stack Dimensions
PVB 32/16 combination valve stack dimensions, mm [in] (continued)

Number of PVB 32 (down)		Number of PVB 16 modules										
		1	2	3	4	5	6	7	8	9	10	11
2	L1	170 [6.69]	210 [8.27]	250 [9.84]	290 [11.42]	330 [12.99]	370 [14.57]	410 [16.14]	450 [17.72]	490 [19.29]	530 [20.87]	570 [22.44]
	L2	238 [9.37]	287 [11.30]	311 [12.24]	360 [14.17]	409 [16.10]	434 [17.09]	483 [19.02]	507 [19.96]	551 [21.69]	600 [23.62]	646 [25.43]
3	L1	218 [8.58]	258 [10.16]	298 [11.73]	338 [13.31]	378 [14.88]	418 [16.46]	458 [18.03]	498 [19.61]	538 [21.18]	578 [22.76]	-
	L2	287 [11.30]	336 [13.23]	360 [14.17]	409 [16.10]	458 [18.03]	483 [19.02]	527 [20.75]	576 [22.68]	600 [23.62]	646 [25.43]	-
4	L1	266 [10.47]	306 [12.05]	346 [13.62]	386 [15.20]	426 [16.77]	466 [18.35]	506 [19.92]	546 [21.50]	586 [23.07]	-	-
	L2	336 [13.23]	385 [15.16]	409 [16.10]	458 [18.03]	483 [19.02]	527 [20.75]	576 [22.68]	622 [24.49]	646 [25.43]	-	-
5	L1	314 [12.36]	354 [13.94]	394 [15.51]	434 [17.09]	474 [18.66]	514 [20.24]	554 [21.81]	594 [23.39]	-	-	-
	L2	385 [15.16]	434 [17.09]	458 [18.03]	507 [19.96]	551 [21.69]	576 [22.68]	622 [24.49]	670 [26.38]	-	-	-
6	L1	362 [14.25]	402 [15.83]	442 [17.40]	482 [18.98]	522 [20.55]	562 [22.13]	602 [23.70]	-	-	-	-
	L2	434 [17.09]	483 [19.02]	507 [19.96]	551 [21.69]	600 [23.62]	622 [24.49]	670 [26.38]	-	-	-	-
7	L1	410 [16.14]	450 [17.72]	490 [19.29]	530 [20.87]	570 [22.44]	610 [24.02]	-	-	-	-	-
	L2	483 [19.02]	527 [20.75]	551 [21.69]	600 [23.62]	646 [25.43]	670 [26.38]	-	-	-	-	-
8	L1	458 [18.03]	498 [19.61]	538 [21.18]	578 [22.76]	-	-	-	-	-	-	-
	L2	527 [20.75]	576 [22.68]	600 [23.62]	646 [25.43]	-	-	-	-	-	-	-
9	L1	506 [19.92]	546 [21.50]	586 [23.07]	-	-	-	-	-	-	-	-
	L2	576 [22.68]	622 [24.49]	646 [25.43]	-	-	-	-	-	-	-	-
10	L1	554 [21.81]	594 [23.39]	-	-	-	-	-	-	-	-	-
	L2	622 [24.49]	670 [26.38]	-	-	-	-	-	-	-	-	-
11	L1	602 [23.70]	-	-	-	-	-	-	-	-	-	-
	L2	670 [26.38]	-	-	-	-	-	-	-	-	-	-

Weight for a PVG 32/16 valve stack
The combined weight of a PVG 32/16 valve stack can be defined like this:
(Numbers of PVB 32 x 4,42) + (numbers of PVB 16 x 3,67) + 3,6 = Weight in kg
(Numbers of PVB 32 x 9.75) + (numbers of PVB 16 x 8.09) + 7.95 = Weight in lb

Technical Information
PVG 32 Proportional Valve Group
PVG 32 Combinations Valve Stack Dimensions
PVG 100/32 Dimensions

The table of PVB 100 and PVB 32 combination valve stack dimensions overview table with accompanying drawing.

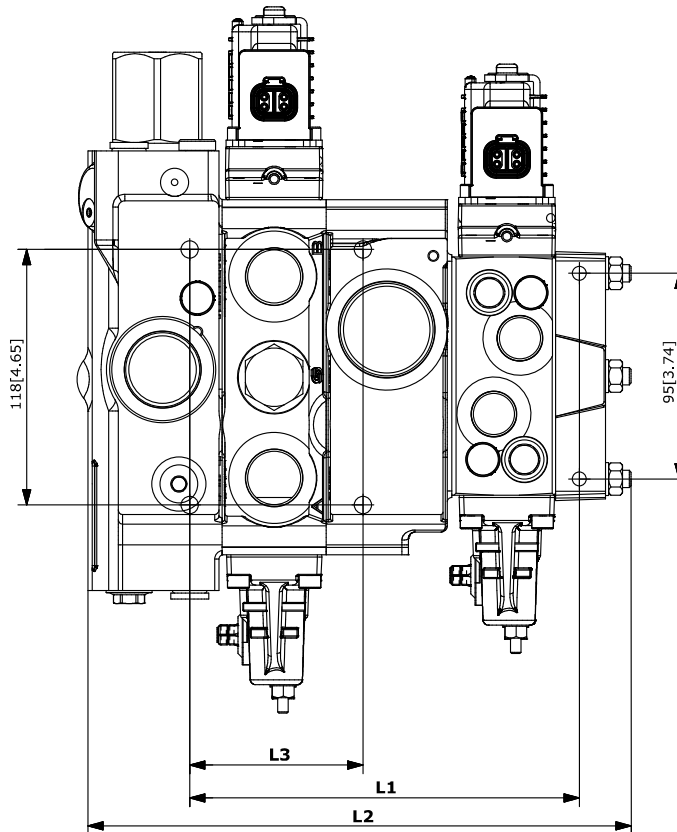

PVB 100/32 combination valve stack dimensions, mm [in]

Number of PVB 100 (down)		Number of PVB 32 modules										
		1	2	3	4	5	6	7	8	9	10	11
1	L1	168	216	264	312	360	408	456	504	552	600	648
		[6,61]	[8,50]	[10,39]	[12,28]	[14,17]	[16,06]	[17,95]	[19,84]	[21,73]	[23,62]	[25,51]
	L3	80 mm [3.15 in]										
2	L1	216	264	312	360	408	456	504	552	600	648	696
		[8,50]	[10,39]	[12,28]	[14,17]	[16,06]	[17,95]	[19,84]	[21,73]	[23,62]	[25,51]	[27,40]
	L3	128 mm [5.04 in]										
3	L1	264	312	360	408	456	504	552	600	648	696	744
		[10,39]	[12,28]	[14,17]	[16,06]	[17,95]	[19,84]	[21,73]	[23,62]	[25,51]	[27,40]	[29,29]
	L3	176 mm [6.93 in]										
4	L1	312	360	408	456	504	552	600	648	696	744	792
		[12,28]	[14,17]	[16,06]	[17,95]	[19,84]	[21,73]	[23,62]	[25,51]	[27,40]	[29,29]	[31,18]
	L3	224 mm [8.82 in]										

PVG 32 Combinations Valve Stack Dimensions
PVB 100/32 combination valve stack dimensions, mm [in] (continued)

Number of PVB 100 (down)		Number of PVB 32 modules										
		1	2	3	4	5	6	7	8	9	10	11
5	L1	360	408	456	504	552	600	648	696	744	792	840
		[14,17]	[16,06]	[17,95]	[19,84]	[21,73]	[23,62]	[25,51]	[27,40]	[29,29]	[31,18]	[33,07]
	L3	272 mm [10.71 in]										
6	L1	408	456	504	552	600	648	696	744	792	840	888
		[16,06]	[17,95]	[19,84]	[21,73]	[23,62]	[25,51]	[27,40]	[29,29]	[31,18]	[33,07]	[34,96]
	L3	320 mm [12.60 in]										
7	L1	456	504	552	600	648	696	744	792	840	888	936
		[17,95]	[19,84]	[21,73]	[23,62]	[25,51]	[27,40]	[29,29]	[31,18]	[33,07]	[34,96]	[36,85]
	L3	368 mm [14.49 in]										
8	L1	504	552	600	648	696	744	792	840	888	936	984
		[19,84]	[21,73]	[23,62]	[25,51]	[27,40]	[29,29]	[31,18]	[33,07]	[34,96]	[36,85]	[38,74]
	L3	416 mm [16.38 in]										

Weight for a PVG 100/32 valve stack
The combined weight of a PVG 100/32 valve stack can be defined like this:
(Numbers of PVB 100 x 7) + (numbers of PVB 32 x 4.42) + 10 = Weight (kg)
(Numbers of PVB 100 x 9.37) + (numbers of PVB 32 x 9.75) + 22 = Weight (lb)

Technical Information
PVG 32 Proportional Valve Group
PVG 32 Combinations Valve Stack Dimensions
PVG 120/32 Dimensions

The table of PVB 120 and PVB 32 combination valve stack dimensions overview table with accompanying drawing.

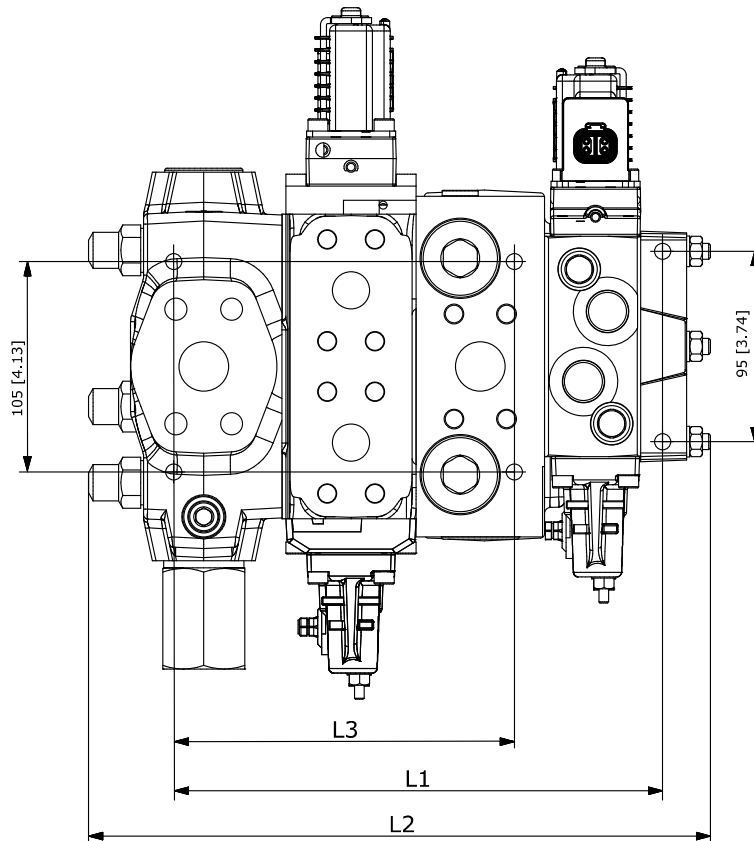

There is a horizontal difference 62.5 mm [2.46 in] in the mounting plane of the PVG 120/PVG 16. Due to the large size of the PVG 120 interface-module it is necessary to have at least one PVG 32 module between the PVGI and the first PVG 32 slice.

PVB 120/32 combination valve stack dimensions, mm [in]

Number of PVB 120 (down)		Number of PVB 32 modules										
		1	2	3	4	5	6	7	8	9	10	11
1	L1	292	340	388	436	484	532	580	628	676	724	772
		[11.50]	[13.39]	[15.28]	[17.17]	[19.06]	[20.94]	[22.83]	[24.72]	[26.61]	[28.50]	[30.39]
	L3	170 mm [6.69 in]										
2	L1	359	407	455	503	551	599	647	695	743	791	839
		[14.13]	[16.02]	[17.91]	[19.80]	[21.69]	[23.58]	[25.47]	[27.36]	[29.25]	[31.14]	[33.03]
	L3	237 mm [9.33 in]										
3	L1	426	474	522	570	618	666	714	762	810	858	906
		[16.77]	[18.66]	[20.55]	[22.44]	[24.33]	[26.22]	[28.11]	[30.00]	[31.89]	[33.78]	[35.67]
	L3	304 mm [11.91 in]										

PVG 32 Combinations Valve Stack Dimensions
PVB 120/32 combination valve stack dimensions, mm [in] (continued)

Number of PVB 120 (down)		Number of PVB 32 modules										
		1	2	3	4	5	6	7	8	9	10	11
4	L1	493	541	589	637	685	733	781	829	877	925	973
		[19.41]	[21.30]	[23.19]	[25.08]	[26.97]	[28.86]	[30.75]	[32.64]	[34.53]	[36.42]	[38.31]
	L3	371 mm [14.61 in]										
5	L1	560	608	656	704	752	800	848	896	944	992	1040
		[22.05]	[23.94]	[25.83]	[27.72]	[29.61]	[31.50]	[33.39]	[35.28]	[37.17]	[39.06]	[40.94]
	L3	438 mm [17.24 in]										
6	L1	627	675	723	771	819	867	915	963	1011	1059	1107
		[24.69]	[26.57]	[28.46]	[30.35]	[32.24]	[34.13]	[36.02]	[37.91]	[39.80]	[41.69]	[43.58]
	L3	505 mm [19.88 in]										
7	L1	694	742	790	838	886	934	982	1030	1078	1126	1174
		[27.32]	[29.21]	[31.10]	[32.99]	[34.88]	[36.77]	[38.66]	[40.55]	[42.44]	[44.33]	[46.22]
	L3	572 mm [22.52 in]										
8	L1	761	809	857	905	953	1001	1049	1097	1145	1193	1241
		[29.96]	[31.85]	[33.74]	[35.63]	[37.52]	[39.41]	[41.30]	[43.19]	[45.08]	[46.97]	[48.86]
	L3	639 mm [25.16 in]										

Weight for a PVG 120/32 valve stack
The combined weight of a PVG 120/32 valve stack can be defined like this:
(Numbers of PVB 120 x 13.5) + (numbers of PVB 32 x 4.42) + 11.5 = Weight (kg)
(Numbers of PVB 120 x 29.76) + (numbers of PVB 32 x 9.75) + 25.4 = Weight (lb)

Technical Information
PVG 32 Proportional Valve Group
PVG 32 Combinations Valve Stack Dimensions
PVG 128/32 Dimensions

The table of PVB 128 and PVB 32 combination valve stack dimensions overview table with accompanying drawing.

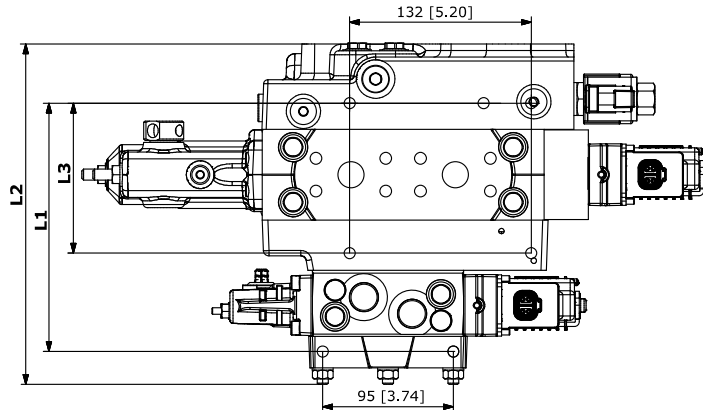

PVB 128/32 combination valve stack dimensions, mm [in]

Number of PVB 128 (down)		Number of PVB 32 modules										
		1	2	3	4	5	6	7	8	9	10	11
1	L1	181 [7.13]	229 [9.02]	277 [10.91]	325 [12.80]	373 [14.69]	421 [16.57]	469 [18.46]	517 [20.35]	565 [22.24]	613 [24.13]	661 [26.02]
	L2	249.5 [9.82]	297.5 [11.71]	346.5 [13.64]	394.5 [15.53]	417.5 [16.44]	443.5 [17.46]	540.5 [21.28]	588.5 [23.17]	637.5 [25.10]	685.5 [26.99]	734.5 [28.92]
	L3	98,5 mm [3.88 in]										
2	L1	247,0 [9,72]	295,0 [11,61]	343,0 [13,50]	391,0 [15,39]	439,0 [17,28]	487,0 [19,17]	535,0 [21,06]	583,0 [22,95]	631,0 [24,84]	-	-
	L2	321,5 [12,66]	370,5 [14,59]	418,5 [16,48]	467,5 [18,41]	515,5 [20,30]	564,5 [22,22]	612,5 [24,11]	661,5 [26,04]	709,5 [27,93]	-	-
	L3	164,5 mm [6.48 in]										
3	L1	313,0 [12,32]	361,0 [14,21]	409,0 [16,10]	457,0 [17,99]	505,0 [19,88]	553,0 [21,77]	601,0 [23,66]	649,0 [25,55]	-	-	-
	L2	382,5 [15,06]	431,5 [16,99]	479,5 [18,88]	528,5 [20,81]	576,5 [22,70]	625,5 [24,63]	673,5 [26,52]	722,5 [28,44]	-	-	-
	L3	230,5 mm [9.07 in]										
4	L1	379,0 [14,92]	427,0 [16,81]	475,0 [18,70]	523,0 [20,59]	571,0 [22,48]	619,0 [24,37]	667,0 [26,26]	-	-	-	-
	L2	455,5 [17,93]	503,5 [19,82]	552,5 [21,75]	600,5 [23,64]	649,5 [25,57]	697,5 [27,46]	746,5 [29,39]	-	-	-	-
	L3	296,5 mm [11.67]										
5	L1	445,0 17,52	493,0 19,41	541,0 21,30	589,0 23,19	637,0 25,08	-	-	-	-	-	-
	L2	515,5 [20,30]	564,5 [22,22]	612,5 [24,11]	661,5 [26,04]	709,5 [27,93]	-	-	-	-	-	-
	L3	362,5 mm [14.27]										

PVG 32 Combinations Valve Stack Dimensions
PVB 128/32 combination valve stack dimensions, mm [in] (continued)

Number of PVB 128 (down)		Number of PVB 32 modules										
		1	2	3	4	5	6	7	8	9	10	11
6	L1	511,0 20,12	559,0 22,01	607,0 23,90	655,0 25,79	-	-	-	-	-	-	-
	L2	588,5 [23,17]	637,5 [25,10]	685,50 [26,99]	734,50 [28,92]	-	-	-	-	-	-	-
	L3	428,5 mm [16.87]										
7	L1	577,0 22,72	625,0 24,61	673,0 26,50	-	-	-	-	-	-	-	-
	L2	649,5 [25,57]	697,5 [27,46]	746,5 [29,39]	-	-	-	-	-	-	-	-
	L3	494,5 mm [19.47]										
8	L1	643,0 25,31	-	-	-	-	-	-	-	-	-	-
	L2	722,50 [28,44]	-	-	-	-	-	-	-	-	-	-
	L3	560,5 mm [22.07]										

Weight for a PVG 128/32 valve stack

The weight is for a combined PVG 128/32 valve stack with a PVEO Series 7 on each working section and is only approximate, can be defined like this:

$$(\text{Numbers of PVB 128} \times 16.9) + (\text{numbers of PVB 32} \times 4.42) + 17.5 = \text{Weight (kg)}$$

$$(\text{Numbers of PVB 128} \times 37.26) + (\text{numbers of PVB 32} \times 9.75) + 38.6 = \text{Weight (lb)}$$

Technical Information
PVG 32 Proportional Valve Group
PVG 32 Combinations Valve Stack Dimensions
PVG 256/32 Dimensions

The table of PVB 256 and PVB 32 combination valve stack dimensions overview table with accompanying drawing.

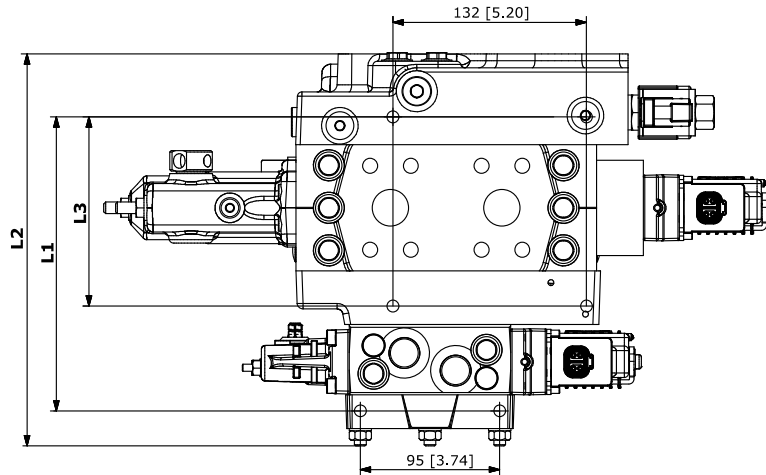

PVB 256/32 combination valve stack dimensions, mm [in]

Number of PVB 256 (down)		Number of PVB 32 modules									
		1	2	3	4	5	6	7	8	9	10
1	L1	201 [7.91]	249 [9.80]	297 [11.69]	345 [13.58]	393 [15.47]	441 [17.36]	489 [19.25]	537 [21.14]	585 [23.03]	633 [24.92]
	L2	273,5 [10.77]	321,5 [12.66]	370,5 [14.59]	418,5 [16.48]	467,5 [18.41]	515,5 [20.30]	564,5 [22.22]	612,5 [24.11]	661,5 [26.04]	709,5 [27.93]
	L3	118,5 mm [4.67 in]									
2	L1	287 [11.30]	335 [13.19]	383 [15.08]	431 [16.97]	479 [18.86]	527 [20.75]	575 [22.64]	623 [24.53]	671 [26.42]	–
	L2	358,5 [14.11]	406,5 [16.0]	455,5 [17.93]	503,5 [19.82]	552,5 [21.75]	600,5 [23.64]	649,5 [25.57]	697,5 [27.46]	746,5 [29.9]	–
	L3	204,5 mm [8.05 in]									
3	L1	373 [14.69]	421 [16.57]	469 [18.46]	517 [20.35]	565 [22.24]	613 [24.13]	661 [26.02]	–	–	–
	L2	443,5 [17,46]	491,5 [19,35]	540,5 [21,28]	588,5 [23,17]	637,5 [25,10]	685,5 [26,99]	734,5 [28,92]	–	–	–
	L3	290,5 mm [11.44 in]									
4	L1	459 [18,07]	507 [19,96]	555 [21,85]	603 [23,74]	651 [25,63]	–	–	–	–	–
	L2	528,5 [20,81]	576,5 [22,70]	625,5 [24,63]	673,5 [26,52]	722,5 [28,44]	–	–	–	–	–
	L3	376,5 mm [14.82 in]									
5	L1	545 [21,46]	593 [23,35]	641 [25,24]	–	–	–	–	–	–	–
	L2	625,5 [24,63]	673,5 [26,52]	722,5 [28,44]	–	–	–	–	–	–	–
	L3	462,5 mm [18.21 in]									

PVG 32 Combinations Valve Stack Dimensions
PVB 256/32 combination valve stack dimensions, mm [in] (continued)

Number of PVB 256 (down)		Number of PVB 32 modules									
		1	2	3	4	5	6	7	8	9	10
6	L1	631 [24,84]	-	-	-	-	-	-	-	-	-
	L2	709,5 [27,93]	-	-	-	-	-	-	-	-	
	L3	548,5 mm [21.59 in]									

Weight for a PVG 256/32 valve stack

The weight is for a combined PVG 256/32 valve stack with a PVEO Series 7 on each working section and is only approximate, can be defined like this:

(Numbers of PVB 256 x 20,9) + (numbers of PVB 32 x 4,42) + 17.5 = Weight (kg)

(Numbers of PVB 256 x 46.08) + (numbers of PVB 32 x 9.75) + 38.6 = Weight (lb)

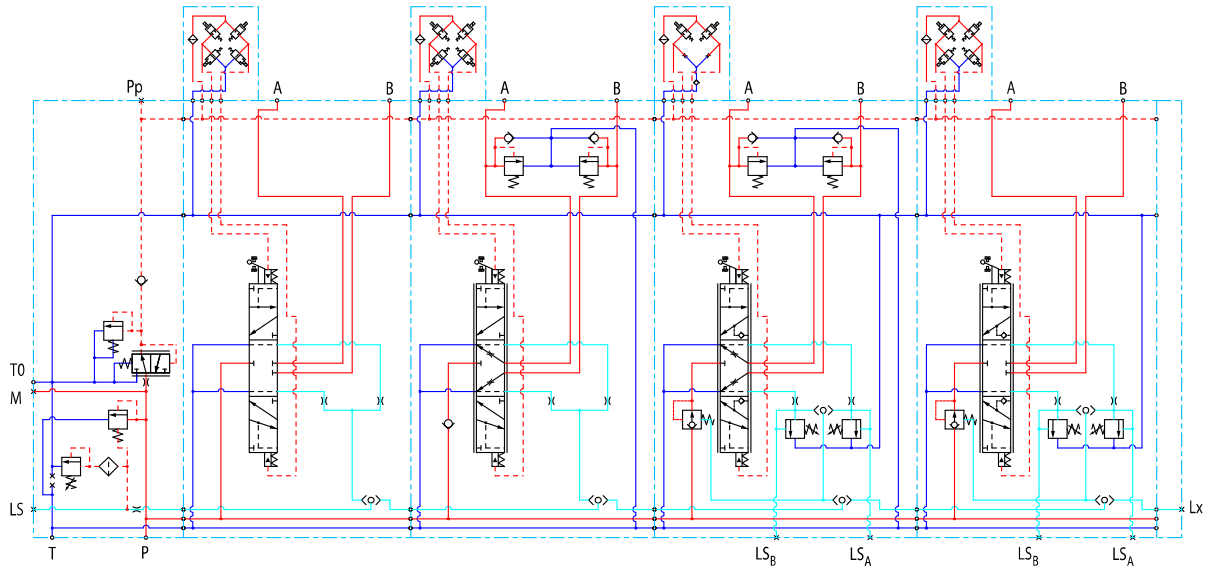
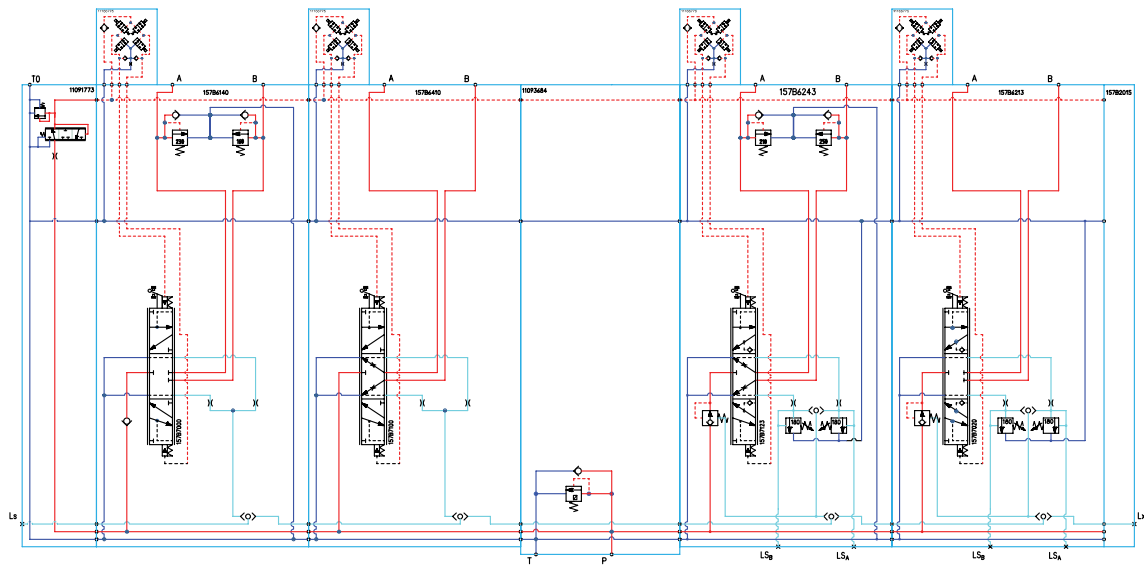
Technical Information
PVG 32 Proportional Valve Group
PVG schematic and specification examples
Schematics
PVG with open center PVP for fixed displacement pumps schematic

PVG with Open/Closed center PVP schematic



 Technical Information
PVG 32 Proportional Valve Group
PVG schematic and specification examples
Specifications

PVG with open center PVP for fixed displacement pumps specification

 Specification Sheet
 Valve type:

PVG 32

Subsidiary / Dealer	Danfoss Sold-To Party No.		Customer	
Valve No.	Customer Part No.		Application	
Filled in by	Date	Revision No	EAU	
Function	A-Port		B-Port	
1 Inlet		157B5130 200	PVP32 bar	
2 Work section 25l/min Closed neutral	PVM32 157B3171	157B6410	PVB32 bar	157B7001 PVBS32 11166838 PVEO
3 Work section 25l/min Open neutral	PVM32 157B3171 PVLP 157B2230	157B6140	PVB32 bar	157B7101 PVBS32 11166775 PVEH 157B2160 PVLP
4 Work section 65l/min Open neutral	PVM32 157B3171 PVLP 157B2210	157B6243 180	PVB32 bar	157B7123 PVBS32 11177347 PVEA 157B2250 PVLP
5 Work section 40l/min Closed neutral	PVM32 157B3171	157B6213 150	PVB32 bar	157B7022 PVBS32 11166732 PVEH
6		157B2015	PVS32 bar	
7		LSA=	bar	LSB= bar
8		LSA=	bar	LSB= bar
9		LSA=	bar	LSB= bar
10		LSA=	bar	LSB= bar
11		LSA=	bar	LSB= bar
12		LSA=	bar	LSB= bar
13		LSA=	bar	LSB= bar
14		LSA=	bar	LSB= bar
15		LSA=	bar	LSB= bar
18 Assembly Kit	1. 157B8004	2.	3.	Business Type:
19 Painting (write no if paint not wanted)		No	No paint	New Business
20 Customer Text on Group Label				PVE Programming:
21 Customer Text on Packaging Label (Box)				No
22 Comment:				EX Certification:
				None

Technical Information
PVG 32 Proportional Valve Group
PVG schematic and specification examples
PVG with Open/Closed center PVPM specification

 Specification Sheet
 Valve type:

PVG 32

Subsidiary / Dealer	Danfoss Sold-To Party No.		Customer	
Valve No.	Customer Part No.		Application	
Filled in by	Date	Revision No	EAU	
Function	A-Port		B-Port	
1 Start Plate w. Pilot pressure		11091773	PVS132	
			bar	
2 Work Section 10l/min closed neutral	PVM32 157B3171 PVLP 157B2230	157B6140	PVB32	157B7000 PVBS32 11166775 PVEH 157B2160 PVLP
		LSA=	bar LSB=	bar
3 Work Section 10l/min open neutral	PVM32 157B3171	157B6410	PVB32	157B7100 PVBS32 11166775 PVEH
		LSA=	bar LSB=	bar
4 Mid Inlet w. shock valve	PVLP 157B2280	11093684	PVPM32	
		LSA=	bar LSB=	bar
5 Work Section 65l/min open neutral	PVM32 157B3171 PVLP 157B2210	157B6243 180	PVB32	157B7123 PVBS32 11166775 PVEH 157B2250 PVLP
		LSA=	bar LSB=	180 bar
6 Work Section 10l/min closed neutral	PVM32 157B3171	157B6213 180	PVB32	157B7020 PVBS32 11166775 PVEH
		LSA=	bar LSB=	180 bar
7 End Plate		157B2015	PVS32	
		LSA=	bar LSB=	bar
8		LSA=	bar LSB=	bar
9		LSA=	bar LSB=	bar
10		LSA=	bar LSB=	bar
11		LSA=	bar LSB=	bar
12		LSA=	bar LSB=	bar
13		LSA=	bar LSB=	bar
14		LSA=	bar LSB=	bar
15		LSA=	bar LSB=	bar
18 Assembly Kit	1. 157B8024	2.	3.	Business Type:
19 Painting (write no if paint not wanted)		No	No paint	New Business
20 Customer Text on Group Label				PVE Programming:
21 Customer Text on Packaging Label (Box)				No
22 Comment:				EX Certification:
				None

Products we offer:

- Cartridge valves
- DCV directional control valves
- Electric converters
- Electric machines
- Electric motors
- Gear motors
- Gear pumps
- Hydraulic integrated circuits (HICs)
- Hydrostatic motors
- Hydrostatic pumps
- Orbital motors
- PLUS+1® controllers
- PLUS+1® displays
- PLUS+1® joysticks and pedals
- PLUS+1® operator interfaces
- PLUS+1® sensors
- PLUS+1® software
- PLUS+1® software services, support and training
- Position controls and sensors
- PVG proportional valves
- Steering components and systems
- Telematics

Hydro-Gear

www.hydro-gear.com

Daikin-Sauer-Danfoss

www.daikin-sauer-danfoss.com

Danfoss Power Solutions is a global manufacturer and supplier of high-quality hydraulic and electric components. We specialize in providing state-of-the-art technology and solutions that excel in the harsh operating conditions of the mobile off-highway market as well as the marine sector. Building on our extensive applications expertise, we work closely with you to ensure exceptional performance for a broad range of applications. We help you and other customers around the world speed up system development, reduce costs and bring vehicles and vessels to market faster.

Danfoss Power Solutions – your strongest partner in mobile hydraulics and mobile electrification.

Go to www.danfoss.com for further product information.

We offer you expert worldwide support for ensuring the best possible solutions for outstanding performance. And with an extensive network of Global Service Partners, we also provide you with comprehensive global service for all of our components.

Local address:

Danfoss Power Solutions (US) Company
2800 East 13th Street
Ames, IA 50010, USA
Phone: +1 515 239 6000

Danfoss Power Solutions GmbH & Co. OHG
Krokamp 35
D-24539 Neumünster, Germany
Phone: +49 4321 871 0

Danfoss Power Solutions ApS
Nordborgvej 81
DK-6430 Nordborg, Denmark
Phone: +45 7488 2222

Danfoss Power Solutions Trading (Shanghai) Co., Ltd.
Building #22, No. 1000 Jin Hai Rd
Jin Qiao, Pudong New District
Shanghai, China 201206
Phone: +86 21 2080 6201

Danfoss can accept no responsibility for possible errors in catalogues, brochures and other printed material. Danfoss reserves the right to alter its products without notice. This also applies to products already on order provided that such alterations can be made without subsequent changes being necessary in specifications already agreed. All trademarks in this material are property of the respective companies. Danfoss and the Danfoss logotype are trademarks of Danfoss A/S. All rights reserved.